



MixW is state of the art digital mode software by:  
Nick Fedoseev, UT2UZ, and Denis Nechitailov, UU9JDR.

Help for MixW3.1.1

## **\*OVERVIEW OF MIXW**

---

1. [Welcome to MixW](#) -- Information about the Program
2. [Quick Start](#) -- For experienced digital mode users
3. [Registration](#) -- How to become a registered user
4. [Using the MixWHelp System](#) -- Finding Information!

## **Welcome**

---

The Demo version of the MixW program is good for 15 days. For registration information please see [Registration](#)

There are 5 sections in MixWHelp:

This overview is Section 1. To download sections 2 - 5 please see: [Using MixWHelp](#)

---

MixW stands for a Mixture of different modes. MixW now fully supports CW, BPSK31, QPSK31, BPSK63 & 125, MFSK, RTTY, FSK31, Packet (HF and VHF including TCP/IP over AX25), Pactor RX/TX (TX requires TNC), Amtor (Sitor) TX/RX (No TNC needed), Hellschreiber, FAX (RX only), SSTV, THROB, and MT63. In addition to these built-in modes, new modes can be added to MixW using a facility called "External mode plugin support". The first example of a plugin mode was Olivia, which was included in the 2.16 release package. Additional plugin modes now available are Contestia and RTTYM.

MixW supports WinKeyer and a number of different manufacturers Rotors.

MixW also includes support for multimode TNCs for those preferring a hardware-based approach to the digital modes. Even more modes can be accessed by configuring MixW to call other software packages from within MixW.

Other MixW features include a voice keyer for SSB, FM, and AM phone modes. Excellent logging, QSO scheduling and reminding, and even auto CQing of scheduled events through the fully configurable MACROS. There is also a sophisticated contest mode facilitating competitive digital mode contest operation, and an export of the contest log to the newly required Cabrillo format. The log will import and export CSV and ADIF files. MixW has support for printing custom QSL cards or labels and automatic sending of QSO data to eQSL. There is built in DX Cluster support either via Packet Radio or the internet.

MixW does not require a TNC to operate. The requirement to run MixW2.19 and earlier is you have a computer running Windows 9x, ME, NT, 2000, XP, Vista, Windows 7, Windows 8 or Windows 10 operating system, either 32 or 64 bit can be used and a compatible soundcard. MixW2.2 or MixW3 requires an operating system of Windows2000 or later.

If you are experienced with the sound card modes you can just go straight to the [Quick Start](#).

If you are new to SoundCard digital mode operation, you will need to connect your radio's transmit and receive audio to your computer soundcard via the mic or line input, and the headphone or line output. You will also need to provide for transmit keying by PTT or some other method.

The following site is recommended for additional information about interfacing your radio with the computer. First go to:

Understanding Soundcard Interfacing, by Ernie Mills, WM2U:  
<http://www.qsl.net/wm2u/interface.html>

to get an overview of the subject. Then if you are a home brew ham, just get to work and build an interface. If you are an appliance type there are plenty of plug-and-play interfaces. Follow any of the links on Ernie Mills' site above, use your favorite search engine, or check amateur radio magazines for the latest information.

---

### *AND NOW A WORD FROM OUR SPONSORS*

For the latest MixW software and related information, visit the MixW websites at:

<http://www.mixw.net>

and

<http://www.mixwusa.com/>

For the latest version of MixWHelp and to keep up to date on the status of MixW join the MixW reflector at:

<http://groups.yahoo.com/group/MixW/>

---

Original MixWHelp by **Scott Hill, K6IX**  
with many thanks to the following contributors:

**Scott E Thile, K4SET**

**Denis Nechitailov, UU9JDR**

**Howard (Skip) Teller, KH6TY**

**Richard B. Griffen, NB6Z**

**Jim Jaffe, WA2VOS**

**Finn Helmuth Pedersen, OZ6LI**

**Bob Parker, K4PPN**

**Pat De Wever ON2AD**

MixW3.1 Help adapted by Colin Bell 2E0BPP

---

To learn more about using MixWHelp, see [Using MixWHelp](#).

If you have any concerns or comments about the contents of MixWHelp contact:

## Quick Start

---

A brief outline for configuring and operating MixW for experienced sound card digital mode users. For the full MixWHelp suite see: [Using MixWHelp](#)

If your station is already interfaced and configured for SoundCard digital software, and you're an experienced operator with the SoundCard digital modes, then all you need to do to get on the air with MixW is:

- **Install the software**
  - **Configure your Personal Data**
  - **Configure your Transceiver PTT settings**
  - **Review the commands for basic operation**
  - **GOTA! (Get on the Air)!**
- 

### Install the software:

The program download is a self extracting installation file.

From Windows XP onwards the operating system is built in either 32 or 64 bit format. MixW, which is only released in 32 bit format, will run on either formats the only difference is during the install if a default installation is being performed. The program files are installed in C:\Program Files\MixW\ on 32 bit systems but in C:\Program Files (X86)\MixW\ on 64 bit systems.

Up to Mixw V2.19 you can choose any directory you would like, or use the default directory of C:\Program Files\MixW\ for 32 bit systems or C:\Program Files (X86)\MixW\ for 64 bit systems

For Mixw2.2 and Mixw3 the installation has two parts, the program files which will be installed into the [default](#)

For 32 bit Windows installation C:\Program Files\MixW\

For 64 bit Windows installation C:\Program Files (X86)\MixW\

program files directory unless the selection is changed on the installation screen and the data files which can be installed into any directory of your choice or by default:

for windows XP:

C:\documents and settings\{your\_username}\Application Data\Mixw\

for windows Vista, Windows 7, Windows 8 or Windows 10:

c:\users\{your\_username}\Appdata\Roaming\Mixw\

**Make sure you remember the directories you installed the program and data files in. Windows does not always display full pathnames which can lead to 'lost' files or using the 'wrong' file.**

The extraction procedure will automatically install all the files MixW needs to run on your system. The most important files for you to know about are:

MixW2.exe (the main program file for V2) or MixW3.exe (the main program file for V3)

CmnData.dll (program information)  
[bands.ini](#) (default band frequency information)  
contest.mc (contest macros)  
[cty.dat](#) (antenna heading system)  
[pfx.dat](#) (prefix id file)

Other files are automatically created by MixW which are:

[MixW2.log](#) (default log file - **be sure to back up often!**)  
[MixW2.ini](#) (saves your configuration - **back up often**)  
[MixMacros.ini](#) (default macro file created when you first modify a macro)

As you learn to use new features of MixW you will create new files, particularly for your mode specific macros. These files will have a .mc or .ini extension.

**Be sure to back up all of your \*.mc and \*.ini files, as well as your .log files.**

Up to Mixw2.19 if you have registered MixW, make a copy of your MixWReg1.dll file and paste it into your MixW folder.

Mixw2.2 and Mixw3 do not use a registration file. Registration is achieved by connecting to the internet and then selecting the Menu Help->Apply registration.

---

**In early versions of MixW Help from the menu bar was not always visible.**

**Mixw uses two different menu layouts. If Help is not available change your menus to look like this:**



**If the Help menu is not visible in the main Mixw menu bar, select:**

**View | Menu and choose Layout 1.**

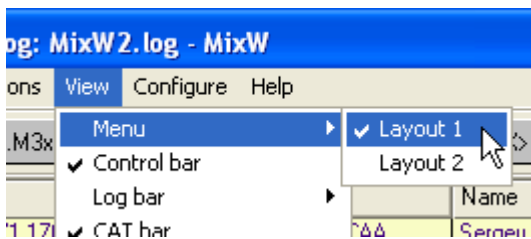

---

**Configure your Personal Data:** Select Configure | Personal Data. This will display the following dialog box:



Enter your Station information and select your CW ID options, then click OK. (Your callsign should be in ALL CAPS).

### Configure your Transceiver PTT settings:

If you are using VOX to trigger TX/RX function, and you are not using CAT features you can ignore this section entirely and go directly to the Commands for basic operation.

If you are triggering TX/RX with a PTT circuit, or CAT control, you will need to configure MixW to key your transceiver. To do so Select: Configure | TRCVR CAT/PTT. This will display the following dialog box:

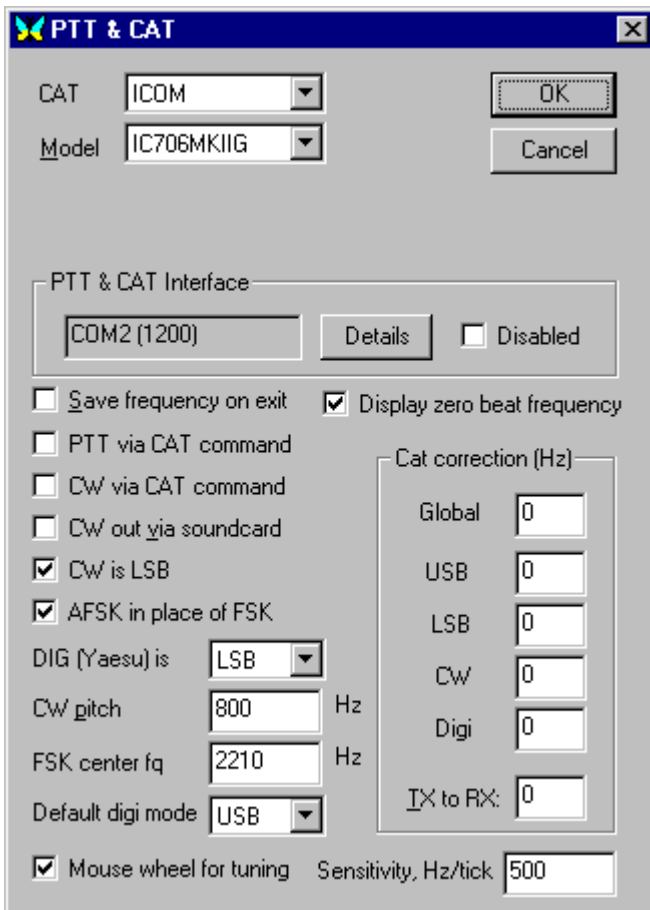

This dialog box is for the PTT and/or CAT features. If you will not be using the CAT function, set TRCVR to "None", ignore the rest of this dialog, and click on "Details" to configure your PTT COM port options.

If you will be using CAT for PTT, first select your transceiver make and model from the drop down menus. (**Note:** if your model is not listed, try a similar model of the same make. For instance, almost all CAT capable Kenwoods work with the TS-850 setting). Next, check PTT via CAT command box, then click on "Details" to configure your CAT COM port options.

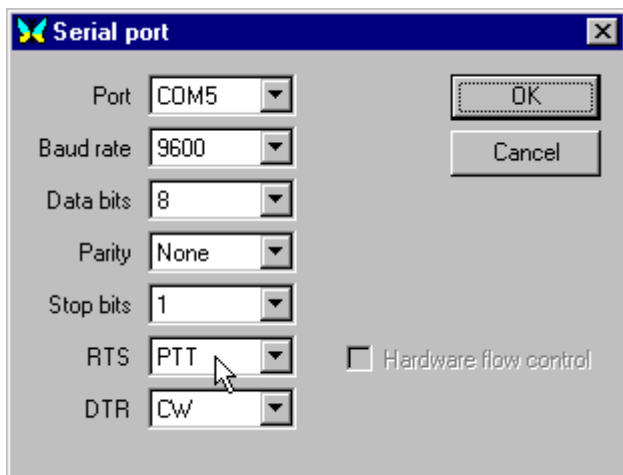

Select the COM port you will be using. If you are using this port for PTT only, then only the COM port number and the RTS/DTR settings apply. If you are using this port for CAT PTT then set the port to match the requirements of your transceiver for CAT.

If you want to use one COM port for CAT and another for PTT, first configure the CAT/PTT port for CAT, then choose: Configure | Secondary PTT port | Port Settings to set the secondary COM port for PTT.

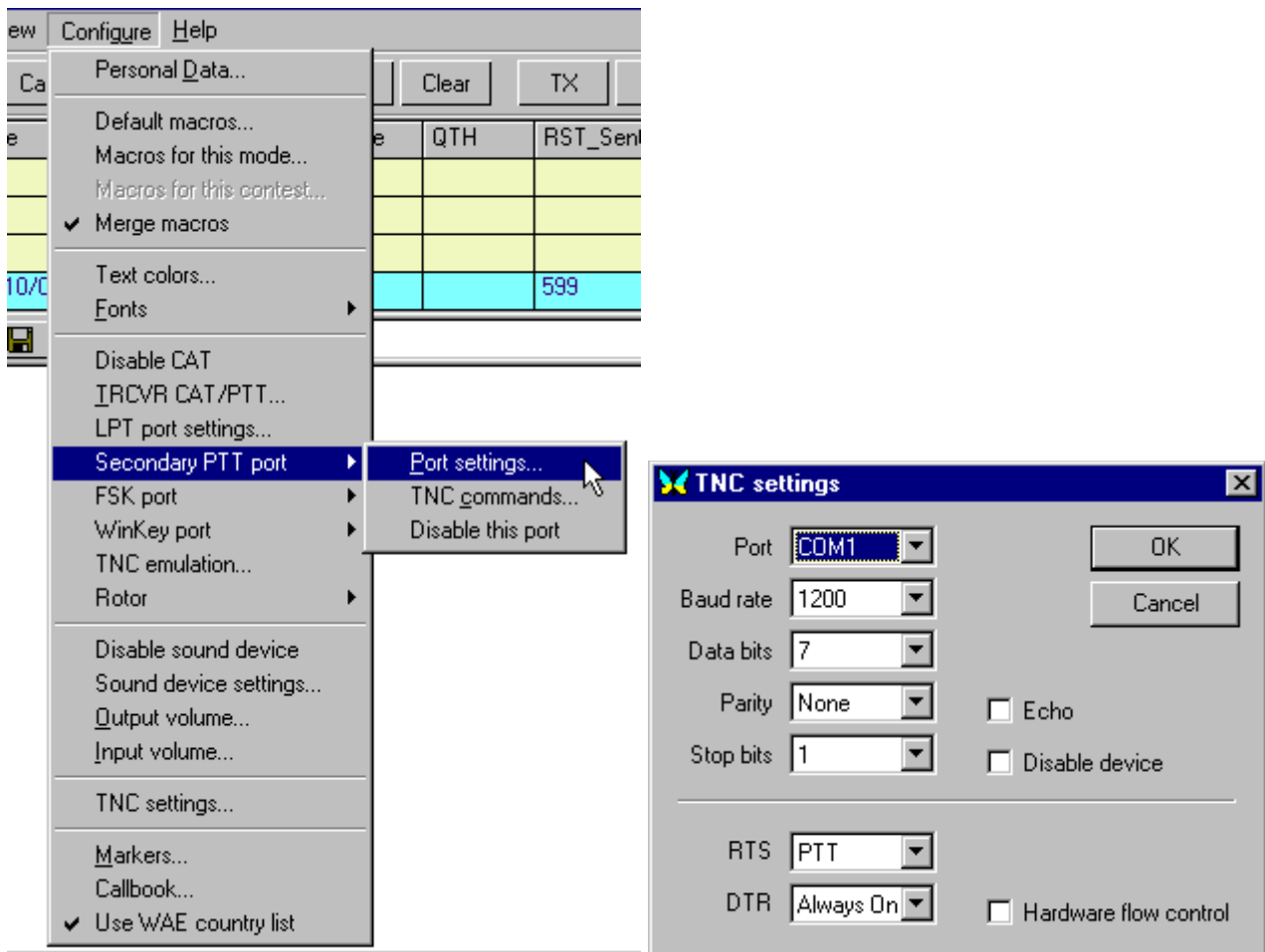

---

## Commands for basic operation:

### Mode selection

Select the mode you wish to operate by clicking Mode | your choice of mode:

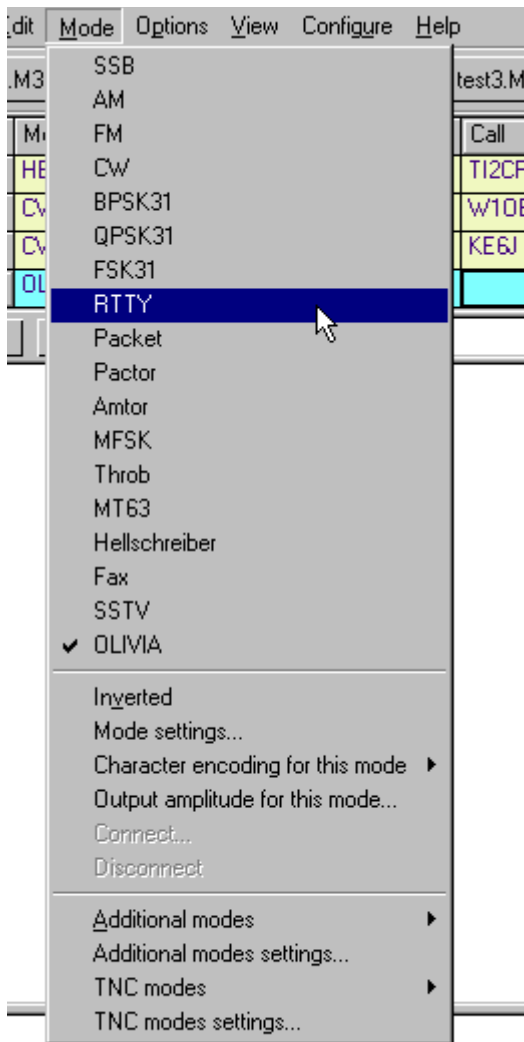

You can also switch modes by clicking on the mode box in the status bar and selecting the mode you wish to operate from the pop up menu:

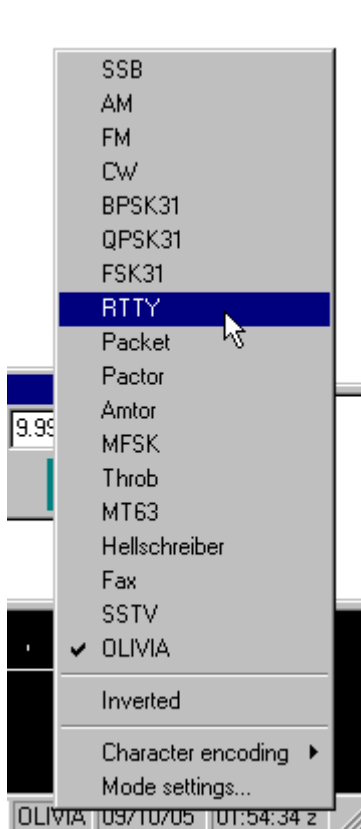



**Switching between TX and RX:** There are several ways to switch MixW between TX and RX. The Pause/Break key (on the computer keyboard) will toggle TX/RX. You can also toggle TX/RX by clicking on the TX/RX box in the Status Bar, or by using the TX and RX buttons on the Macro Bar (depending on your Macro Setting).

**Panic Button:** Pressing the "Esc" key twice will immediately stop Transmission. Text remaining in the TX window will NOT be sent.

### Positioning and Sizing Windows

Pointing to a vacant space on the Control Bar, Log Bar, Tuning Indicator, or any of the other "Dockable" windows and holding the left mouse button down while moving the mouse makes it possible to reposition and dock any of these features. An outline of the feature will appear when the mouse is first moved, and when that outline shrinks, it indicates a position where the feature may be placed by releasing the mouse button. The docked position of the feature will be remembered from session to session in the MixW2.ini file.

Pointing to a window separator will cause the mouse cursor to change to a small pair of parallel lines, and pressing the left mouse button and keeping it pressed will make it possible to resize the Spectrum, TX or RX windows. Releasing the mouse button will leave the window in the resized position.

The following screen indicates one approach to screen layout using the various MixW displays:

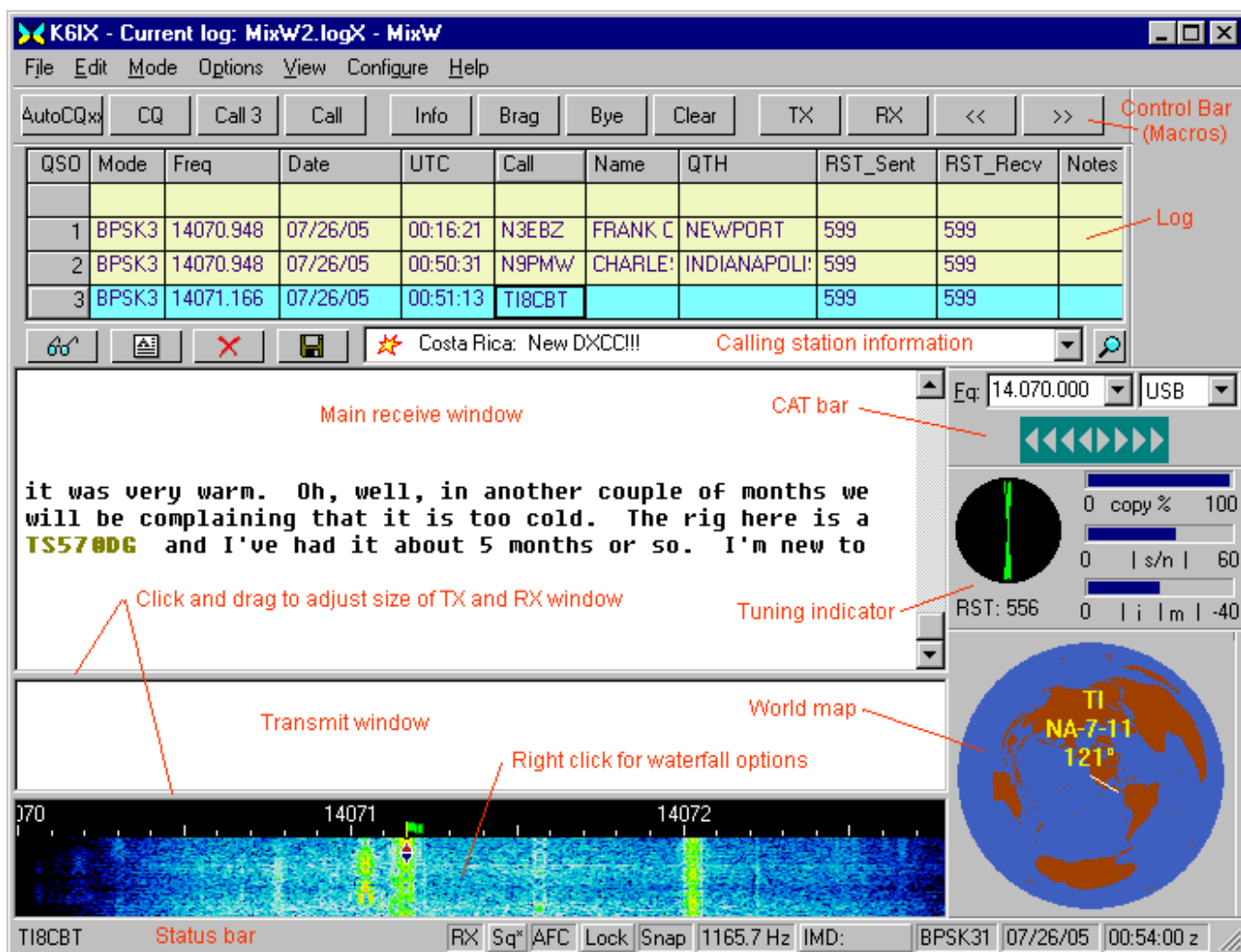

Notice that the status bar will change according to the options and features specific to the mode you have selected, and the mode will be indicated in the mode box. For instance, IMD is only relevant in the PSK modes, while Connected or Disconnected is only relevant for the connected modes:

Rx Sq\* AFC Lock Snap 1725.3 Hz IMD: -25 dB BPSK3F 01/28/2001 16:14:05

Disconnected DCD AFC Lock Snap 1367.0 Hz PACKET 01/28/2001

### Opening Multiple RX Windows

To open additional RX windows, right click on a signal in the waterfall and select: New RX window. To TX on the frequency of a secondary RX window, right click on the secondary window and select: Swap. The primary RX window will be swapped with the selected secondary window and then RX can be initiated on that frequency.

---

These basic commands will suffice to get you on the air with MixW's default settings in most of the modes, however, there are many user configurable settings to refine and improve your operation. To learn more about general operating settings, as well as settings for the specific modes offered in MixW, see the Welcome and Using MixWHelp topics for information on other MixWHelp modules.

**The Demo version of MixW is good for 15 days. For registration information click [Registration](#).**

## Registration

---

**The Demo version of MixW is good for 15 days. There are no other restrictions on the demo.**

**The Registration Fee for MixW2x is \$50 USD.**

To **register and pay online**, up to MixW2.19 please visit: <http://www.mixw.net>

---

**US Stations who wish to register by mail** should send Cash, Check, or Money order (Payable to Jim Jaffe) to:

Jim Jaffe, WA2VOS  
141-08 71 Road  
Flushing, NY 11367-1945.

Overseas Stations should send US funds, either Cash or International Money Order.

Non-US Checks and Credit Cards are not accepted.

A registration form can be downloaded from: <http://www.mixwusa.com/>

---

When your registration is received you will be sent a special registration file via EMAIL which will stop the timer in the downloaded program.

A dual registration can be issued provided that the second call is either the user's own MARS call, another personal call issued by a different country, or another member of the Immediate household living at the same address (confirmed by a callbook).

A CD can also be ordered (for an additional fee) from Jim Jaffe's site.

---

For MixW2.2 the cost is the same as for MixW2.19 but for MixW3 an upgrade from MixW2.x is an additional \$20 US Dollars or an outright purchase it is \$70 US Dollars (or equivalent in Euros or pounds Sterling, depends on the payment site).

To download MixW2.2 or MixW3 either use <http://www.mixwusa.com/> and follow the download links or go to <http://www.mixw.net>, and click on Download MixW 2.20f or Download MixW3.1.1 for whichever version is required.

To check if you are registered click on the Check Registration green tick. If you choose to purchase by this method you will be taken through an online purchase procedure with Digital River GmbH (Share-it).

Once you have purchased MixW2.2 or MixW3, by whatever means, to register MixW ensure you have an internet connection, start MixW, fill in your callsign detail and save it. MixW may be automatically registered but to make certain select Help menu.

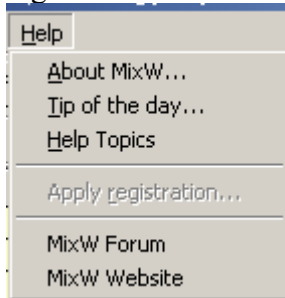

If the Apply registration is greyed out MixW is registered. If not click on Apply registration... If after 24 hours registration has not been achieved contact either MixW in Ukraine, using the contact address on the mixw.net web site or Jim Jaffe using the email address on mixwusa.com website.

Once registration has been achieved MixW can then be used with or without immediate internet access. The registration information is copied to the Windows registry.

**For additional registration information visit:**

<http://www.mixw.net>

and

<http://www.mixwusa.com/>

## Using MixW Help

---

**In early versions of MixW Help from the menu bar was not always visible.**

**Mixw uses two different menu layouts. If Help is not available change your menus to look like this:**

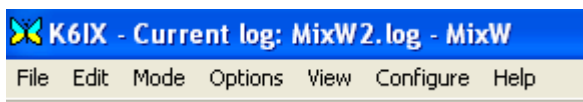

**If the Help menu is not visible in the main Mixw menu bar, select:**

**View | Menu and choose Layout 1.**

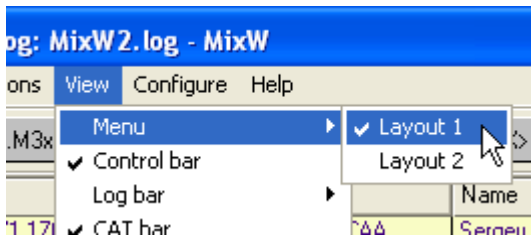

MixWHelp can provide you with very powerful methods to help you find the information you are looking for, if you take just a moment to learn to use the tools available.

**FIRST:** Notice that the Table of Contents stays visible under the Contents tab in the left panel while you are viewing the contents of the topic in the right panel. The name of the topic you are viewing is highlighted so you can keep track of where you are in the file.

**Note:** A red star on the topic symbol  in the Contents indicates a new topic, or a topic with major modifications.

**SECOND:** The Search tab provides a full text search which will find, and highlight, every occurrence of a word. This not only helps you find the topics where a subject is discussed, but makes it easy to locate the word within the topic by looking for the highlight.

**THIRD:** Use the Back and Forward buttons at the top of the Help window when you return to topics you have been reading. The Back and Forward buttons will take you to the position in the topic from which you left, rather than back to the top of the topic.

**FOURTH:** MixWHelp has 5 modules, each of which can be downloaded individually, so that you only need to download the modules you want, or the modules which have been updated. After downloading unzip and place the modules you want to use, up to MixW2.19 in the MixW folder, for MixW2.20 and later in the data folder. All modules are optional except the Overview of MixW module (which is included in the program release package).

### **Blocked Files.**

Windows XP and later Windows versions may mark the imported files as a security risk. If you are not able to access a downloaded and unzipped file, start Windows Explorer and navigate to the inaccessible file and right click on the file. Then left click on Properties at the bottom of the menu. In the Properties dialog box look at the bottom for a statement like: "Security: This file came from another computer and might be blocked to help protect this computer". Click the Unblock button beside that statement, and then click the Apply and OK buttons. Repeat for each file that will not open.

<u>Module Name</u>	<u>File Name</u>	<u>Comments</u>
Overview of MixW	MixWMain.chm	Required Module Must be in MixW Data Folder
Configuration and Set Up	MixWConfig.chm	Covers the most important MixW features
Operation	MixWOps.chm	Menu descriptions and operations that are common to all modes
Digital Modes	MixWModes.chm	Basic theory and operating specifics for each of MixW's modes

To use MixWHelp standalone, such as on a different computer, copy the modules you want onto the computer and create a shortcut, on the desktop, pointing to MixWMain.chm.

---

To download the MixWHelp modules see the Files section on the MixW reflector (see below).

MixW help is available as a .pdf file from the reflector.

To keep up to date on the status of MixW join the MixW reflector at:  
<http://groups.yahoo.com/group/MixW/>

---

# \*CONFIGURATION & SET UP

---

1. [Configuration](#) -- Software Settings
2. [Basic Set Up](#) -- PC/Tevr Interface
3. [PTT Circuit](#) -- Hardware Connection
4. [Configuring Macros](#) -- Operating Efficiently

## Configuration

---

In early versions of MixW Help from the menu bar was not always visible.

Mixw uses two different menu layouts. If Help is not available change your menus to look like this:



If the Help menu is not visible in the main Mixw menu bar, select:

**View | Menu and choose Layout 1.**

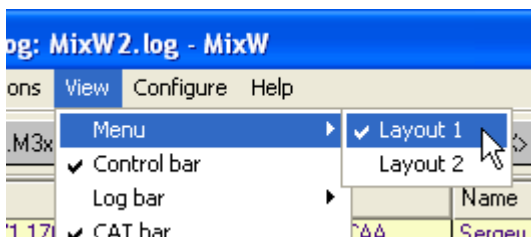

---

### Personal Data

Your first task is to tell MixW who you are, and where your QTH is. Click on Configure | Personal Data. This brings up the following dialogue box:

The screenshot shows a 'Personal data' dialog box with the following fields and values:

- Call: K6IX
- Name: Scott
- Log file: MixW2.log
- QTH: Ahwahnee, California, USA
- Lat: 37.37
- Long: -119.77
- Locator: DM07CI
- IOTA: (empty)
- Domain (state): California
- County: Bexar
- Use CWID:
- East:
- Slow:
- CWID: de K6IX k

Fill in your station information, as indicated. (Use ALL CAPS for your callsign).

**Note:** If your location is South of the Equator your Lat(itude) value will be negative.  
If your location is West of the Greenwich Meridian the Long(itude) value will be negative.

MixW will set a [default log file name of MixW2.log](#) . This log will be a semi-colon separated text data file located in the MixW data directory. From Version 2.2 onwards MixW now offers 4 different format options:

CSV - the default Semi-colon separated fields)

MDB - Microsoft Access file format.

MySQL - SQL database. Requires MySQL to be downloaded.

Web - External Web format. Requires suitable software to be installed.

If you want to be able to send a CW ID at the end of your transmissions, click the checkbox, choose the speed, and enter the text to send. The <CWID> command, inserted in your sign-off Macro, sends your CW ID string.

When finished configuring here click the OK button.

**Note:** You must at least enter your station call sign in order to transmit with MixW.

### MACRO Configuration

MixW has extensive Macro features for contesting as well as rag chewing. See [Configuring Macros](#) for instruction on configuring and operating with Macros.

### Fonts

Select Configure | Fonts >Font for TX/RX windows, Font for macro buttons, Font for the Log Bar or Font for Telnet Windows. This will bring up the font selection dialog box. Here you can select the font that will be used in your receive and transmit windows, for the macro buttons, the Log Bar or the Telnet windows.

There are separate Font selections available in the DX Cluster settings and Additional Rx window configuration.

### Text Colors

Select Configure | Text Colors. This will bring up the following dialog box:

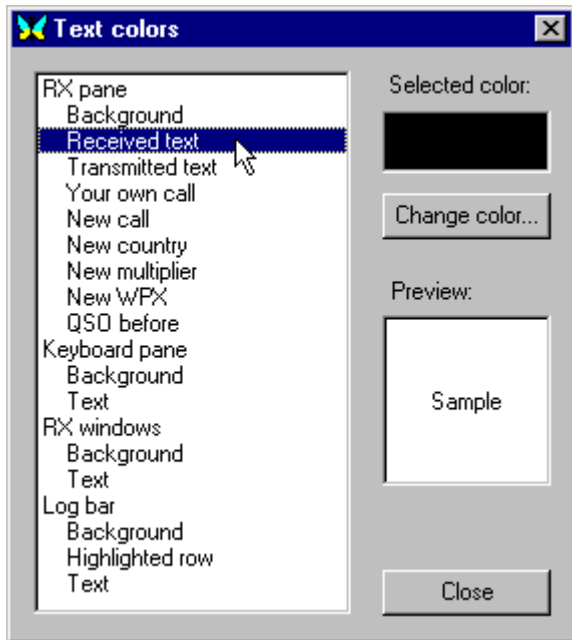

Here you can select the text colors for the various text types. This is a handy way to customize your text to easily recognize call signs, new call signs, new DX, customize contest mode colors such as new multiplier or QSO before, receive and transmit window background colors etc... The ability to customize your applications and operating preferences is an important feature of MixW.

A separate Color selection is available in the Additional Rx window configuration.

### **Configure your Transceiver CAT and PTT settings:**

If you are triggering TX/RX with a PTT circuit, and/or using CAT control, you will need to configure MixW to communicate with your transceiver. To do so Select: Configure | TRCVR CAT/PTT. This will display the following dialog box:



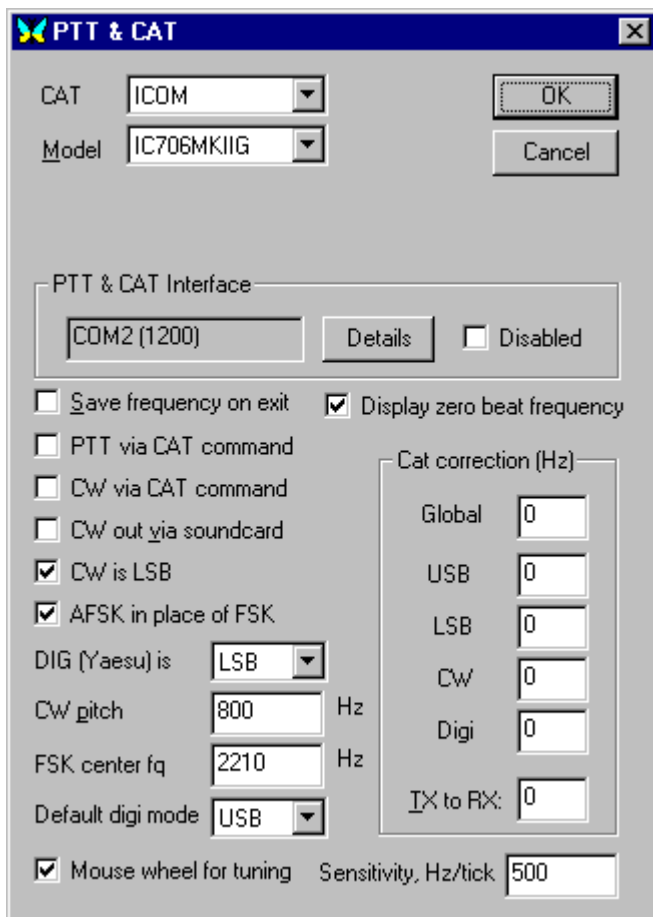

This box is for the PTT and/or CAT features. If you will not be using the CAT function, set TRCVR to "None" and click on "Details" to configure your PTT COM port options.

If you will be using CAT, select your transceiver make and model from the drop down menus.

**Note:** If you do not find your model continue to look carefully all the way through both lists. The lists are not in order. If your model is not listed, try a similar model of the same make.

**Display zero beat frequency:** If checked the CAT Bar will display the frequency of the transceiver. If not checked the CAT Bar will display the frequency of the current QSO (ie. Zero Beat Frequency + Audio Frequency).

If you are using a Yaesu transceiver and have elected to use a USB digital mode setting in the transceiver menu set **DIG (Yaesu) is USB**.

**Default digi mode:** This drop down box contains 5 selections. If you cannot find a selection that corresponds to your transceiver operational digital mode select none or either USB or LSB.

Default digi mode is the mode selected if you enter a mode that is defined as Default in the bands.ini file.

See [Cat Bar/Cat config and Bands.ini](#) to set the bands.ini and CAT configuration for best operation of your MixW/Transceiver combination.

Check the PTT via CAT command box, if applicable, and then click on "Details" to configure your CAT COM port options.

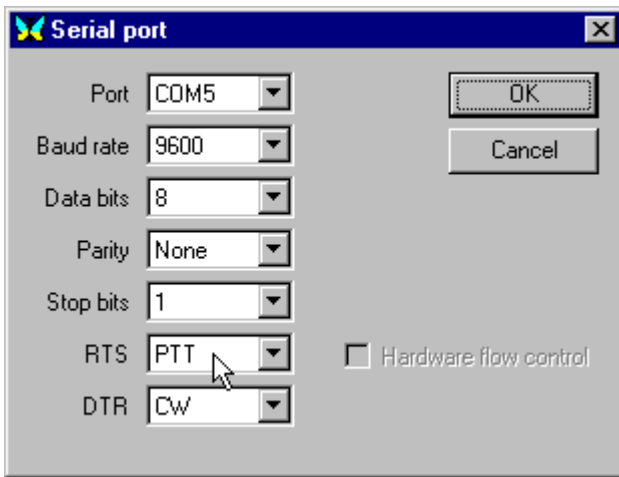

Select the COM port you will be using. If you are using this port for PTT only, then only the COM port number and the RTS/DTR settings apply. If you are using this port for CAT then set the port to match the requirements of your transceiver for CAT.

If you want to use one COM port for CAT and another for PTT, first configure the CAT/PTT port for CAT, then choose: Configure | Secondary PTT port | Port Settings to set the secondary COM port for PTT.

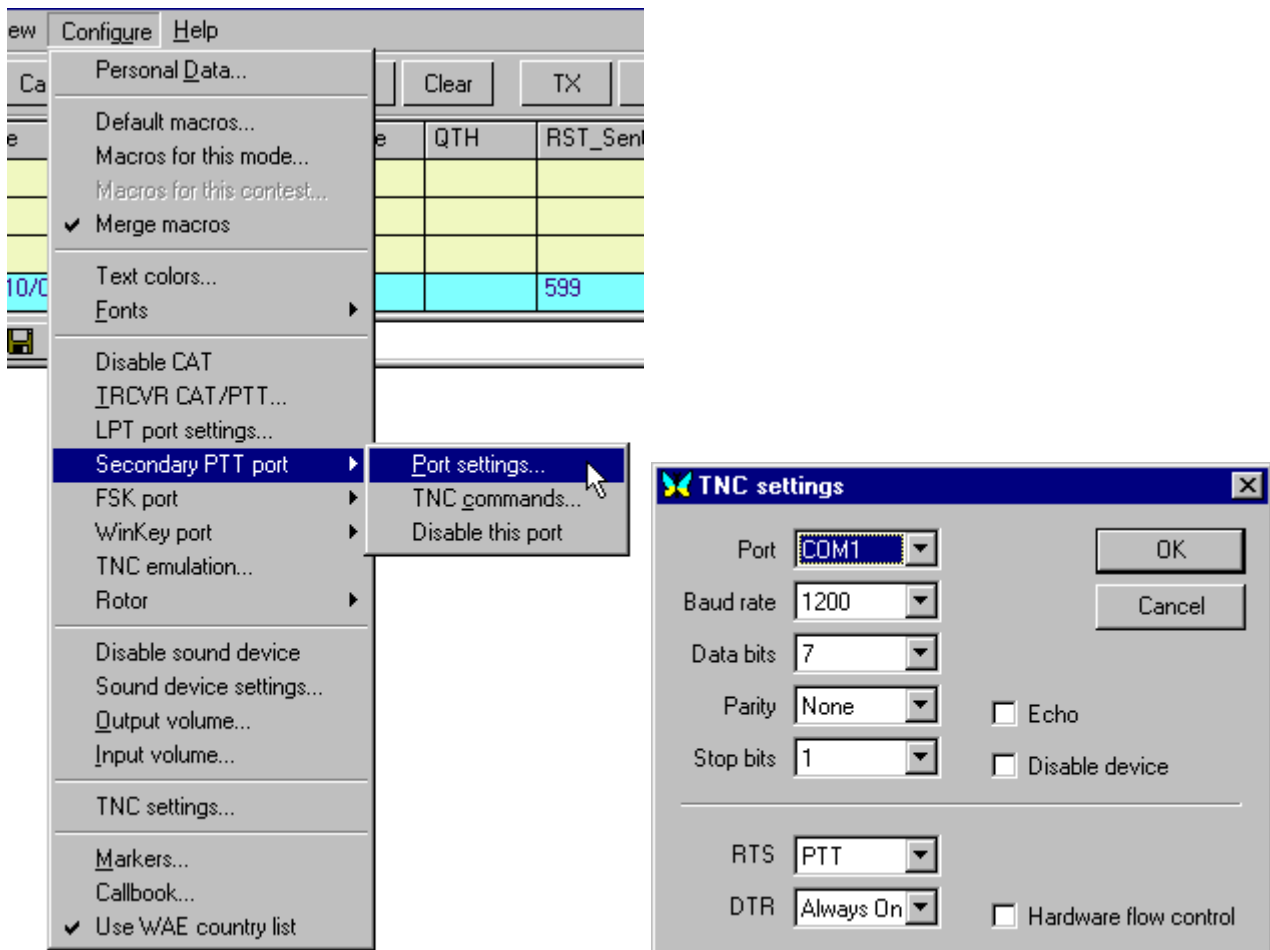

If you are triggering PTT by radio command (CAT) and do not need to key a separate PTT or CW circuit then you can click the Hardware flow control box in the CAT/PTT Serial Port dialog, and make sure your COM Port, Baud Rate, Data Bits, Parity, and Stop Bits match your transceiver's settings. RTS and DTR are not used.

**Note:** The transceiver must support "hardware flow control" if this box is checked. If it does not support it, you will encounter several problems. If this is the case, uncheck the "hardware flow control" box, and instead set the DTR and RTS to "always on". Make sure you have enabled the PTT via CAT in the previous dialog box.

The RTS and DTR pins of the selected COM port are where High/Low signals are delivered to key your PTT circuit, your CW circuit, or both. They can also be set to "always on" or "always off" to facilitate a combination of PTT keying via a PTT circuit in conjunction with using CAT for automatic rig QSY, frequency reporting, and other features.

RTS uses pin 4 of the DB-25 connectors, or pin 7 of the DB-9 connectors.

DTR uses pin 20 of the DB-25, or pin 4 of the DB-9.

**Configuring for LSB or USB operations:** The MixW options for RF, USB/LSB should be configured to reflect your mode of operation by selecting View | Spectrum | "Sound". "RF, USB", "RF, LSB" or "Auto". These must be set correctly in order for the frequencies in the log and spectrum/waterfall displays to represent your actual operating frequencies, and for MixW to automatically adjust the inversion settings based on your RF mode.

### **Inversion:**

**Note:** This feature works differently in MixW than most other SoundCard digital programs, so please read and understand the following information to avoid confusion while operating.

Modes that utilize the inversion feature are QPSK31, MFSK16, RTTY, AMTOR, Hellschreiber, THROB, SSTV, Olivia, Contestia, RTTYM and FAX. In MixW, "Inverted" means to invert the Mark and Space tones from the normal operating standards of the active mode. This feature can be used in cases where the station you are attempting to work is inverted.

To illustrate: When using a traditional hardware TNC, RTTY is almost always operated in the LSB mode, utilizing a 170 Hz shift between the MARK and SPACE tones, with the MARK tone being the higher in frequency. If MixW is set on "RF, LSB" it will set the Mark tone as the higher tone. However, if MixW is set on "RF, USB" then the Mark tone will be set to the lower tone. (You can **think of this as an automatic inversion** if you like). In other words, if MixW is configured correctly (it needs to know if you are using LSB or USB) then it will automatically adjust your Mark and Space tones for you. You would **only use the "Inverted" feature to operate inverted from the standard practice of that mode** of operation, regardless of whether you're using USB or LSB.

If you are configured to use the CAT features of MixW, the USB/LSB and frequency changes will all be done automatically for you by selecting View | Spectrum | Auto:

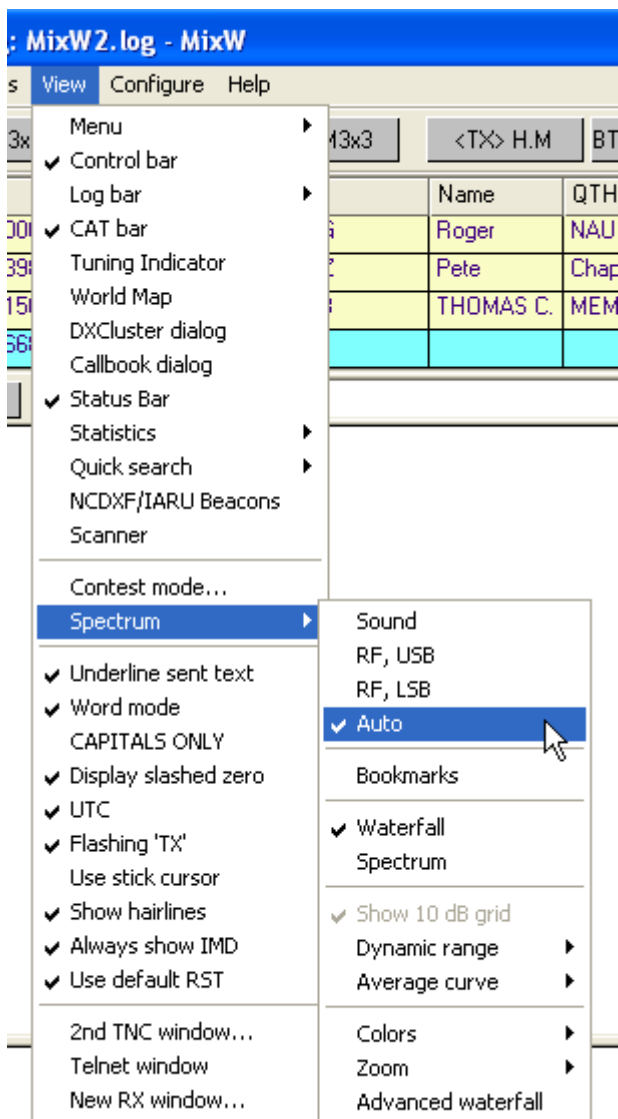

Now, MixW will automatically know if you are using USB or LSB, as well as your operating frequency by polling your transceiver via the CAT feature. Your MixW operating frequencies (in the spectrum display as well as the log and CAT bars) will also automatically represent the audio offset, which will be either plus or minus your transceiver's frequency, depending on whether you are operating LSB or USB.

If you are not using CAT to determine your mode and frequency, you can still set your "RF, USB" or "RF, LSB parameters manually from this menu. Your frequency will be accurately displayed as long as you manually set your frequency in MixW to match your transceiver's frequency and sideband. This can be done using Alt-F to bring up the CAT bar and entering the settings manually.

Selecting View | Spectrum | Sound will show the audio offset alone, without regard to the RF operating frequency.

**Note:** The audio frequency can also be displayed by placing the cursor above the spectrum display until you see the cursor turn into a hand and pressing the left mouse button.

### Rotor Selection and Control

This section pertains to PC controllable Rotors. Select Configure | Rotor | and then click on your Rotor brand.

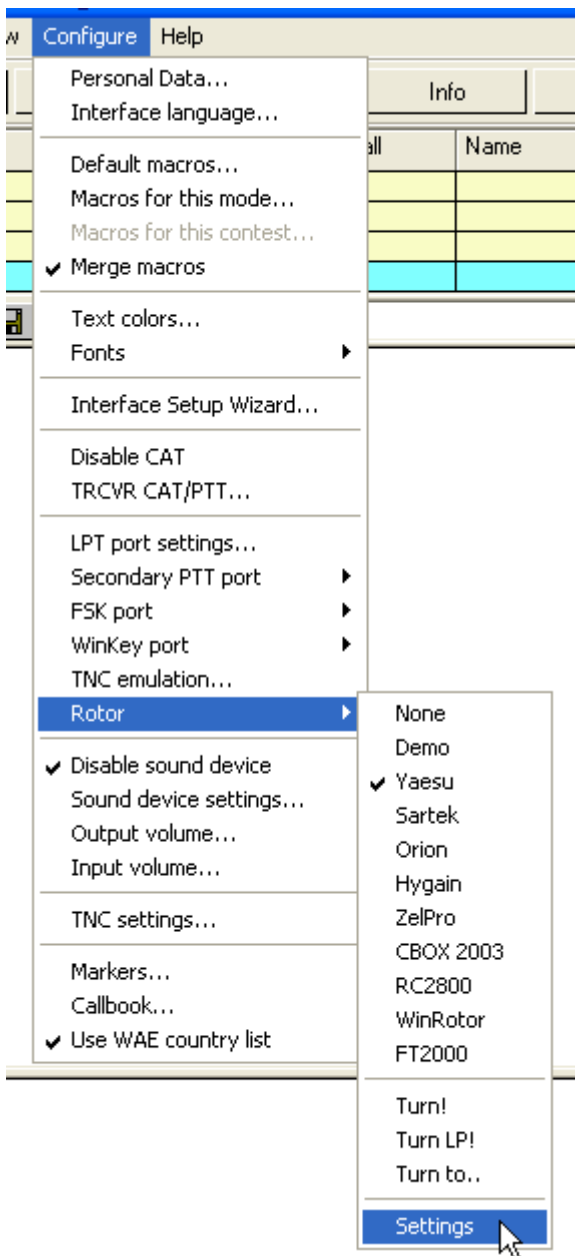

Next select Configure | Rotor | Settings. This brings up the following Port dialog:

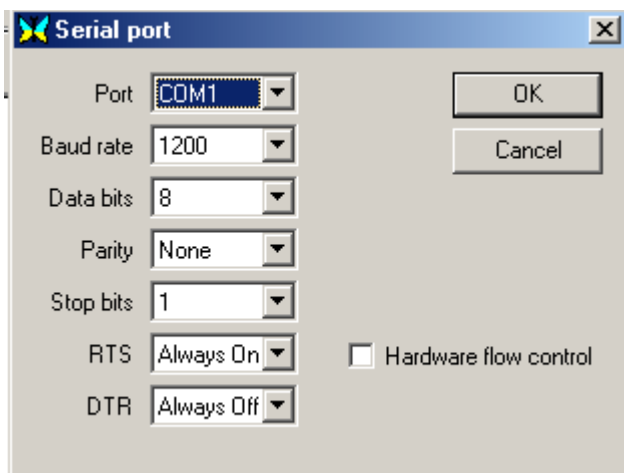

While this looks the same as the Port dialog for your CAT/PTT information it is for selecting your Rotor control information. Set these parameters by consulting the manual for your rotor.

When you click OK to close this dialog a box will pop up to allow you to input an Azimuth setting. Type it in and click OK. This can be changed later by selecting Configure | Rotor | Turn to... Your other options are Turn! (Turns the rotor toward the station in Call), and TurnLP (Turns the rotor toward the long path

direction of the station in call).

**Note:**

There are 5 Macros associated with Rotor Control. See the [Macros](#) section in the Appendix.

To use Rotor control successfully both the `cty.dat` and `pfx.dat` files are required. MixW will start without having these files present, although a warning is given.

The `cty.dat` file is regularly updated. See using [cty.dat](#) and [pfx.dat](#) in the Appendix section.

### Configure the WinKey Port

If you are going to make use of a WinKeyer device select Configure|WinKey port. The following dialog box is displayed.



The only value that can be changed is the Port number. Click OK when you have selected your Port number.

A file `Winkey.ini` is installed with the other data items. This file can be modified to your personal needs. See [WinKeyer](#) site for further information on modifying this file.

To use the WinKeyer there must be no ticks in any of the CAT CW configuration boxes

- Save frequency on exit
- PTT via CAT command
- CW via CAT command
- CW out via soundcard
- CW is LSB
- AFSK in place of FSK

and neither the CAT nor any of the Com Port configuration settings should have CW via DTR or CW via RTS selected.

### Configuring the Sound Device

Open the sound device settings dialog by selecting Configure | Sound device settings... If you have multiple sound devices in your system, you select which one you want MixW to use for TX and RX functions. You can also set the sample rate, sound history, spectrum speed, as well as select a DSP filter, which can help your copy in certain conditions.

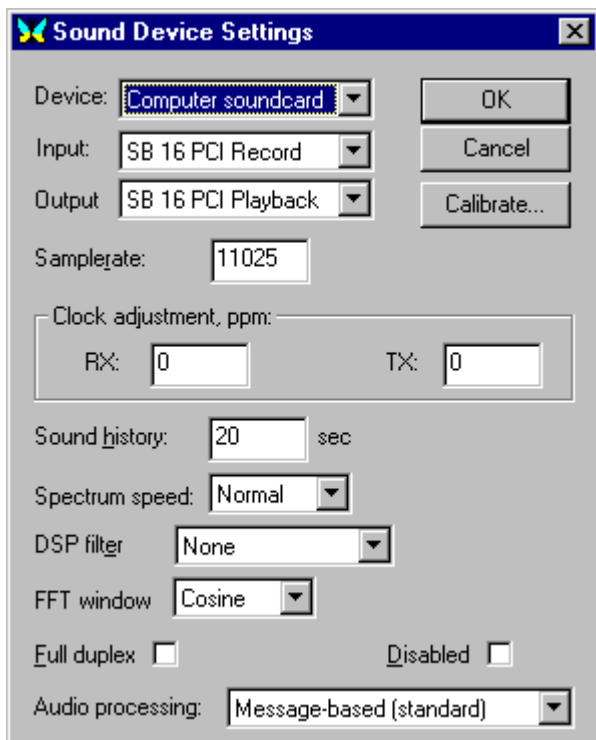

**Sample rate:** A value between 7000 Hz and 12000 Hz for a soundcard sample rate is displayed. MixW works best with the default sample rate of 11025 Hz, although other rates can be used to accommodate differences in soundcards. Generally, it is not necessary to modify the default value except in special circumstances.

**Calibrate:** The correct operation of many MixW modes depends on a properly [calibrated soundcard](#).

**Sound history:** This selection presents an input box for entering the number of seconds of previous reception to be stored in MixW to be played back by holding down the Shift key while clicking on a signal. The signal will be played back at an accelerated rate.

**Spectrum Speed:** This setting alters the speed of your waterfall or spectrum display. A faster display will make tuning in signals easier and faster, but it also requires a faster computer and soundcard.

**DSP filter:** For digital mode use any selection, other than None, will result in the loss of decoding of signals from the waterfall. These filters are not intended for digital modes use. If a filter is selected and MixW is put into transmit mode the filter will be reset to None.

**FFT window:** Square has best frequency resolution, Nuttall has the best sidelobe suppression and is the best for IMD measurements, and Cosine (default) is a reasonable compromise for usual daily operations.

### **Waterfall Audio Frequency Markers**

By selecting Configure | Markers... markers can be set in up to 5 audio frequency locations. This will place a thin red line running down the waterfall display at the desired location as follows:

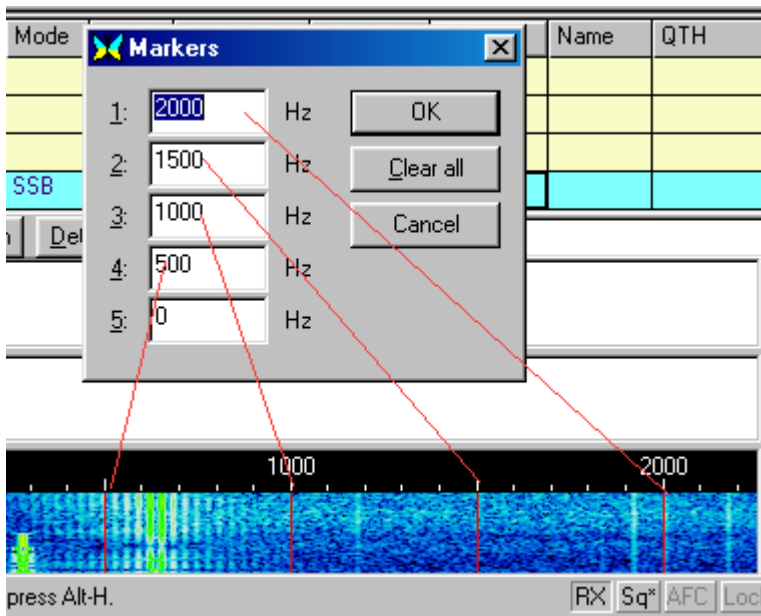

### Waterfall Known Frequency Markers

By placing known frequencies in the "KnownFqs.dat" file a grey marker can be placed on the waterfall at that frequency. In the example below a NCDXF/B marker at 14.100 mhz is shown. Open the file with a text processor to add your own frequencies. View | Spectrum | Bookmarks must be checked to make the markers visible. A temporary known frequency can be set at the current RX position by right clicking on the waterfall and selecting Mark Known Fq.

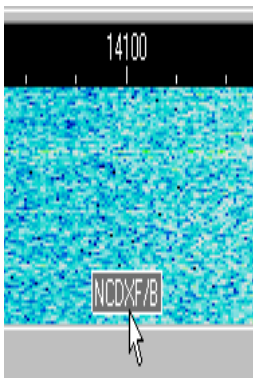

### Band Edge Markers

A small red circle with a white line through it (international "Do Not Enter" traffic sign ? ) is placed just below the lowest frequency for the band and just above the highest frequency for the band. The lowest and highest frequencies are taken from the [Bands.ini](#) file which you can modify using a text editor such as Notepad.

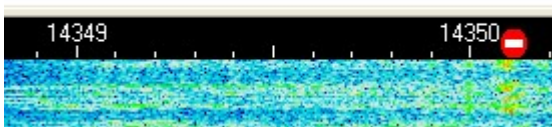
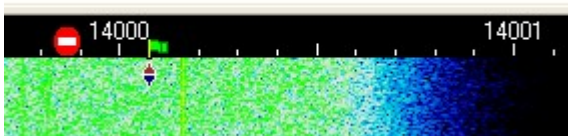

### Callbook...

MixW will automatically look up log entries in a callbook. Select Configure | Callbook... In the Callbook settings dialog select your Callbook type and provide the path to the callbook database.



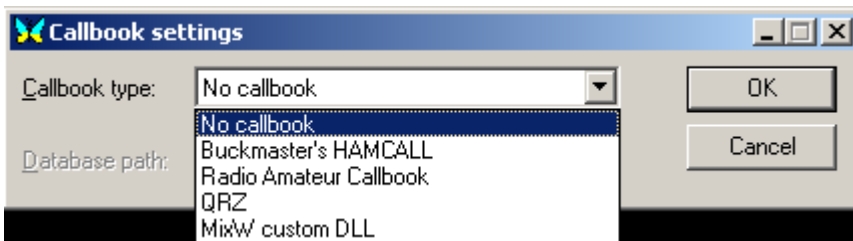

For example, if you have copied the QRZ database to your C: drive, you would enter "C:\callbk". If you are using the QRZ directly from the CD you would enter "D:\callbk\" if your CD was in drive D.

MixW offers the facility to install a third party dll enabling the user to access call data from a remote web site. One dll available permits [call lookup from QRZ.COM](#). You must have a valid username/password to use this DLL and to get detailed information an annual subscription is required for QRZ.COM.

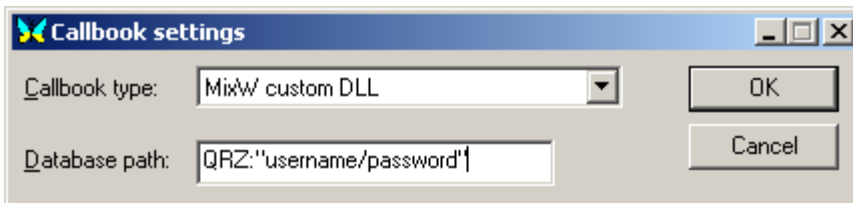

Select MixW custom DLL for the callbook type and enter QRZ:"username/password" in the Database path text box. The double quotes(") must be included in the input.

When the callbook set up has been entered select Options | Auto search in callbook. Now when you enter a call in the current QSO line of the log MixW will look up the call and display it as shown here.

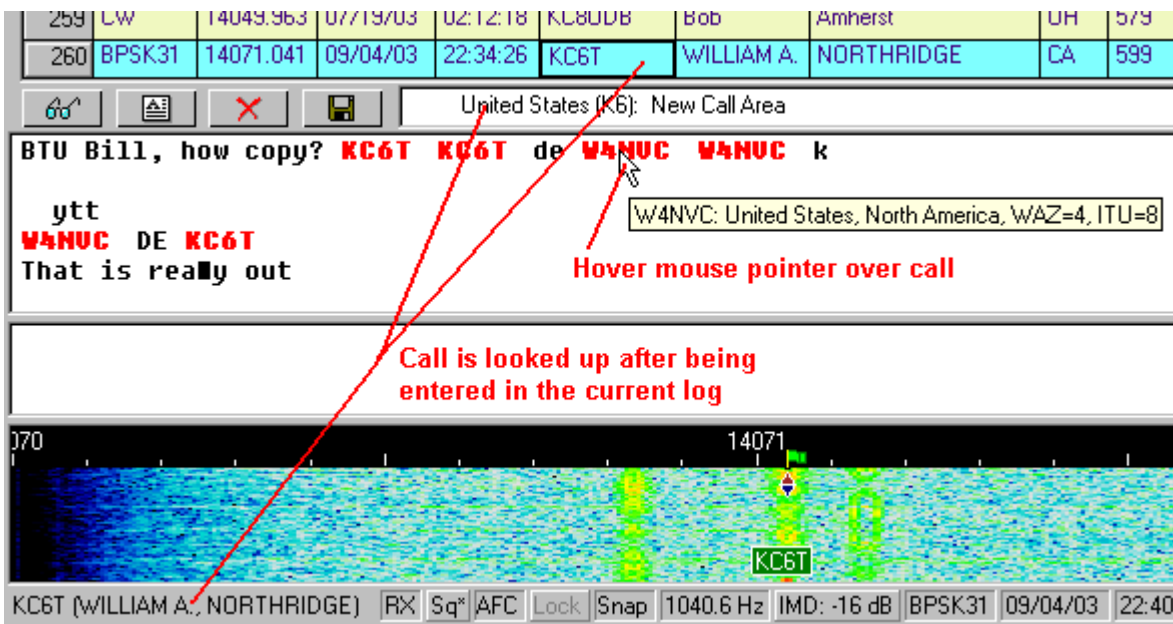

**NOTE:** The data shown when the mouse pointer is hovered over the call does NOT come from the callbook.

## Basic Set Up

**Interfacing your Transceiver to your PC:**

Interfacing your transceiver and PC to work with MixW can be handled many ways. A two-way audio path must be provided between the transceiver and the computer soundcard, and the transceiver needs to be switched between TX and RX. You can configure MixW to switch between TX and RX in four ways.

1. Operate a push-to-talk (PTT) switch via a voltage to the DTR or RTS pins of a com port, the same port can also be used for serial communication with the radio (CAT operation) if desired.
2. Use transmit and receive commands to the radio via the serial port through CAT, without using the PTT circuit (your radio must support PTT by CAT).
3. Use the VOX circuit in your radio to switch it into transmit when it hears the audio sent by the computer, and back to receive when the audio stops.
4. Operate the radio transmit/receive manually

Note: There are a number of commercially constructed interfaces available to enable CAT control and PTT operation of most modern transceivers. A number of these interfaces also contain separate built in sound cards. Also available are units that allow COM ports to be derived from PC USB ports.

A number of circuit diagrams are available on the internet to allow personal construction of an interface.

**Important Note:** Your microphone must be disconnected from the radio (or otherwise switched out of the circuit) to avoid inadvertently transmitting voice signals in the digital bands. When using VOX, Non-MixW computer sounds (such as the Windows start up chime) can also trigger the VOX circuit and key the transceiver.

It is extremely important to match your sound input and output levels. This is done with either the Windows Volume and Recording controls or if you have a sound device with physically accessible level controls, these controls. The windows Volume and Recording controls can be launched from within MixW by selecting Configure | Input volume, or Configure | Output Volume. Be sure your MixW software has been configured as described in [Configuration](#).

### Setting Audio RX Levels:

Set the input volume first by selecting Configure | Input Volume, which will bring up some version of the audio mixer recording control.

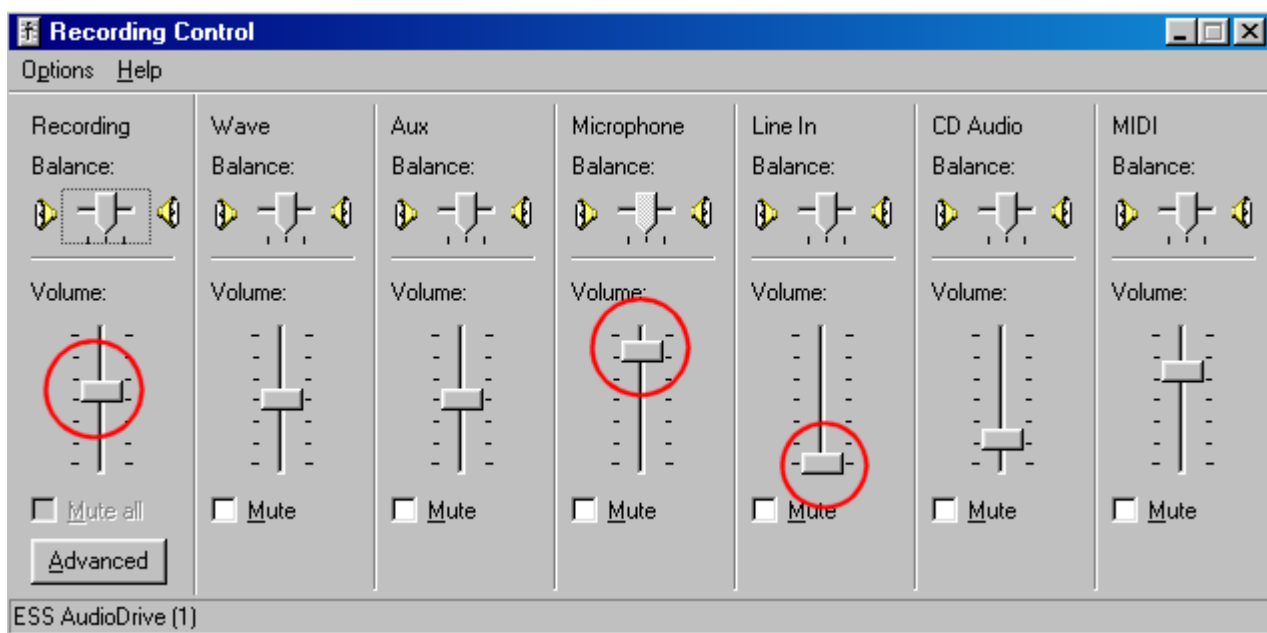

For these adjustments it is convenient to arrange your MixW window and your audio mixer control so

that you can easily see both windows and switch between the two. Set your transceiver's audio (listening) volume to a comfortable listening level.

Depending on your set up, you will be adjusting the Mic or Line-in controls. The best way to set these levels is to roughly tune in digital mode activity with your transceiver, and then click on the strongest signal in the waterfall display to direct MixW to that QSO. If MixW does not lock onto the signal right away you can then fine-tune it with your transceiver, or by clicking on the signal in the waterfall display again.

Adjust the input level on the Mic or line inputs until the background noise shows a dark to light blue color, and the actual signals (or strong noise) are a light green color. Strong signals on the tuning display will be yellow or orange. It's very important not to overdrive your soundcard inputs. Overdriving these inputs will severely degrade your copy, and give you inaccurate IMD readings. Adjusting for the minimum record levels, while still providing a good display is the best starting point. It may be necessary to attenuate the signal between the transceiver and sound card, especially if you're using the Mic input of your soundcard. This can be done with a simple voltage divider circuit.

If you don't see any receive activity on MixW's displays at all, make sure that your Mic or line-in control is not muted ("Mute" is a check box near the slider) and/or that the input you are using is selected. (These options will vary depending on your soundcard drivers). Also double-check all your connections. It's also possible you're overdriving your soundcard and will need to attenuate the input signal.

After these receive adjustments are optimized, go ahead and try to copy some QSOs to get a feel for the proper levels.

### Setting Audio TX Levels:

To transmit digital signals, you need to connect the sound card output often through an isolation transformer, or 100:1 attenuator) to the transmitter microphone, AFSK, or audio input.

With the interface connected, and your transceiver connected to a dummy load you can now set the audio output level of your PC soundcard to match your transceiver's input circuit.

**It is extremely important to match your sound output levels.** To set the output level bring up the Windows Volume control by selecting Configure | Output volume:

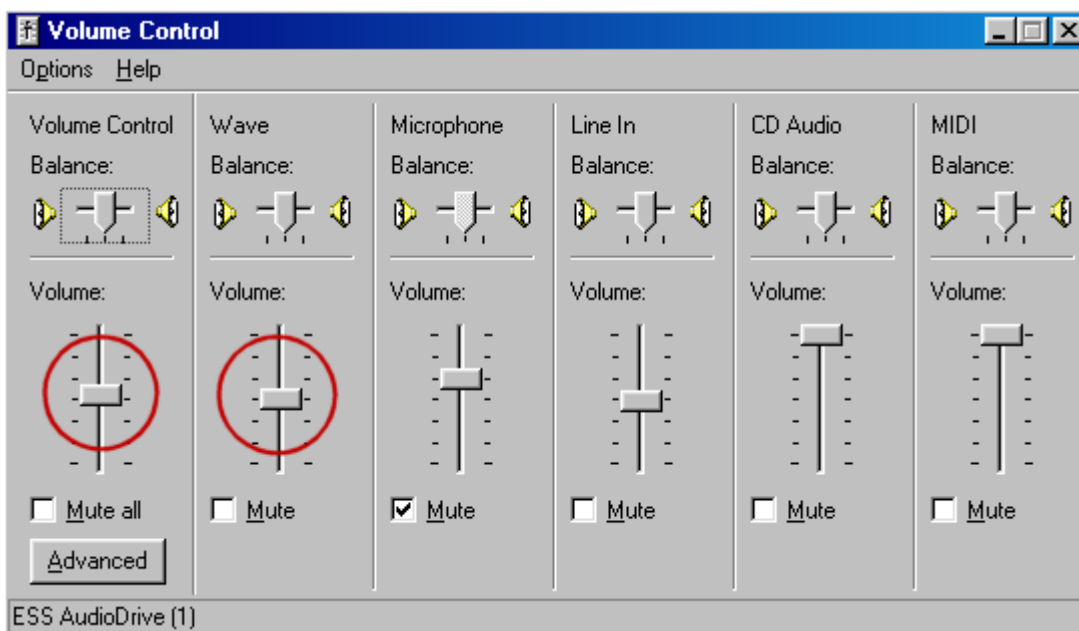

These audio output adjustments are best made with your transceiver connected to a **dummy load**. This eliminates QRM as well as wear and tear on your equipment. Set your transceiver MIC gain control (if

you are using mike input) slightly above its minimum setting and make sure your rig's VU meter (or indicator) is set to monitor "ALC". Your VOX threshold setting (if you're using VOX) should be adjusted as you normally have it for your other modes. Set the VOX delay to LONG to prevent the possibility of dropouts. VOX must be on if you plan to trigger your TX/RX function with it. If you're not using VOX or an optional PTT circuit you can do these tests by manually engaging transmit on the rig when you tell MixW to transmit.

**NOTE:** MixW will not enter the transmit mode until you have configured your personal data information.

It is best to have MixW active in one window and the Volume Control mixer in a second window. For now slide the Windows Volume Control to a minimum (all the way down), and the Wave slider at just slightly above the minimum setting.

First select the BPSK31 mode by selecting Mode | BPSK31. Put MixW into transmit by clicking the RX in the status bar. The "RX" turns to "TX", and MixW will transmit a BPSK31 idle signal. To toggle back to the receive mode click the "TX" box in the status bar. **Caution: Do not transmit for long periods while making these adjustments.** If you find that your adjustments take a while, let your rig rest in the receive mode for a while in between adjustment attempts.

**The adjustments.** Slowly raise the Volume control fader on the mixer while watching the ALC meter. As soon as you see a reading on the ALC meter, back the Volume control slider off until the ALC is at (or slightly below) zero. **It is VERY important that you have NO ALC reading.** Now check the reading on your power meter. It will probably be about 50% of your maximum power. Remember that most of the digital modes run a 100% (constant) key down (duty) cycle. Many rigs cannot sustain 100% power for very long. Depending on the mode you are using you may want to reduce the power output of your transmitter even further than the zero ALC reading.

If you are using VOX transmit switching and the VOX has not engaged by the time your Volume is set at mid way up the slider scale, then raise your rig's Mic gain slightly and try again. If VOX does not seem to kick in at low enough audio level, you may want to set the levels by manually setting the rig into transmit, then adjusting the sliders to optimize your audio signal (again you should just see your ALC indicator moving, and then back it off to zero), then reset your VOX circuit to trip at that level of input.

The optimal setting when using an interface which has no attenuation, will usually have your soundcard output (Volume and Wave Control settings) very low, and your Mic gain at a little lower than your norm for SSB operations. If you find that you are unable to control the audio using these controls in reasonable ranges, you very likely need to add attenuation between the soundcard output and the rig's Mic input. You can also try using the audio input of your accessory jack (if your rig is so equipped). This may avoid your Mic pre-amp circuit and be a better choice for signal matching.

Once you've optimized these settings make a note of the positions of your rig controls as well as the Windows Volume and Recording mixer positions.

A number of additional soundcards are available that can be added to the control PC internal sockets or connected via USB or FireWire ports. Using an additional card for digital operation means the PC internal soundcard does not need to be adjusted and a number of external soundcards have level controls available for ease of adjustment.

**Note:** The ALC reading may vary between different bands. If the ALC value changes (in particular if the ALC level has increased) as a new band is selected the soundcard output level must be adjusted to reduce the ALC reading to zero or below.

## Sound Card Calibration

Sound card calibration is essential for good operating practices and techniques in digital modes. In SSTV mode pictures may not be square and working in keyboard modes the QSO may wander up or down the

band with an uncalibrated sound card. This of course will happen if the station being worked has an incorrectly calibrated sound card anyway.

It is recommended with later soundcards to set the sample rate to 12000 (see [Sound Card Configuration](#))

To calibrate the sound card:

locate the program CheckSR.exe in the MixW program folder  
Double click on the CheckSR program to start it

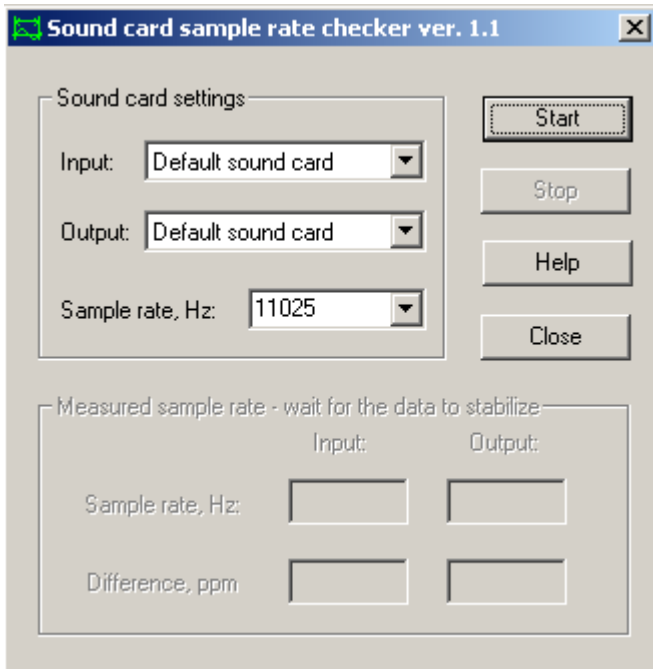

Select the correct sound card for both input and output

Change the sample rate to the value you have selected in the soundcard configuration

Click Start.

Let the program run until there is hardly any movement on the Difference PPM. This will take 30 minutes or more.

If you have the time leave it to run for an hour+ to get the most accurate readings.

Click on Stop and copy down the Difference PPM for the Input and Output.

Click on Close.

In MixW under Configure click on Sound Device Settings.

Copy the results from CheckSR into Clock adjustment ppm.

The Input reading goes into RX and Output to TX.

Click OK

Calibration is now complete.

It is advisable to check the sound card settings every 6 months.

## PTT Circuit

---

You have three basic options for PTT transmitter keying:

- Keying of the radio PTT line from a dedicated serial port,
- Direct command to PTT on/off Via the PC - Radio command interface (Certain radios only).

- Sharing the PC-Radio command serial port with the PTT circuit.

See [Configuration](#) to configure the MixW software for the PTT option you will be using.

**Keying of the radio PTT line:** For serial port keying, the PTT signal is accomplished by high/low voltages on pin 20 or 4 of a DB25 connector or pins 7 or 4 of a DB9 connector. (These are the DTR and RTS lines). To key the radio PTT line from DTR or RTS a transistor interface circuit is required. This simple circuit will do the trick:

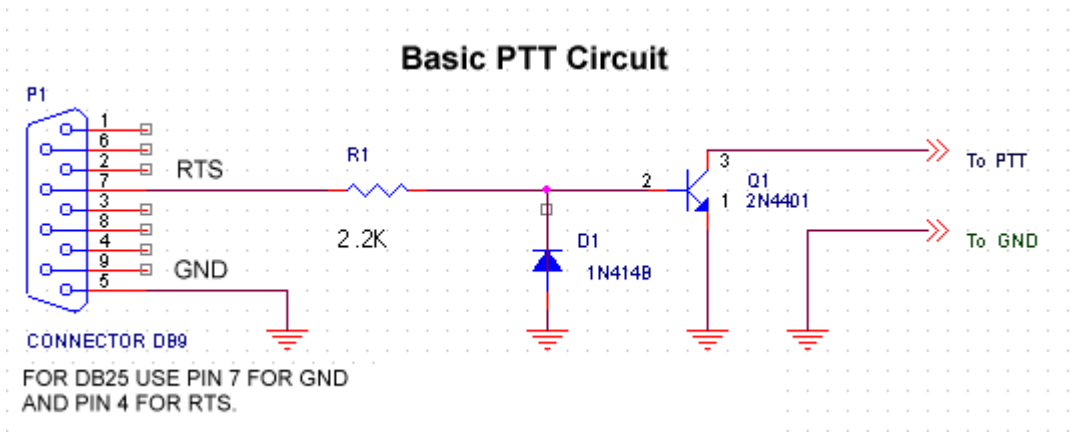

**Direct command to PTT on/off Via the PC - Radio command (CAT) interface:**

On some models of Kenwood, Yaesu, Icom, and TenTec radios, the built in capabilities of the radio serial interface can be used for PTT keying. If your radio supports PTT using the CAT interface no additional hardware connections are required.

**Sharing the PC-Radio command (CAT) serial port with the PTT circuit:**

Many transceivers do not use the RTS and/or the DTR lines for CAT. In this case you can use the same serial port for both CAT and a PTT circuit. This will require wiring a DB9 or DB25 connector such that the required pins are wired to each of the two (CAT and PTT) interfaces (normally a level converter for CAT and an electronic switching circuit for the PTT). Then in the PTT & CAT dialog you will UNCHECK "PTT via CAT command" and in the Serial Port dialog you will select either RTS or DTR for PTT and set the other parameters as needed for the CAT interface.

## Configuring Macros

---

For a complete list of Macro Commands see the [Appendices](#) Section of the MixW Help file.

**A WARNING**

If an attempt is made to use a text editor to edit the raw macro files it is possible Windows will 'corrupt' the file when it is written back. This will occur if a 'special' character (eg the temperature degree symbol) is included in a macro text. Some text editors write the data back with a sequence of characters identifying there are special characters in the file. This sequence of characters is invisible to a text editor but confusing to MixW and the macro set is now 'lost' to MixW although it is visible to File Explorer and can be edited by text editors.

Macro commands can be combined with each other, or combined with text, to control many functions of MixW, your CAT equipped transceiver, or your TNC. They can be used to reduce the need for repetitive typing.

MixW supports different Macro groups for each mode of operation, which can be automatically loaded when you switch modes (called "local" macros). You can also have different sets of Macros in files, which can be configured for specific types of operation. For instance, you can configure one set for contesting, and another for rag chewing. These can be custom configured, saved, and then reloaded from the Macro Configuration Window. To optimize Macros for contest operation see the [Contest Operation](#) topic in the Appendices Section of MixWHelp.

MixW's Macro system is extremely flexible and powerful, however it will take a little time to understand how to configure macros to best match your operating styles. Macros can be added or edited six different ways:

- By right clicking on the Macro button
- By selecting Configure | Default Macros
- By Selecting Configure | Macros for this mode...
- By Selecting Configure | Macros for this contest...
- By using the <EDITMACRO:macroname> macro
- By using the <macroname?> macro

**Note:** Macro commands must be typed in all capital letters. Text can be typed as upper or lower case. Lower case characters will automatically be converted to uppercase when transmitted for modes like RTTY and AMTOR, which only support upper case.

### **Simplified Macro editing instructions:**

When you first start MixW you will see the following set of buttons across the top of the screen. This is the Control Bar and can be switched on or off by the menu View|Control Bar.

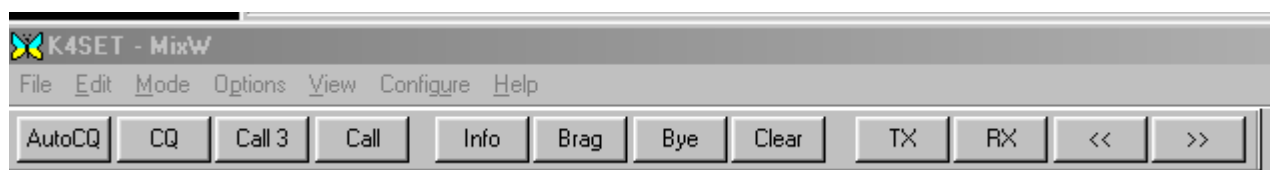

These buttons, which correspond to the F1 through F12 keys on the keyboard, are called **Macros** in MixW. If you click one of these buttons with the mouse or press the corresponding F key, it will cause a script of **Macro Commands** to be run. If you hold down the Ctrl key on the keyboard you will see a different set of macros which can be called with Ctrl-F1 through Ctrl-F12. Notice that some of the keys are blank, indicating that there is no script of Macro Commands assigned to that key. Twelve more macros can be created for Shift-F1 through Shift-F12, and twelve more for Shift-Ctrl-F1 through Shift-Ctrl-F12 providing a total of 48 macros for the F keys. The four different rows of Macro buttons can also be accessed by "rolling" the mouse wheel while the mouse is over the Macro buttons.

To view and/or change the F1 through F12 Macros, right (mouse) click the Macro (button). Right clicking the fourth macro, for example, will bring up the following dialog:

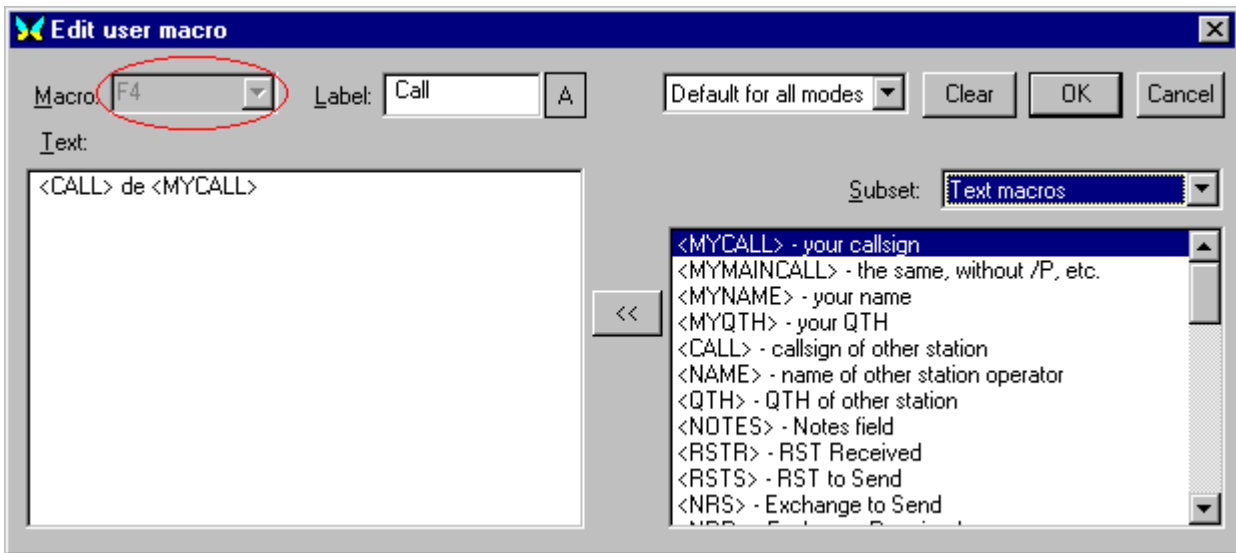

You can now edit this Macro's Label, as well as its text (script). You can also change the color of the button by selecting the small rectangle containing the "A" to the right of the Label box. All edit functions are available from this edit window with the exception of the Macro Key assignment (It is assumed you want this to be the key you right clicked on to bring up the window). There is a convenient list of Macro functions and short explanations in the box on the right. Highlight the desired function and click the double arrow to move it into the desired location in the Macro text box.

This simple example in Macro location F4 is named "Call", and will return the standard 1 X 1 call sequence.

Macros can be modified to increase the automation of MixW. For example, the Call Macro above can automatically toggle MixW between transmit and receive modes by placing <TX> as the first command and placing <RX> as the last command, so Call would read, <TX><CALL> de <MYCALL> k<RX>. In this example, pressing F4 would cause MixW to go into transmit mode, send the other station's call once, followed by "de", send your call once, followed by "k" and then automatically return to the receive mode.

The fourth item in the Edit User Macro dialog is a pull down text box which reads "Default for all modes" and indicates that the label and script that you enter here will become part of your Default Macros. Later you will find out about other sets of macros such as contest macros and mode specific macros.

There are several other types of macros which are not called by the F1 through F12 keys, and therefore cannot be edited using the right click method. You can call up a different Edit Window by clicking on Configure | Default macros, which will bring up the following dialog box:

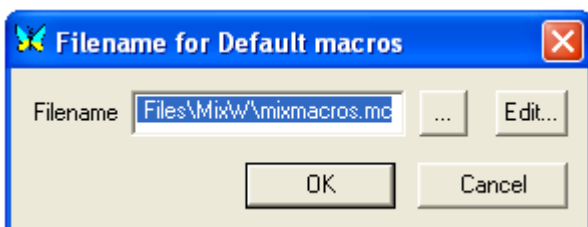

Click Edit to see the entire set of Default Macros. You should get the following screen.



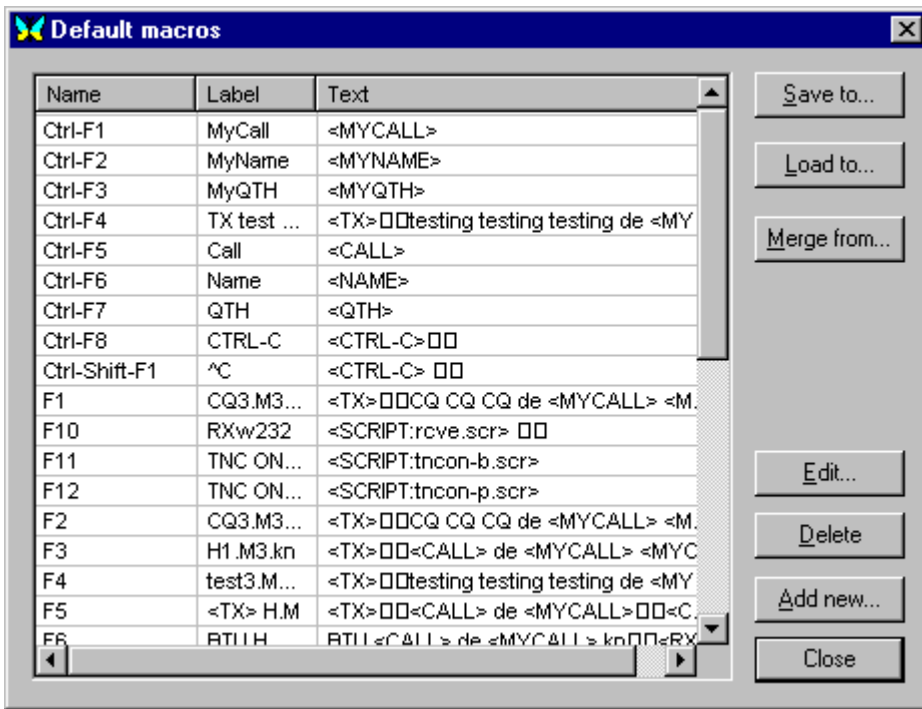

Double Clicking any of the Macro lines in this Window will bring up the Macro edit window. Notice that this edit window allows you to change the macro to a different F key or even to events such as On Start, On End, etc.

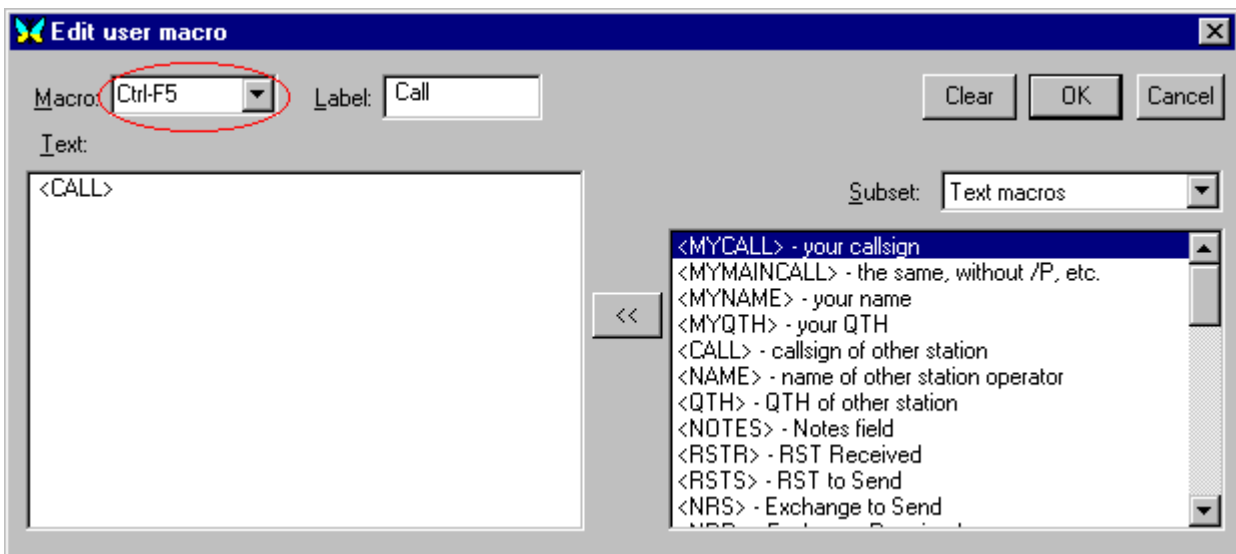

You can also add or delete macros from your Default Macro list as well as Load and Save this list to a file for later recall. This gives you unlimited use of Macros for every type of operation. Each group has a potential for 48 separate Macros assigned to specific F-keys and buttons, and there are several event macros available under "other Macros" as well. To see the "grey key" and event macro's look at the very bottom of the pull down Macro list box.

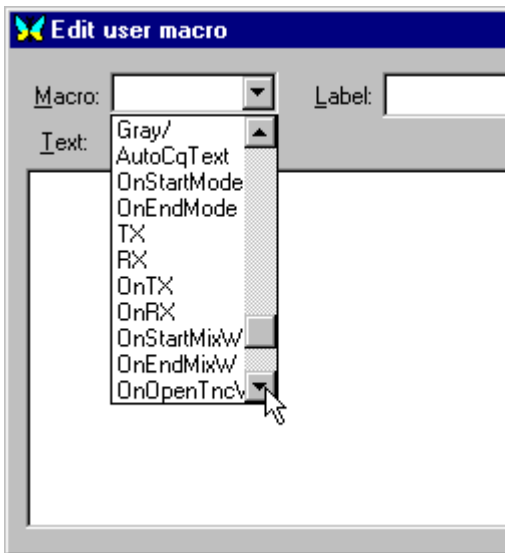

The Grey Key and Event macros will appear in the edit window as shown here:



An individual macro can be edited by using either the macro:

<EDITMACRO:macroname>

This will bring up the Edit user macro window.

or

<macroname?>

This will bring up a small text input box.

eg <OnEndMixW?>

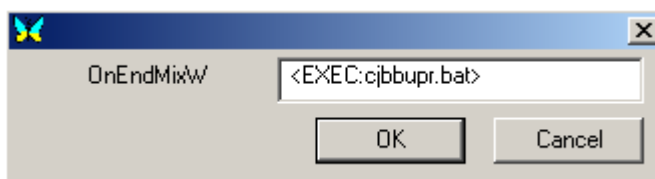

Input or change the text as required.

Using this method of creating or changing a macro has limitations. It is not possible to create extra lines using the Enter key for the macro being changed and if it is being created only one typed line is possible. However by use of <CRLF> multiple transmitted lines can be created.

When the edit text box is exited the macro will be executed.

Use <macroname> to execute the macro if it is being created/changed as an event macro

An example in the macro list is <WX?>

All of the things that we have talked about here which can be done with your MixW Default Macros can also be done with separate Macros for the different digital modes. This makes the use of application

specific Macros almost limitless. The section below is written by one of the programmers of MixW to explain some of the more complex uses of macros.

### **MixW 2 Macros explained by Denis Nechitailov, UU9JDR (with minor editing by K4SET)**

MixW 2 is supplied with a default set of macros. These macros are loaded from the "MixMacros.ini" file, which is located in your MixW directory, when MixW 2 is launched. This is the Default set of Macros used for all modes, meaning they are used regardless of which mode you are operating, unless you have configured specific mode macros that replace them.

You can choose another file to be your default macro file by selecting Configure | Default macros, which will bring up the complete list of default macros. Here you can add, delete, or edit each macro. You can also save this macro list to another file, or you can load a different list from a different file, which will then become your default macros. If you right-click on a macro in the control bar you can easily edit just the single corresponding macro, without having a big full list. Each macro has a label which appears on the corresponding button in the Control Bar, and a text which is placed in the TX window when you select that macro.

There are two general ways to use macros. The simple way uses a single set of macros at any given time. This set (or file) can be changed as outlined above, or it can also be changed on-the-fly using a macro. This is done by using the <MACRO:filename> macro. For example, you might like to configure another set of macros for a different language. For instance, your F5 key macro (using the default MixMacros.ini for the English language), might be the following:

Macro: F5

Label: Name

Text: My name is Eugene.

While in the Spanish version (MixMacrosSpanish.mc), your F5 key may look like this:

Macro: F5

Label: Nombre

Text: Mi nombre es Eugenio.

And so on.

We can configure MixW to quickly change between the English and Spanish macro sets by configuring a macro to change which macro file is active. This is achieved by doing the following: While using the English MixMacros.ini, at any unused key location (e.g. Ctrl-Shift-F1, for instance), place the macro:

Macro: Ctrl-Shift-F1

Label: Spanish

Text: <MACROS:MixMacrosSpanish.mc>

And in Spanish set (e.g. MixMacrosSpanish.mc),

Macro: Ctrl-Shift-F1

Label: English

Text: <MACROS:MixMacros.ini>

Now if you press Ctrl-Shift-F1 when you are using the English set, the Spanish set will be loaded (and vice versa).

Of course, this single default set of macros is not right for ALL the modes you operate, or for ALL situations. Sometimes, even switching macros by using the <MACROS:filename> macro does not solve the problem. So, in addition to using the simple macro mode (single set of macros) MixW 2 is capable of using a secondary system (called the local system), which can integrate mode or contest specific macros into your default macros. This can also be used to integrate macros specifically configured for hardware TNCs.

Why does one need to use local macros? For example, you would not want to have a macro with the text RYRYRYRYRYRYRYRY on the screen in SSB mode, even though this might be very helpful in the RTTY mode. You would also not want to have your recorded voice calling "CQ CQ etc.." in the PSK31 mode, while this could be helpful in the SSB or FM modes.



Macro dialog for the F2 key while in the RTTY mode (it now indicates "For this mode"), and clear the macro with the Clear button. Press OK and now F2 macro with RYRYRYRY is deleted from RTTY set.

### <OnStartMode> & <OnEndMode>

These macros are executed when you start or end a mode. They should be included in the separate Macros for this mode macro files.

For example, if you have a separate set of macros for SSB, you can define OnStartMode to turn on a Notch filter, and OnEndMode to turn it off. Now if you switch to SSB, the filter will be automatically turned on.

**TNC Macros:** When using TNC, the TNC's own file (it's name is entered into TNC Modes dialog from Mode | TNC modes settings menu) is used as a local macro file. Merge Macros can also be used if you want to merge TNC's macros with the default macros.

**Using macros with TNCs:** TNC operations in MixW 2 are based on two general principles:

1. TNC works in terminal mode (not host mode).
2. TNC state (mode, baudrate, TX/RX state, etc.) is controlled by using macros.

Usually you will have different sets of macros for different modes on the same TNC, and there are several steps that should be done for each set. First, you must define the macros to initialize the TNC and place it into the mode you want to operate (and de-initialize it at the end of mode). These two macros are used for this purpose:

OnStartMode  
OnEndMode

For example, to operate PACTOR using a KAM+ TNC, you may define them like this:

Macro: OnStartMode  
Label: Start (or whatever you choose)  
Text: <HIDETEXT><AUDIOFQ:2200>  
<SHIFT:200> <CTRL-C>X  
PACTOR  
<SHOWTEXT>

Macro: OnEndMode  
Label: End (label does not matter)  
Text:  
<HIDETEXT><CTRL-C>X  
<SHOWTEXT>

The first macro sets the center audio frequency and shift to draw the cursor at Waterfall/Spectrum window, then it sends "Ctrl-C" and "X" characters to TNC (to make sure it's placed into command mode), and then sends "PACTOR" command to place TNC into PACTOR mode. The second macro just places TNC into command mode. After defining OnStartMode and OnEndMode macros, re-define the TX and RX macros that are used to make the TNC transmit or receive. For PACTOR using the KAM+, they may look like this:

Macro: TX  
Label: tx (label does not matter)  
Text: <HIDETEXT><CTRL-C>T<SHOWTEXT>

Macro: RX  
Label: rx (label does not matter)  
Text: <HIDETEXT><CTRL-C>E<SHOWTEXT>

The first macro sends "Ctrl-C" and "T" characters (to transmit), and the second one sends "Ctrl-C" and

"R" to receive. And now if the <TX> or <RX> macros are used in any other macro, like F2 with "<TX>CQ CQ CQ...<RX>" text, then by pressing F2, the TNC will transmit "CQ CQ CQ..." and then go back to receive.

Other macros to connect, disconnect, etc. can also be defined using these methods.

**Contest macros:** You might like to have another set of macros (with short "CQ CQ TEST" serial numbers etc..) for contests. At the Contest Settings dialog (choose a contest from View | Contest mode | then highlight the contest and select the Edit button) then enter a name of the Macro file you want to use for this contest (and also check the Merge macros check-box).

Now, a combination of 3 sets of macros is used: macros for the specific mode, macros for the specific contest, and your default macros. Contest macros are only active when View - Contest mode - On menu is checked.

**Configuring Additional Macro Keys:** There are several keys which can be used for containing macros as well as the function keys, but they are not shown on the control bar, so these keys can only be edited through the full list (either the default list, the macros for this mode list, the TNC macros list, or the contest macros list).

At the Edit User Macro dialog, select (or enter) the hot key name in the Macro field. The additional keys supported now:

Ins

Gray+

Gray-

Gray\*

Gray/

OnAppCommandxx (MultiMedia Keys)

Please note that these names are case-sensitive.

To identify which multimedia key has been pressed to link to the appropriate OnAppCommand macro definition carry out the following steps:

With MixW loaded press the multimedia key.

The following message is displayed in the left side of the Status Bar

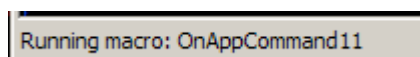

where the one or 2 digit number is used to identify the key. The numbers do not necessarily logically relate to the physical position of the keys on the keyboard.

Use the macro editing facilities to create the appropriate macro.

**Calling a macro from a macro:** It's also possible to call a macro from another macro. For example, if you have the following configured in the F2 key macro:

<TX>

CQ CQ CQ de <MYCALL> <MYCALL> <MYCALL>

You might like to use this same text for your Auto CQ. To do this, just place <F2> in the Auto CQ, instead of the Auto CQ text. Now AutoCQ will play the F2 text. You cannot call a macro from itself, however, if you try you will be warned about this when you try to run it. Moreover, **you may call a macro anything you want.**

For example, you can define a macro like this:

Macro: POWER

Label: (Anything you choose, it will not appear anywhere).

Text: 40

(This will not be shown on the Control Bar because it is not assigned to a specific key)

Now, this is used with the other macro as follows:

Macro: F6

Label: Brag

Text: <CR>The power is <POWER> <POWER> watts.<CR>

This uses the value that is entered into the POWER macro, and inserts it into the text for the brag macro.

To change the power macro on-the-fly, choose an unused key (e.g. Ctrl-Shift-F2) and fill it with <EDITMACRO:name> like this:

Macro: Ctrl-Shift-F2

Label: myPWR

Text: <EDITMACRO:POWER>

Then if you press Ctrl-Shift-F2, it will bring a dialog box with the value 40 in it. Replace the 40 with 20 (for instance) and press OK. Now your F6 key will yield the following:

power is 20 watts

### **Favorite Macros from the MixW beta test team, and others who have written in:**

#### **From Richard "Griff" Griffin, NB6Z**

"SK"

<CALL> de <MYCALL> SK at <TIME><CWID><SAVEQSO><RXANDCLEAR>

"BTU"

BTU <NAME>... <CALL> DE <MYCALL> K <RXANDCLEAR>

"CALL"

<TX><CALL> <CALL> <CALL> de <MYCALL> <MYCALL> <MYCALL> K  
<RXANDCLEAR>

"RST"

Thanks for report from <QTH>; you are <RSTS> <RSTS> here in  
<MYQTH>.

#### **From Nick Fedoseev, UT2UZ**

Use <LOCKTX> in CQ macros:

<LOCKTX><TX>CQ CQ CQ de <MYCALL> <MYCALL>  
<RX>

Use <UNLOCKTX> in Search/Pounce macros:

<UNLOCKTX><TX><CALL> <CALL> de <MYCALL> <MYCALL> <MYCALL> pse k <RX>

While calling DX in pileups I need to send my call several times (from one to five times). I use following macro:

<MYCALL> <TX><RXE>

If I press according button four times, MixW transmits

"UT2UZ UT2UZ UT2UZ UT2UZ " and switches to RX.

#### **From Dick Thompson, WB0DUL**

Many times, we all type something like "Well Scott, the temp here is 60 degrees F and is supposed to stay that way for..." and so on.

I programmed my F12 key to display °F when I hit it. So When I type in the number 60 (or whatever it may be, it looks like this:

Well, Scott, the temp here today is 60°F and....

To create the "°" character, choose an empty macro. Put the cursor in the text box. Then, while holding down the Alt key, hit 0186 on the "keypad". The ° will appear. Just type the F (or C for centigrade) after it, name the Macro Temp and save it. Just hit that key (in my case the F-12 key) when you want to insert

°F or °C after a temperature.

### Use of <LANG\_>

This macro modifier makes it possible to change the contents of an associated macro to the language of the current QSO callsign.

It makes use of the lang.ini file delivered as part of the Mixw installation.

The content of lang.ini after installation is:

```
[MASK]
U*=RUS
R*=RUS
F*=FRA
I*=ITA
```

```
[DXCC]
DL=GER
EA=SPA
F=FRA
JA=JAP
```

As it stands this lang.ini file is assumed to be for an English speaking installation.

The MASK section defines calls where a complete initial prefix letter assigns the whole of that prefix group a language key. In the settings any call that starts with U or R is assumed to be Russian Language, F is French and I Italian. The DXCC section defines individual countries to a language key. France is included in both sections because as well as F prefix France can also have other letters as the first letter of a prefix (eg TM).

An example of the use of <LANG\_>:

The end of a QSO is:

```
73 <CALL> de <MYCALL> bye SK<SENDEQSLNP><SAVEQSO><RXANDCLEAR>
```

This could be changed to:

```
73 <CALL> de <MYCALL> <LANG_BYE> SK<SENDEQSLNP><SAVEQSO><RXANDCLEAR>
```

A number of macros are created using edit macros menu:

```
Name:BYE
Label: doesn't matter
Text:bye
```

```
Name:FRA_BYE
Label: doesn't matter
Text:Au Revoir
```

```
Name:RUS_BYE
Label: doesn't matter
Text:Doswidania
```

```
Name:GER_BYE
```



Label: doesn't matter  
Text:Auf Wiedersehen

Name:ITA\_BYE  
Label: doesn't matter  
Text:Ciao

When the <LANG\_BYE> macro is actioned it will substitute the LANG with the prefix language key and then insert the text in the transmit window. If there is no prefix language entry in lang.ini the default macro BYE is used instead.

It is possible to associate multiple countries to one language. An entry in the DXCC section OE=GER would associate Austria with the German language and a Spanish entry could be used to link a number of countries.

### **Waiting or slowing macro execution**

There are a number of ways of slowing down execution, to overcome timing problems.

Executing the sequence <FQ:29600><MODE:FM> does not reliably execute on some transceivers but <FQ:29600><CATWAIT:300><MODE:FM> overcomes the problem.

To completely halt a macro sequence for an indeterminate period:

.....<ALERT:Macro pauses>Text <macro> will halt the sequence at the <ALERT> macro until the OK button in the message box is actioned.

CATWAIT only delays CAT command activity and the ALERT macro needs attention. To delay a macro sequence for a fixed period the Mixw Script command sleep must be used.

To delay a sequence for 5 seconds to allow an asynchronous action to take place like switching off the log display at Mixw start up, to overcome a problem of window sizes being incorrect:

```
<ASSCRIPT>sleep 5  
runmacro "HIDE:LOGBAR"  
close
```

This sequence is inserted as the last 3 lines of the <OnStartMixw> macro.

The <ASSCRIPT> macro tells Mixw to action all the following data using the Script interpreter not the Macro interpreter so after the <ASSCRIPT> is actioned no further Mixw macro format commands can be included. However Mixw Script language allows individual macros to be executed by runmacro "MACRONAME". The Script commands are case sensitive, as are the Macro commands.

When the ASSCRIPT macro is executed a small window pops up. The close command clears it.

If a sequence of macro commands is to be part delayed then the following is the way to do it:

```
<TX>73 <CALL> de <MYCALL>sk <RX>  
<ASSCRIPT>sleep 7  
runmacro "Ctrl-F5"  
close
```

Macro Ctrl-F5 contains:

```
<TX>qrz qrz de <MYCALL> <MYCALL> pse k<RXANDCLEAR>
```

If the <RX> is left out the transmitter will be left on and idling for 7 seconds.

The parameter to sleep is in seconds.

### **One Macro key to switch BPSK/QPSK modes**

**Note** This only works on the latest MixW releases.

To use a single macro key to switch between B/QPSK31,63 and 125 carry out the following steps:

- 1) Identify the macro key to be used.
- 2) Select BPSK31 mode
- 3) Right click the macro key you have identified in step 1
- 4) Select a suitable Label (To PSK63?)
- 5) Set Macro for this mode
- 6) Put <MODE:BPSK63> in the text box and save the macro.
- 7) Click the macro button you have just changed.
- 8) Repeat steps 3-7 for Mode BPSK63 then Mode 125, to bring back to BPSK31 mode.
- 9) Selecting the macro button you have identified should cycle between the 3 modes.

Select Mode QPSK31 and repeat steps 3 to 9 for the three QPSK modes.

These actions will set up 6 mode specific macro files. One for each of the modes. If you have other mode specific macros for these modes they need to be included for each of the modes.

**REMEMBER BACK UP ALL YOUR MACRO FILES.**

## **\*OPERATION**

---

1. **Starting Mixw** - how to start Mixw
2. **General Operation** - for all modes
3. **File Menu Items** - short descriptions
4. **Options Menu Items** - short descriptions
5. **View Menu Items** - short descriptions
6. **Using the Status Bar** - essential how-to
7. **Logging and QSLing** - essential how-to
8. **Saving and Archiving** - files changed for Mixw running

## **Starting MixW**

---

This section covers the initial start of a Mixw session in windows and what command line parameters are available. The history of some parameters is unknown but when a version number is known that introduces a specific parameter this has been recorded.

### **Starting Mixw**

There are a number of ways to start Mixw:

- Clicking on a Mixw Icon on the desktop (this is likely to be the most popular method)
- Starting Mixw via a batch file
- Using the Start Menu Run facility
- Typing a Mixw command line in an MSDos window
- Using Windows/File Explorer to select the executable and click on it.

If you use the Windows/File Explorer method command line parameters are not available. Mixw will start using the settings in Mixw2.ini.

For the other methods a command line is used to start Mixw. It has the form:

```
{Path to Mixw executable}\mixw2.exe for V2  
{Path to Mixw executable}\mixw3.exe for V3
```

If you use the Start Menu Run facility or start Mixw using an MSDos window the command line has to be entered each time.

For a batch file, an edit of the file is needed to find the Mixw start line.

To find the command line in a desktop icon right click on the icon and select properties. In the Properties window select the Shortcut tab and on the line Target: is a text line with the mixw startup command line.

If no parameters are specified on the command line Mixw will start using the configuration in the Mixw2.ini file.

### Parameters Available

Parameter	Description
/1	Starts Mixw with 1 Spectrum/Waterfall display. This parameter results in a change in the Mixw2.ini file. Possibly introduced in V2.16 but certainly works in V2.18 and later.
/2	Starts Mixw with 2 Spectrum/Waterfall displays. This parameter results in a change in the Mixw2.ini file. Possibly introduced in V2.16 but certainly works in V2.18 and later.
/setup	Mixw starts and displays the Soundcard configuration box. This parameter must be specified each time. Works in V2.18 and later.
NODDE	Disable DDE function.
NOOLE	Disable OLE function.
NONIC	Disable TCP/IP over AX.25
NOREP	Disable RigExpert Plus automatic detection.
MENU1	Start Mixw with the alternate menu layout (layout 2). This parameter results in a change to the mixw2.ini file. This parameter works in V2.19 and later. To revert to menu layout 1 use the View->Menu and tick Layout1.
NOAUTOREG	Disable automatic registration of Mixw at start up. Available in V3
DDE:xxx	Set DDE server name to "xxx".
INI:ffff	Set .ini file to "ffff". Only available in V3.  See below.
/gblpath:yyy	Set Mixw data directory path to "yyy". Available in V2.2 and later.

See below.
------------

Multiple parameters maybe specified:

```
"C:\Program Files\Mixw\Mixw3.exe" /2 MENU1 /setup
```

will start Mixw and initially display the Configure Soundcard box. When that is exited Mixw will then show two Spectrum/Waterfalls and use menu layout 2.

### Use of INI: and /gblpath: parameters

The **INI:** parameter is used to specify an alternate .ini file. This .ini file can be located anywhere addressable by the file system. It is read at Mixw load time and rewritten at Mixw close time. The other data used by Mixw will be in the installed data directory or referenced by full pathname from the contents of the alternate .ini file.

The **/gblpath:** parameter specifies an alternate Mixw data directory. However the .ini file used will be the one Mixw would use if no parameters were specified at load time. Any files modified (Macro files, Contest files etc.) will be written with updated contents to the directory specified by the /gblpath parameter. The .ini file will be written to its original source directory.

To use a completely different data directory both parameters must be specified:

```
{mixwexecpath}\mixw3.exe INI:{inifile pathname}\fff.ini /gblpath:{data pathname}\
```

The backslash (\) after the data pathname must be present.

### Limitation:

The *inifile pathname* and *data pathname* cannot have spaces in them. This is a limitation within the MixW3.exe code. It will likely mainly affect default MixW installations on Windows XP systems where the default folder is C:\Documents and Settings\username\Application Data\Mixw.

To overcome this limitation:

First method.

When the alternate MixW data folder is created make it in a path name that has no spaces. The data folder does not have to be installed in the default folder.

e.g. For a requirement for 3 different MixW installations.

Create a folder:

```
c:\radio\mixw_data
```

Now copy the original MixW data folder contents into this folder so the full path is

```
c:\radio\mixw_data\mixw
```

Rename the folder mixw to mixwa (Use Windows/File Explorer to do this)

Repeat the action again and copy the original MixW data folder contents into this folder.

Rename the folder mixw to mixwb.

The MixW installation on XP, assuming a default installation, will consist of the following folders:

C:\Program Files\mixw  
c:\Documents and Settings\username\Application Data\mixw  
c:\radio\mixw\_data\mixwa  
c:\radio\mixw\_data\mixwb

The command lines for the 3 different requirements will be:

"C:\Program Files\mixw3.exe" (uses the default setup)  
"C:\Program Files\mixw3.exe" INI:c:\radio\mixw\_data\mixwa\mixw2.ini  
/gblpath:c:\radio\mixw\_data\mixwa\  
"C:\Program Files\mixw3.exe" INI:c:\radio\mixw\_data\mixwb\mixw2.ini  
/gblpath:c:\radio\mixw\_data\mixwb\

Second method.

This utilises the default installation and a facility within the Windows system to relatively address files.

e.g. Same requirement as for the first method.

Assuming a default XP installation with the data in:

c:\Documents and Settings\username\Application Data\mixw (*default\_data*)

Create two folders:

c:\Documents and Settings\username\Application Data\mixwa  
c:\Documents and Settings\username\Application Data\mixwb

Copy the *default\_data* into the newly created folders (don't forget the subdirectories)

The command line for the 3 different requirements will be:

"C:\Program Files\mixw3.exe" (uses the default setup)  
"C:\Program Files\mixw3.exe" INI:..\mixwa\mixw2.ini /gblpath:..\mixwa\  
"C:\Program Files\mixw3.exe" INI:..\mixwb\mixw2.ini /gblpath:..\mixwb\

## General Operation

---

**In early versions of MixW Help from the menu bar was not always visible.**

**Mixw uses two different menu layouts. If Help is not available change your menus to look like this:**

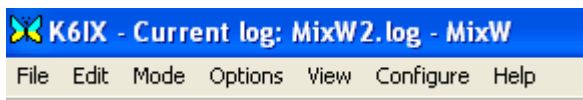

**If the Help menu is not visible in the main Mixw menu bar, select:  
View | Menu and choose Layout 1.**

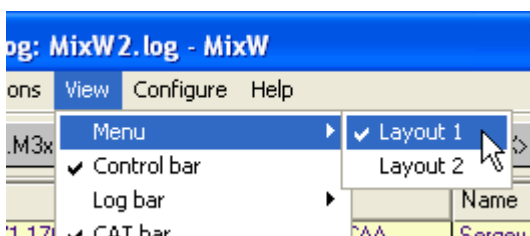

Read these general instructions first to get familiar with MixW operations , then look in the Digital Modes section of this help file for the specific mode you want to operate.

### Mode selection

Select the mode you wish to operate by clicking Mode | <your choice of mode>:

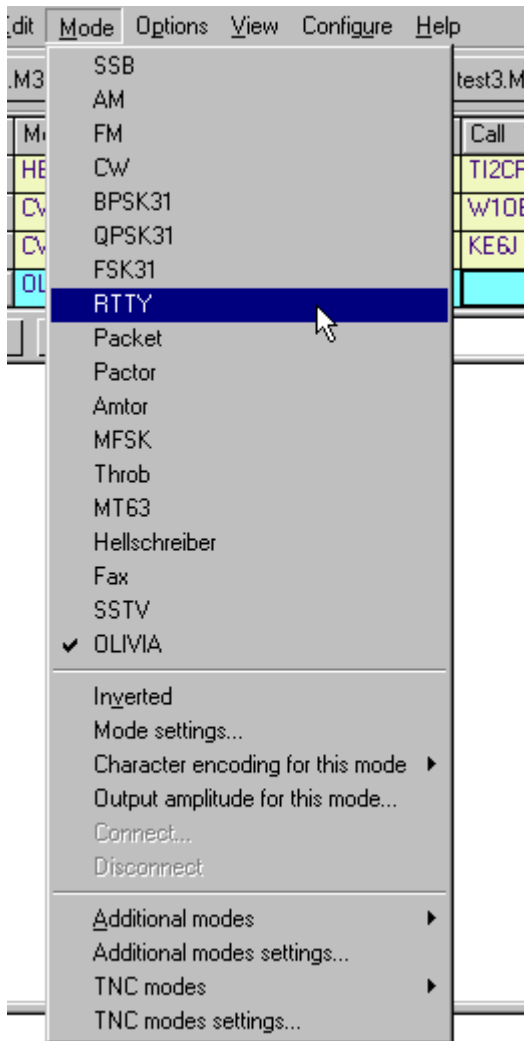

Notice that the status bar, which if displayed (see View Menu) can be found underneath the Waterfall/Spectrum window, will change according to the options and features specific to the mode you have selected, and the mode will be indicated in the mode box. For instance, IMD is only relevant in the PSK31 modes, while Connected or Disconnected is only relevant for Packet:

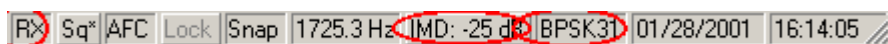

You can also switch modes by clicking on the mode box in the status bar and selecting the mode you wish to operate from the pop up menu:

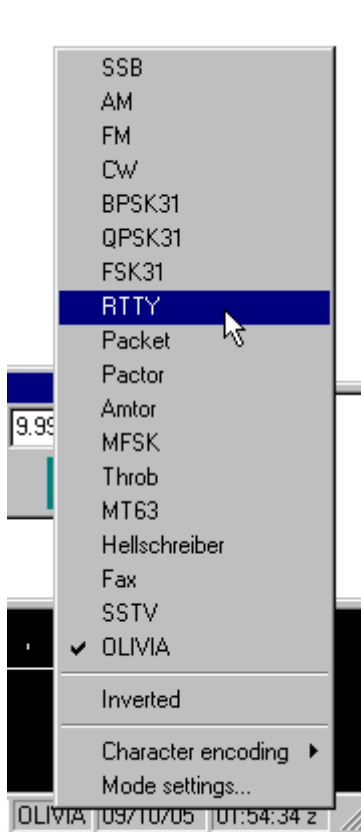

## Mode Settings

Each mode in MixW has an individual Mode Settings dialog box which can be seen by first selecting the mode, and then selecting Mode | Mode settings...

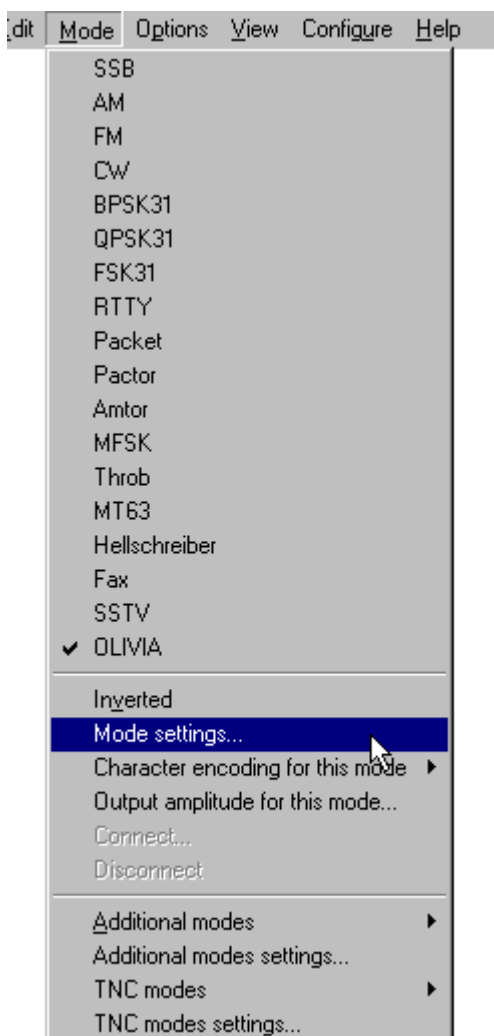



Clicking on the mode box in the status bar, and then selecting Mode settings... is another way to access the mode settings dialog.

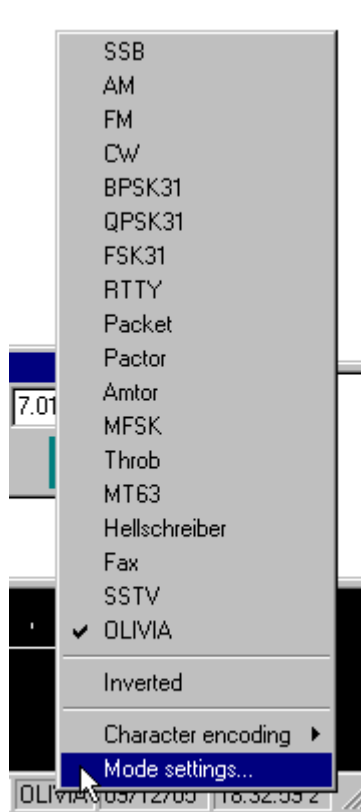

The mode settings dialog can be accessed with the MACRO <MODESETTINGS> from one of the F-key Macros. Many of the settings in each dialog can also be set from Macros as well.

The mode settings available will vary depending on the mode of operation. For instance in RTTY, you can set the shift and inversion, which are not relevant options to the BPSK31 mode.

**Note:** The TX frequency and RX frequency are interpreted in different ways dependent on the mode. For MT63, Contestia, Olivia, RTTYM and SSTV the value shown is the lowest frequency of the signal. For all other digital modes the frequency shown is the centre of the signal.

If the TX or RX frequencies are referenced at all during mode switching operations care must be taken to ensure the correct frequency position is used.

However use of the audio frequency macros will always align the centre of the signal to the value in the macro.

### **Inverted:**

**Note:** This feature works differently in MixW than most other SoundCard digital programs, so please read and understand the information about [inversion](#) in the Configuration Section.

### **Receiving**

While tuning instructions are somewhat mode specific and therefore covered in the individual mode operation topics, there are several procedures and techniques relevant in all modes.

To tune a signal left click the mouse pointer on the signal in the waterfall or spectrum display. You should start seeing text in your receive window. You can fine-tune the cursor location by holding down the control key and using the right and left arrows keys.

**Note:** The RX cursor can be locked by use of the <RXLOCK> macro (see Macros section of the Help document).

## Seek

Stations may also be tuned in by assigning the <SEEKLEFT> and <SEEKRIGHT> macros to individual function keys, preferably single-finger keys. Pressing the key assigned to <SEEKRIGHT> will cause the cursor to jump to the next signal to the right of the current cursor position. Pressing the key assigned to <SEEKLEFT> will cause the cursor to jump to the next signal to the left of the current cursor position. Seek will send the cursor to any signal strong enough for Seek to detect. If the cursor seems not to move, there may not be a detectable signal in the direction of Seek. If Seek passes the station you want to tune, or tunes to one side of the station and not in the middle, just press the Seek button to pass the station and approach it from the other side. The default keys for Seek are F11 and F12, labeled << and >>.

When Options | Arrows for Seek is checked, the left and right arrow keys can be used for the Seek function, releasing F11 and F12 for other one-finger macro key configurations. However, if the left and right arrow keys are used for Seek, they are not available for editing the TX and RX windows.

When Options | Continuous Seek is checked, Seek will search continuously for a signal and stop when it finds one. To manually stop Continuous Seek, just press any Seek key.

## Bookmarks

A place-holder called a Bookmark is available on either the spectrum or waterfall displays. You must first enable bookmarks by clicking on View | Spectrum | Bookmarks. Then, to place a bookmark at the cursor position right click in the spectrum/waterfall window and select "Toggle Bookmark" from the pop-up menu. A lettered bookmark will appear at the diamond cursor position at the bottom of the Window. Pointing to any bookmark, clicking the right mouse button, and again clicking the "Toggle Bookmark," will remove a bookmark.

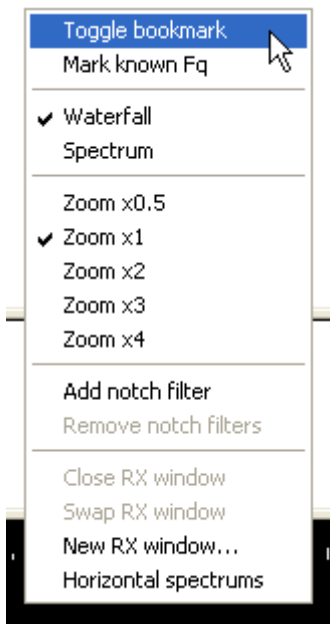

To return to a book-marked frequency, point to the numbered bookmark and click the left mouse button to position the diamond cursor there, or click the right mouse button to position the triangle cursor there (see Multiple RX Windows below).

You can capture the station's call sign for a bookmark by double clicking the call in the receive window (the call will also be captured automatically in many cases). The station's call will now appear in the bookmark when tuned to that frequency.

A special "permanent" bookmark can be placed at known frequencies by adding an entry to the KnownFqs.dat file. Known frequency bookmarks are colored grey.

When the Bookmark macro is assigned to a key, pressing that key will place a bookmark at the diamond-

shaped cursor's position.

## Clear

Text in the RX window can be cleared by right clicking in the window and selecting Clear all from the pop-up menu, or by using the <CLEARWINDOW> macro, which is configured as one of your default macros (F8). Simply place the cursor in the RX window and then click on the Clear macro button (or press the F8 key).

## Multiple RX Windows

CTRL-clicking the left mouse button in the receive window will put MixW into dual RX mode and open a second RX window named RX (1). If you are pointing at a signal when you CTRL-Left click, you will start copying that station in the RX (1) window immediately. If you already have a second RX window open CTRL-Left click will move the RX (1) triangle cursor to the signal that you click on.

Right clicking in the spectrum window, and selecting "New Receive Window" will also launch the second receive window, as well as a third, fourth, fifth etc... There are unlimited RX windows available.

**Note:** Although more than 9 windows maybe opened the 10-19 will all be marked as 1 in the waterfall/spectrum display.

Here are three QSOs being copied simultaneously in the Main, RX (1), and RX (2) windows. Note the cursor locations of each on the waterfall display:

The screenshot shows the K4SET - MixW software interface. At the top, there is a menu bar with options: File, Edit, Mode, Options, View, Configure, Help. Below the menu bar is a table with columns: Mode, Freq, Date, UTC Time, Call. The table contains the following data:

Mode	Freq	Date	UTC Time	Call
BPSK3	14070.1	01/28/2001	16:38:37	

Below the table, there is a search bar with "RX (1) BPSK31" and a "Sea" button. The main window displays text from a QSO: "...AA7w. KH1 Huston, Bonb in Beutte montana.. Yes i get y pou 599 in Butte ee. o How us the wx in MO.. I have two daugt ters in M o, One is a prof a UM at wite chai .. BTU WOLPR DE AA7Le-Koo eiei eanothehee ie o". A red arrow points to this text with the label "Very weak station just turned it over." Below this, there is another QSO: "BTU VE2WP DE AA8QQ K tmvPn AA8QQ AA8QQ AAeIQQ de VE2WP VE2WP". A red arrow points to this text with the label "Main RX window." At the bottom, there is a spectrum display with a frequency scale from 0 to 2000. Three red circles are drawn around the spectrum, with red arrows pointing to them from the labels "RX (2) BPSK31", "RX (1) BPSK31", and "Main RX window." The RX (2) window is titled "RX (2) BPSK31" and contains the following text: "e teo,t1 CQ CQCQ DE Vnve2atd de KK8WVd VE2ATD VE2ATD pse k e ieae l t f treve2atd de KK8WVve2atd de KK8WV ve2atd de KK8WV k eea oe t e KG8WV <CALL< DE VE2ATD VE2ATD GA OM es Tu for the call. Third QSO Name is Yves Y nes and QTH is Laval Laval". The RX (1) window is titled "RX (1) BPSK31" and contains the text: "e teo,t1 CQ CQCQ DE Vnve2atd de KK8WVd VE2ATD VE2ATD pse k e ieae l t f treve2atd de KK8WVve2atd de KK8WV ve2atd de KK8WV k eea oe t e KG8WV <CALL< DE VE2ATD VE2ATD GA OM es Tu for the call. Name is Yves Y nes and QTH is Laval Laval". The RX (2) window is titled "RX (2) BPSK31" and contains the text: "e teo,t1 CQ CQCQ DE Vnve2atd de KK8WVd VE2ATD VE2ATD pse k e ieae l t f treve2atd de KK8WVve2atd de KK8WV ve2atd de KK8WV k eea oe t e KG8WV <CALL< DE VE2ATD VE2ATD GA OM es Tu for the call. Name is Yves Y nes and QTH is Laval Laval". The spectrum display shows a frequency scale from 0 to 2000. Three red circles are drawn around the spectrum, with red arrows pointing to them from the labels "RX (2) BPSK31", "RX (1) BPSK31", and "Main RX window." The RX (2) window is titled "RX (2) BPSK31" and contains the text: "e teo,t1 CQ CQCQ DE Vnve2atd de KK8WVd VE2ATD VE2ATD pse k e ieae l t f treve2atd de KK8WVve2atd de KK8WV ve2atd de KK8WV k eea oe t e KG8WV <CALL< DE VE2ATD VE2ATD GA OM es Tu for the call. Name is Yves Y nes and QTH is Laval Laval". The RX (1) window is titled "RX (1) BPSK31" and contains the text: "e teo,t1 CQ CQCQ DE Vnve2atd de KK8WVd VE2ATD VE2ATD pse k e ieae l t f treve2atd de KK8WVve2atd de KK8WV ve2atd de KK8WV k eea oe t e KG8WV <CALL< DE VE2ATD VE2ATD GA OM es Tu for the call. Name is Yves Y nes and QTH is Laval Laval". The RX (2) window is titled "RX (2) BPSK31" and contains the text: "e teo,t1 CQ CQCQ DE Vnve2atd de KK8WVd VE2ATD VE2ATD pse k e ieae l t f treve2atd de KK8WVve2atd de KK8WV ve2atd de KK8WV k eea oe t e KG8WV <CALL< DE VE2ATD VE2ATD GA OM es Tu for the call. Name is Yves Y nes and QTH is Laval Laval".

The spectrum window cursor for RX 1, 2, 3 etc... is a triangle (instead of a diamond) with the RX window number directly below the triangle.

If you wish to make contact with a station being copied in one of the RX (n) windows you can swap between the Main RX window and the RX (n) window by right clicking in the RX (n) window and selecting Swap from the pop-up menu.

You can only be transmitting to one station at a time.

When MixW is in multiple RX mode, it may be returned to single RX mode by closing the extra receive windows.

### Positioning and Sizing Windows

**NOTE:** Before making changes to your MixW layout it is important to back up the MixW2.ini file so you can revert to your previous setting if necessary.

Pointing to a vacant space on the Control Bar, Log Bar, Tuning Indicator, or World Map and holding the left mouse button down while moving the mouse makes it possible to reposition and dock any of these features. An outline of the feature will appear when the mouse is first moved, and when that outline shrinks, it indicates a position where the feature may be docked by releasing the mouse button. The docked position of the feature will be remembered from session to session. These windows can also be undocked by double clicking on an empty space in the window.

The number of rows visible in the log bar can be changed. Double click in a blank area of the log bar to undock it. Resize the log bar for the number of rows you want. Double click the log bar again to redock it.

Reducing the font size will also enable more log entries to be visible.

Pointing to a window separator will cause the mouse cursor to change to a small pair of parallel lines, and pressing the left mouse button and keeping it pressed will make it possible to resize the Spectrum, TX or RX windows. Releasing the mouse button will leave the window in the resized position.

The following screen indicates one approach to screen layout using the various MixW displays:

The screenshot shows the MixW software interface with the following components labeled:

- Control Bar (Macros):** A row of buttons including AutoCQx, CQ, Call 3, Call, Info, Brag, Bye, Clear, TX, RX, <<, and >>.
- Log:** A table with columns: QSO, Mode, Freq, Date, UTC, Call, Name, QTH, RST\_Sent, RST\_Recv, Notes. It contains three entries.
- Main receive window:** A text area displaying a message: "it was very warm. Oh, well, in another couple of months we will be complaining that it is too cold. The rig here is a TS570DG and I've had it about 5 months or so. I'm new to".
- Transmit window:** A text area for entering transmission text.
- World map:** A globe showing the current location (TI, NA-7-11, 121°).
- Tuning indicator:** A circular display showing signal strength and RST: 556.
- Status bar:** Displays TX, Sqr, AFC, Lock, Snap, 1165.7 Hz, IMD, BPSK31, 07/26/05, 00:54:00 z.

QSO	Mode	Freq	Date	UTC	Call	Name	QTH	RST_Sent	RST_Recv	Notes
1	BPSK3	14070.948	07/26/05	00:16:21	N3EBZ	FRANK C	NEWPORT	599	599	
2	BPSK3	14070.948	07/26/05	00:50:31	N9PMW	CHARLE	INDIANAPOLI	599	599	
3	BPSK3	14071.166	07/26/05	00:51:13	TI8CBT			599	599	

### Icons in the Calling Station Information window.

Small icons are shown to the left of the station information which indicate the DX status of the station. The status is also explained in the text. A star indicates a new DXCC entry, a star with the letter M indicates a new country in the current mode, and the letter B indicates a new country on the current band.



### Icons in the MixW receive window.

Small icons can be shown along with the text in the MixW RX window. These icons are in the MixW | ICONS folder and are configured to appear after a text word by placing the word and the icon name in the MixW | icons.cfg file.

You can add your own icons by putting your icons in the ICONS folder, and then identifying the icon in the icons.cfg file. Open the icons.cfg file with Notepad (or some other text editor) and follow the format used for those entries already in the file. You can create your own icons by downloading one of the many Icon Editor programs available on the internet.

Remember that **these icons are visible only in the RX window of the station where they have been created and stored.** If you see them in your RX window it is because they are in **your ICONS folder.** The other station will see them only if they are also in **his/her ICONS folder.** **They are not sent over the air.** You can test your icons by running MixW without the transceiver on. Type the words for which you have made icons into the TX window and then switch MixW to TX. As the text is copied into the RX window you will see your icons. In the illustration below you see that I have added an icon which is a large "X", and equated it to the text prosign "sk".

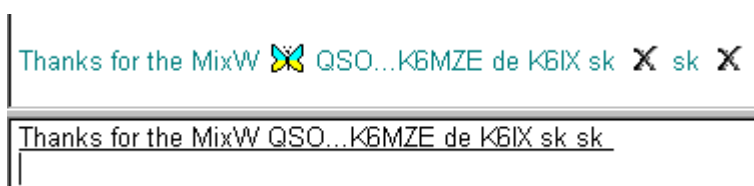

### Notch Filters in the Spectrum/Waterfall window.

To set an Audio Notch Filter, right click in the Spectrum or Waterfall window at the frequency to be notched and select Set Notch Filter from the menu. Multiple filters can be set using this method. To clear **all** the filters you have set, right click anywhere in the Spectrum/Waterfall window and select Clear Notch Filter. Filters can not be cleared individually.

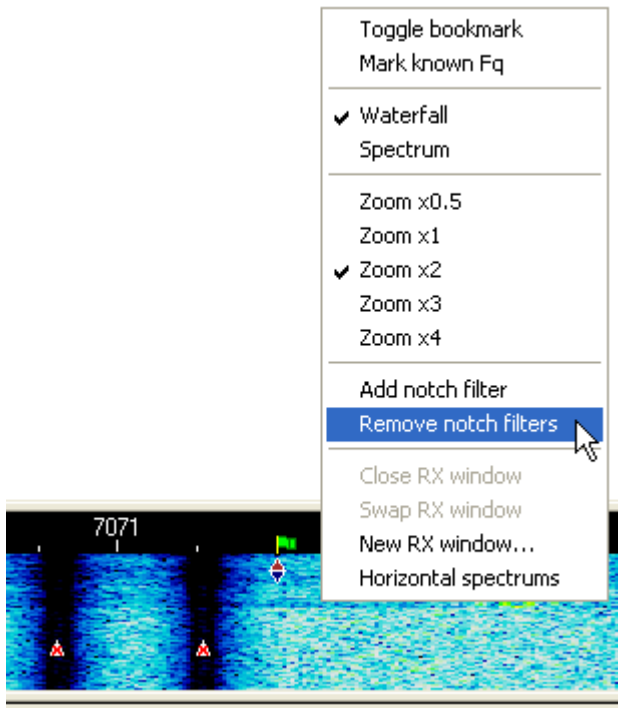

### Grid Location Distance and Azimuth.

Hovering the mouse pointer over a Grid Location in the RX window will show a tool tip with the Distance and Azimuth.

### Transmitting

The active cursor for transmit is denoted by a green flag on the dial scale above the cursor. The transmit frequency may also be locked in place. When locked the flag will change to red color, warning you to notice the actual transmit frequency.

To transmit to a station, first tune it in, and then type outgoing text in the Transmit Window, (the smaller window between the Receive Window and the Spectrum Window). Press the TX/RX button on the status bar (or one of the other TX/RX toggles) and the text in the Transmit Window will be transmitted. You can continue to type, and that text will also be transmitted.

As it is being transmitted, text in the transmit Window will also appear in the Receive Window. To stop transmitting, click the TX/RX button again with the mouse. Pressing ESC (on the computer keyboard) TWICE will abort transmission and return MixW to receive mode, but the last several characters typed will not be transmitted. For this reason, the TX/RX button should normally be used to switch from transmit to receive.

When transmitting, the waterfall will freeze and remain frozen until returning to Receive.

Text in the TX window may be edited with the standard Windows editing functions while in the TX mode. **Enabling View | Underline Sent Text** will prevent you from inadvertently trying to edit text that has already been sent (some users report, that on their systems, View | Underline Sent Text **must** be enabled to edit in the TX window).

**NOTE:** After editing in the TX window be sure to put the cursor at the end of the text you want to send. TX will stop if the cursor is encountered.

Text in the TX window can be deleted or Cleared by right clicking in the TX window and selecting Clear all, or by using the <CLEARWINDOW> macro, which is configured as one of your default macros (F8). Place the cursor in the TX window and then click on the Clear macro button (or press the F8 key).

### TX Operation with Multiple RX Windows

To avoid the possibility of transmitting to the wrong station, MixW supports only one transmit frequency. You can switch TX (the diamond cursor) to any RX window by swapping the RX (n) window with the

main window.

### **TX Lock**

Lock can be used for what is normally referred to as "Split frequency" operation, or transmitting on one frequency and listening on another. In order to set the transmit frequency, position the diamond cursor to the frequency where you want to transmit and click Lock on the status bar. Then move to the frequency where you want to receive or where there is a station of interest and left click to start RX in the normal manner. The receive frequency will show a red triangle cursor and the transmit frequency will show an inverted blue triangle with a red flag.

To unlock TX, click the Lock button on the status bar again. The TX frequency will revert to your current RX frequency and the flag will turn green.

### **VFO B and Split Mode**

MixW provides a number of macros to enable a transceiver with two VFOs to have the frequency for VFO B to be copied from VFO A or set independently. There are some limitations to the facilities within MixW for setting VFO B but some may be overcome by use of the <CATCMD:> or <CATCMDHEX:> macros.

Macro <FQB:fq in khz> will set the VFO B frequency. It does take a + or - value in the parameter but the frequency set will not be the current VFO B frequency +/- the parameter value in khz but the VFO A frequency +/- the parameter, which is the same action as <CATVFOSYNCONCE:fq in khz>.

To copy the VFO A frequency to VFO B use <CATENABLEVFOSYNC> but this will continually copy the frequency from VFO A to VFO B. Use <CATDISABLEVFOSYNC> to stop the copy action.

To copy the VFO A frequency to VFO B with an offset in khz, possibly to set up for a split operation, use <CATVFOSYNCSHIFT:+/-value in khz>. Once again though this action continues until <CATDISABLEVFOSYNC> is executed.

To copy the VFO A frequency to VFO B once only use <CATVFOSYNCONCE:fq in khz>. The frequency can be an absolute frequency or +/- for relative changes.

**Limitation 1:** Where there is a possible +/- frequency adjustment in the above macros a value of 0, +0 or -0 will not result in a straight copy of VFO A to VFO B but MixW will write the VFO A frequency to VFO A (a pointless action).

**Limitation 2:** When a relative value is specified the frequency set will also include the value of the Audio Frequency.

**Limitation 3:** Not all transceivers will set the VFO B frequency unless VFO B has been selected in the transceiver prior to the VFO B frequency set command.

To overcome this it is necessary to either manually select VFO B using the transceiver front panel control or to use the macro <CATCMD:> or <CATCMDHEX:> to send the transceiver the command to tell it to select VFO B before sending the select VFO B frequency command, then send a command to select VFO A again.

A typical sequence could be:

<CATENABLEVFOSYNC> - Must be prior to the VFO B selection.

<CATCMD:sel VFO B>

A separate sequence is then needed to stop the action:

<CATDISABLEVFOSYNC> - Order immaterial.

<CATCMD:sel VFO A>

This second sequence must be in a separate macro button.

**Limitation 4:** If a series of macro commands like: <CATENABLEVFOSYNC><CATCMD:sel VFO B><CATDISABLEVFOSYNC><CATCMD:sel VFO A>

are created in a single macro they will not perform the required action. VFO B will be unchanged.

**Sequences that do work:** The macro sequence:

<CATCMD:sel VFO B><FQB:value in khz><CATCMD:sel VFO A>

and

<CATCMD:sel VFO B><CATVFOSSYNCONCE:value in khz><CATCMD:sel VFO A>

It is recommended if the activity of copying VFO frequencies between VFOs is required to use the facilities available within the transceiver using the <CATCMD:> or <CATCMDHEX:> macros.

### Split operation

There are a number of minor differences in the methods used to implement Split Mode working even within transceivers from the same manufacturer. Read the operation manual first before attempting to use Split Mode for the first time.

MixW supplies a number of macro commands (see above) to facilitate setting frequencies and a macro <SPLIT:0/1> to action the split.

### Operating With Macros

The MixW Macro Buttons in the Control Bar allow for the automation of almost all frequently used operating procedures. The Macros can be executed by using the keyboard F1 thru F12, Ctrl-F1 thru Ctrl-F12, Shift-F1 thru Shift-F12, or Ctrl-Shift-F1 thru Ctrl-Shift-F12 keys. The macros can also be executed by (mouse) clicking on the buttons in the control bar in which case the different rows can be displayed before clicking by pressing the Shift, Ctrl, or Ctrl-Shift keys, or by rolling the mouse wheel while the pointer is hovered over the control bar.

For information on customizing Macros see the [Configuring Macros](#) topic in the Configuration and Set Up section.

### RXLog facility

Enabling RXLog, either from the File menu or one of the <RXLOGSTART> macros causes all text that appears in the RX window to be saved to the named file. The file can then be opened with a text editor (Wordpad.exe is recommended as Notepad.exe does not correctly interpret the method MixW uses to write newline characters).

This is a useful facility for use in contests to enable verification of incorrectly logged exchanges and checking on unexpected dupes.

**Note:** Once started the logging will continue across MixW stops and starts and large files can be created.

## File Menu

---

**A short description of some of the selections available from the file menu:**

**Print (CTRL-P)** Prints the contents of the Receive window to the printer. **Note:** The cursor MUST be in the RX window.

**Print Preview:** Displays an image of the printed page.

**Print Setup:** Displays a dialog for setting printer parameters.

**Add QSL to current print queue (Ctrl-Shift-P):** Adds the selected QSO to the QSL print queue.



**Extras:** V2.2 and later.

Opens dialogue to download extra Mode dlls, Contest stats or languages.

**Send File:** Transmits the contents of a specified text file. **This must be text only!** Be sure to always "close" your file by saving it to disk.

**Send Picture:** Displays a dialog to send a picture in MFSK

**YAPP:** Send or Receive YAPP.

**Run Script:** Execute a script file.

**Search in log file (ALT-R):** Displays the "Search in Logfile" dialog allowing you to search for any string in the log.

**QSO details (ALT-D):** Displays a dialog showing all fields in the log for the selected Log bar QSO. This dialog also allows adding a new call area, or sending an eQSL.

**Remove QSO (Alt-O):** Deletes the selected QSO.

**Restore removed QSO** Restore the last deleted QSO.

**Save QSO (Alt-S):** Saves the contents of the active log entry.

**Lookup call (Alt-K):** Looks up the active call in the log and displays all previous contacts.

**Import ADIF:** Imports a log in [ADIF format](#). The ADIF format is common to many log programs, and can be used to exchange logs between different programs.

**Note:** After an import check for a file BadAdif.txt in the MixW default data folder. A failure to import individual QSOs maybe logged in this file.

**Export ADIF:** Exports a log in [ADIF format](#) for import to another program.

**Merge:** Will merge two MixW2 logs together.

**Backup Log:** Will access the backup.pwd file for the password to use to copy the log file, in .adif file format, to the Mixw site.

**Restore Log:** Will access the backup.pwd file for the password to use to retrieve the log file, in .adif file format, from the Mixw site.

**Save Config:** Will bring up a dialogue to save the mixw configuration data to a file. The save will not take place until MixW exits when the current MixW configuration will be saved to the new file. In MixW2.2 and later it will also lead to a change in the MixW2StartUp.cfg file, which contains a pointer to the MixW2.ini file.

**Load Config:** Will bring up a dialogue to load a previously saved mixw configuration file. MixW will be stopped and restarted with the new file data immediately. As in the Save Config menu item (above) in MixW2.2 and later the MixWStartup.cfg file will be changed with the new MixW ini file replacing the existing one.

**[RX Log:](#)** Opens or closes a file to save the receive window text data.

**Sound:** You can save the last forty seconds of audio to a wave file. This is useful in cases where you want

to demonstrate certain audio characteristics. Files can be saved, and later played back for reception and display.

**Exit:** Exits MixW

## Options Menu

---

### AFC

When AFC is checked, MixW will keep a station tuned even if it drifts. It is recommended that you keep AFC checked unless it prevents you from tuning to a desired station. Uncheck AFC if a nearby strong station makes it impossible to tune to a weaker station.

### Lock

Lock allows you to transmit on one frequency and receive on another. When Lock is selected, the TX frequency is fixed at the position of the active cursor, and the flag above the cursor changes to red. When LOCK is NOT selected, transmission will occur on the same frequency as receive, as indicated by the diamond cursor, and the flag above the cursor will be green.

### Snap

When Snap is checked, MixW will automatically find the correct tuning point for a station. Uncheck Snap if a nearby strong station makes it impossible to tune to a weaker station.

### Squelch

When squelch is checked, only signals above the Squelch threshold will be printed. This can be used to prevent random characters created by noise from being printed.

### Squelch Threshold

Displays a level control for the Squelch threshold. The threshold can be adjusted as high as possible to prevent noise from printing as random characters but still allow print of a desired station. Selecting Mode | Squelch threshold...will display a mode specific dialog in which AFC, Lock, and Snap can also be set.

When the screen-printing is "squelched", or not printing, because the signal is below the squelch threshold, the "Sq" shows on the status bar without the " \* ". If MixW appears to stop decoding, be sure the squelch threshold is not set too high. For reception of weak signals, it is usually best to turn the squelch completely off. This will result in "garbage" print some of the time, but whenever the signal becomes strong enough that copy is possible, the text will appear on the screen along with the garbage characters.

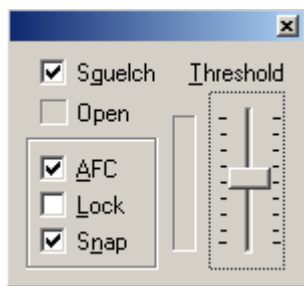

**RX** Selecting RX places MixW in the receive mode.

**TX** Selecting TX places MixW in the transmit mode.

TX and RX can also be toggled by using the pause/break key on the computer keyboard, by clicking on the RX/TX box in the Status Bar, by using the TX and RX Macro buttons, or by using the <TX> or <RX>

Macros in a Macro script.

### Continuous Seek

When Continuous seek is checked, Seek will continuously look for a station until one is found and stop on that station. To stop Seek, just press any Seek button. If a station fades below the Seek threshold, Continuous Seek does not start seeking for another station. This is so you can stay on the station's frequency and continue to copy whatever you can, even though it is fading. To restart Continuous Seek, just press one of the Seek keys or buttons.

### Arrows for Seek

When Arrows for Seek is checked, the left and right arrow keys can be used for Seek, but the arrow keys are then NOT available for editing the RX and TX window. Uncheck Arrows for Seek to make the left and right arrow keys available for RX and TX window editing.

### Scan | Start Scan

When selected, Scan will cause MixW to Seek out a station, stop on that station, record the time and tone frequency of the station, and print that station on the screen for a determined amount of time (dwell). After printing for the selected dwell time, MixW will proceed to the next detectable signal and repeat the process.

**Note: Snap must be on for Scan to work.**

### Scan | Stop Scan

Selecting stop scan will stop the Scan process. Scan may also be stopped by selecting a station or frequency with the mouse. Clicking Scan | Start Scan again will start the scan from the current location.

Start Scan and Stop Scan can also be controlled by macros, so <STARTSCAN> and <STOPSCAN> may be assigned to function keys or put into a macro script.

### Scan | Scan properties

Selecting Scan properties will bring up a dialog for setting the way Scan behaves. "Only once" will stop Scan after encountering the first detectable signal, Dwell sets the staying (to print) time in seconds, and Continue on squelch resumes scanning when the signal level falls below the squelch threshold, Checking Time Marks or Frequency Marks, tells MixW to display the time of the station print or the frequency of the station print, or both.

### Scheduler

Scheduler allows the Mixw operator to specify an Event by date and time. The Event can be a reminder or a Macro to execute.

Selecting Scheduler brings up the Events list.

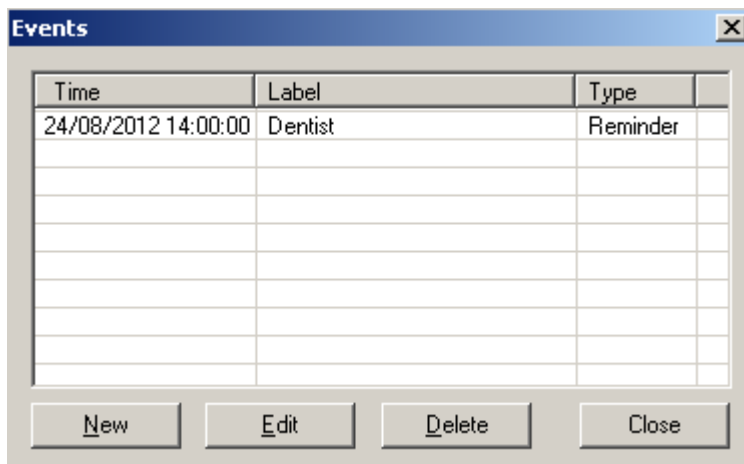

By selecting New or selecting a previously entered outstanding Event and selecting Edit brings up the Event details. Click on OK to save the details.

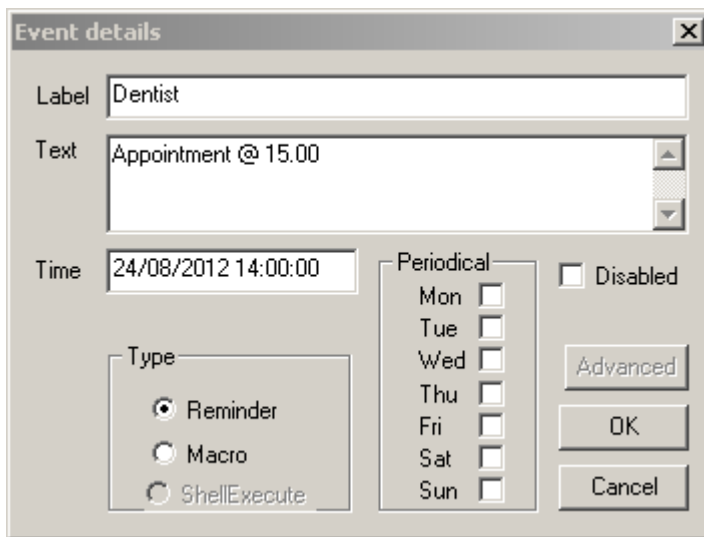

It is possible by checking the week day boxes to execute a periodic task or reminder.

**Note:** The Advanced and ShellExecute functions aren't currently available.

### Memory

MixW has the capability to store up to 20 Transceiver and Mode settings. The settings maybe saved by selecting the Memory option, using the macro <MEMW:> or using the [short cut keys](#) Ctrl-1 - Ctrl-Shift-0.

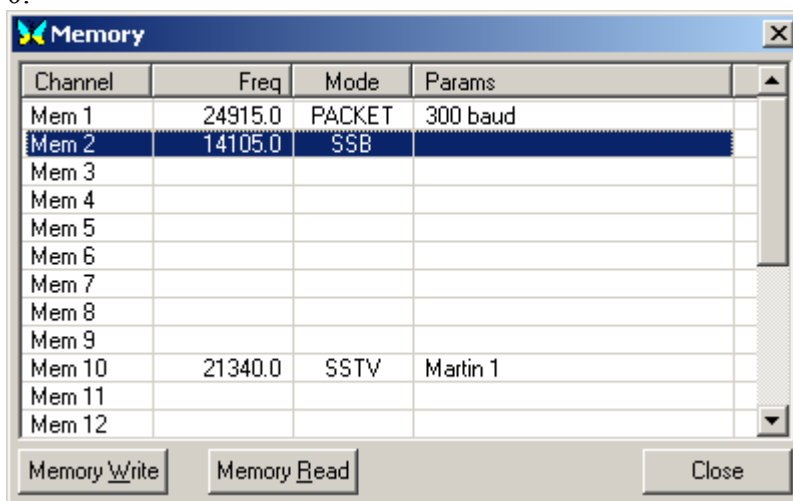

The data saved can be restored by selecting the required row then Memory Read, by use of the <MEMR:> macro or the [short cut keys](#) Alt-1 - Alt-Shift-0.

## View Menu

---

View is where you select which of MixW's various control windows and operating aids are displayed on the screen, and in several cases, how they are displayed. Simply select (check) the ones you want displayed.

### Menu

MixW has two different Menu Layouts. In early versions of MixW Help was not visible in Menu Layout 2. If the Help menu is not visible in the main MixW menu bar, select View | Menu and choose Layout 1.

### Control Bar

When checked, the Control Bar will be displayed. The Control Bar may be moved and repositioned

(docked) by pointing to an empty area of the bar, holding the left mouse button down, moving the outline of the bar until it changes shape, and then releasing the mouse button. The usual alternate docking location for the Control Bar is just underneath the Spectrum Window.

### **Log Bar**

Gives access to several settings for contest logging, and log text colors.

### **CAT Bar**

Displays current Side Band and Frequency settings for use by the Waterfall and Logging functions. Enables band switching and Transceiver Mode selection. Provides variable speed Transceiver tuning.

### **Tuning Indicator**

When checked, a phase display of the received signal will be shown. This will display as multicolored radial lines, like spokes of a wheel, when MixW is not tuned to any signal. When tuned to a BPSK signal, there will be only two vertical, or nearly vertical, spokes displayed. When tuned to a QPSK signal, there will be two vertical spokes and two horizontal spokes forming a cross, and when tuned to a FSK31 signal, two horizontal spokes will be displayed.

### **World Map**

A World Map will be displayed showing your station as a yellow dot in the location you configured under Personal Data. A line will appear indicating the location of the call in the active QSO entry of the Log. If you have configured MixW to use Rotor control, the heading of your antenna will also be displayed, and it will move with your bearing when operated through MixW.

### **DX Cluster**

The DX cluster window can be configured for packet or internet DX information.

### **Callbook dialog**

For this option to work, a callbook must first be configured by selecting Configure | Callbook, and then selecting your callbook type and its path settings. If there is an entry in the current QSO line in the log, that entry will be entered in the Call: text box when the Callbook dialog is opened. If you want a different call, type it into the Call: text box. Click the Search... button to look the call up in the callbook.

### **Status Bar**

When checked, the Status Bar will be displayed. **Note:** Right clicking in the status bar will bring up additional display options.

### **Statistics**

Give you display options for your contest statistics while in the MixW contest mode or show brief log statistics or detailed country by country statistics.

### **Quick search**

The Quick Search dialog is for searching for incomplete callsigns. Although originally intended for contest use the feature can be enabled at any time.

Select View | Quick search | Show dialog. Next select your preferred method of searching from the options by selecting View | Quick search | <preferred method>. Now with the Quick search dialog selected you can enter part of a call sign into the new QSO cell of the Log Bar. Wildcards ('\*' and '?') are allowed. Red ticks will indicate if you have already had a QSO (indicating a dupe) with this station (this will be according to the current contest settings).

An option is provided to enable the loading of a Master.dat database.

### **NCDXF/IARU Beacons**

This dialog allows you to automatically QSY your rig to the various beacons. The options reflect the active beacons based on Zulu time. Clicking on one of the active beacons will QSY your rig to that

beacon's frequency, and set the mode to CW for decoding it.

**Note:** Your computer time must be set extremely accurately to use this feature, otherwise the list will not be in sync with the beacon timing. You must also have the CAT feature properly configured to automatically QSY the rig.

### Scanner

Allows you to configure frequencies or ranges of frequencies to be scanned. The scans are initiated and terminated with macros.

### Contest mode

The contest mode dialog is used for selecting, editing or adding contest settings.

### Spectrum

Here you can change between the Waterfall or Spectrum displays as well change the colors, zoom, and RF markers. Many of these items can also be changed by Right Clicking in the waterfall or spectrum display windows.

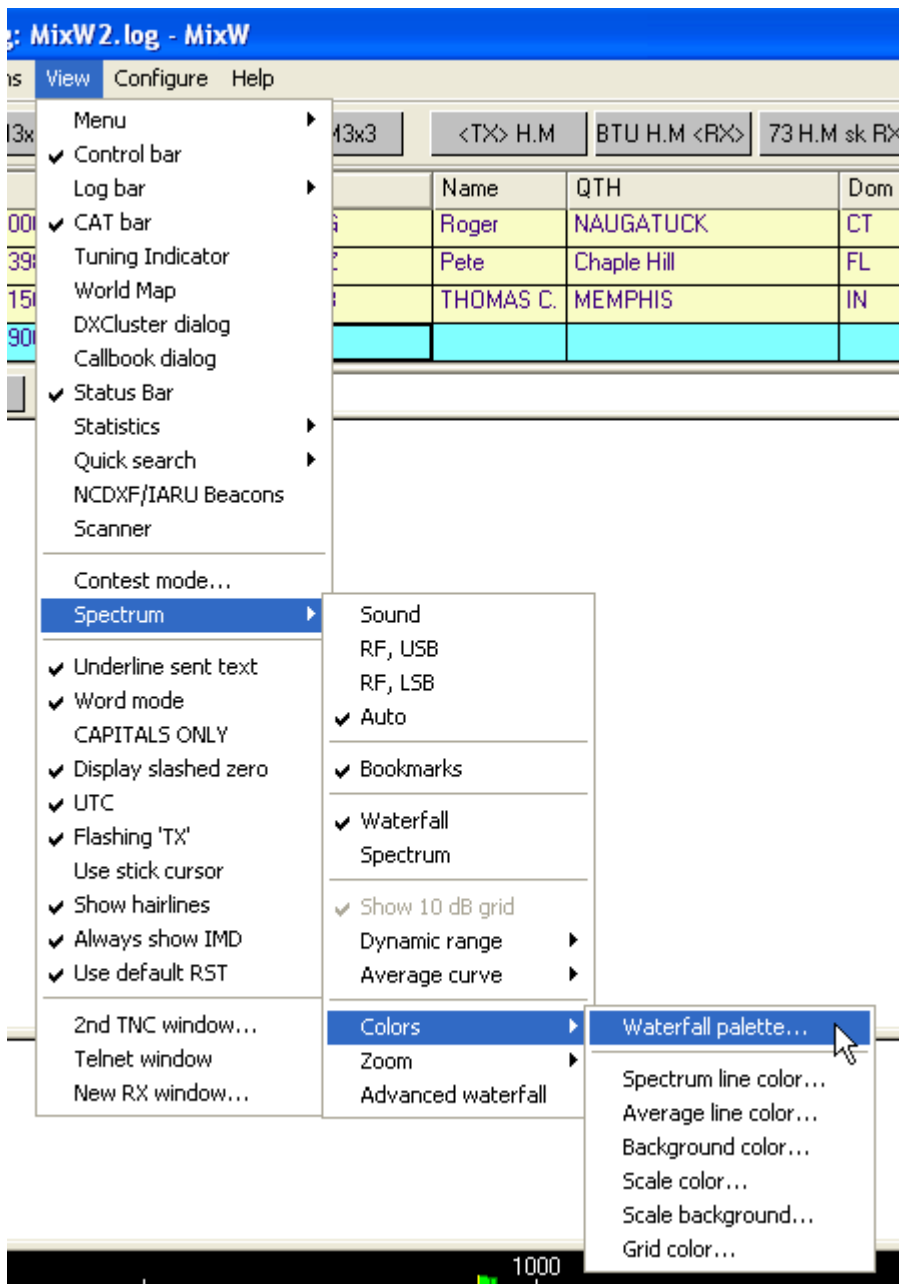

**Note:** you can also change the speed of this display in the sound card settings dialog box. Select Configure | Sound Card settings. The faster speeds require faster computers.

**Displaying spectrum frequencies and Configuring for LSB or USB operations:** The MixW options

for RF, USB/LSB should be configured to reflect your mode of operation by selecting View | Spectrum | RF, USB or RF, LSB or Auto, or Sound. These must be set correctly in order for the frequencies in the displays to represent your actual operating frequencies, and for MixW to automatically adjust the inversion settings based on your RF mode. See the information on inversion in Configuration.

### **Advanced Waterfall**

When checked the entire waterfall will move as you tune the transceiver (CAT must be enabled). This prevents the "smearing" of the signals already in the waterfall. Requires a fast computer for smooth operation.

**Note:** From MixW V2.16 onwards two waterfall/spectrum windows can be displayed by appending the parameter /2 to the MixW start up command. See [Starting MixW](#)

### **Underline sent text**

When checked, the text in the TX window will be underlined as it is transmitted. Transmitted text will also be echoed to the RX screen in a user-assigned color as configured under Configure | TX font color. The Underline sent text should be enabled if you want to edit the text that still remains in the TX buffer.

### **Word mode**

Selecting word mode prevents text from going to the transmit buffer until an entire word is typed in the TX window. This can be handy as it allows for editing a word in modes that do not support the backspace key, such as RTTY and AMTOR.

Word mode is only available when using the Underline sent text option as described above. Also, when using word mode, several Macros will require a space to be present after the Macro command itself in order for it to be sent to the TX buffer properly.

### **CAPITALS ONLY**

Selecting CAPITALS ONLY will automatically convert any lower case characters entered in the TX window to upper case when sent to the TX buffer. This is handy for the RTTY and AMTOR modes, which only support upper case characters.

### **Display Slashed Zero**

Provides the user a choice of styles for the numeric zero.

### **UTC**

Causes the time displayed on the right end of the status bar will be in Universal Coordinated Time. When unchecked, will be in local time. If the clock of the host computer is set to UTC instead of local time, the Time Zone setting under Windows needs to be set to GMT and adjustment for "daylight savings changes" disabled.

### **Flashing 'TX'**

The 'TX' indicator for transmit on the status bar will blink on and off. When unchecked, the 'TX' indicator will not blink.

### **Use Stick Cursor**

Will turn the mouse pointer to a thin stick while in the waterfall display. This can facilitate placing the tuning diamond in the middle of a signal.

### **Show hairlines**

Selecting Show Hairlines causes hairline tails to extend down from the tuning indicators (from the top to the bottom of the waterfall display). These can be an aid to tuning certain signals.

### **Always show IMD**

Will display the IMD reading constantly when receiving a PSK31 signal instead of just during the idle tones. However, the idle tones are the best time to determine the station's IMD.

## Use Default RST

Will send the default RST when the RST Macro is used, instead of asking for your RST report.

## 2nd TNC window

Selecting this option displays a 2nd TNC window.

## Telnet Window

Opens a window allowing the user to initiate a Telnet session over the internet. This could be a Telnet DX Cluster, or any other standard Telnet communication. An internet connection must already be open.

## New RX window

Opens an additional RX window tuned to the frequency currently selected in the waterfall display.

# Status Bar Use

The bottom frame line of the MixW screen displays the Status bar if selected in the View menu.

The left part of the status bar displays the call, name and qth of the current QSO (if entered), the right part information pertaining to the current mode, date and time.

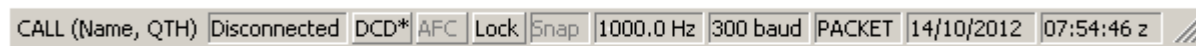

By right clicking on any part of the status bar **apart from the mode** this menu may be displayed. It allows selection of UTC or local time display, whether the TX is steady or flashes, and mode specific control selection of Lock, Snap, AFC, Squelch and Squelch threshold.

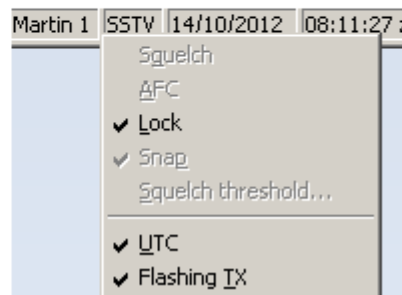

**TX/RX or Connected/Disconnected:** In all modes except Packet, the leftmost box indicates either TX or RX depending on the current status of MixW, and transmit and receive can be toggled by clicking on this indicator box. In Packet mode this box indicates Connected or Disconnected

**Squelch) or DCD** In all modes except Packet this box displays the Squelch setting. Squelch can be toggled on or off by clicking on the Sq box, and the threshold can be set by right clicking on the Status Bar and selecting "Squelch Threshold" from the Pop Up menu:

Clicking on Squelch Threshold pops up the following box:

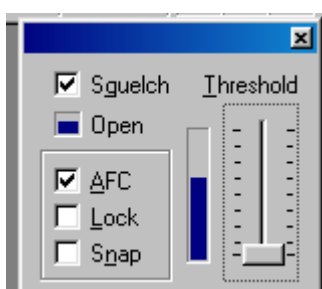



In addition to setting the Squelch threshold, AFC, Lock and Snap can also be set from this pop up dialog.

If MixW appears to stop decoding, be sure the squelch threshold is not set too high. For reception of weak signals, it is usually best to turn the squelch completely off. This will result in "garbage" print some of the time, but whenever the signal becomes strong enough, the text will appear on the screen along with the garbage characters.

In Packet mode this box displays DCD. The DCD setting can only be adjusted by going into Mode settings then select the Modem tab.

**AFC, Lock, and Snap** are fixed for all modes. They can be toggled for the modes in which they are available by clicking on their boxes in the Status Bar.

**Frequency:** The current audio operating frequency is indicated in Hz. This represents the offset from your transceiver's zero beat frequency you are operating on.

#### **Mode specific data:**

A number of modes display no data in this box (FM, CW, SSB, FSK31, and MFSK) which is shrunk to a minimum size.

The other modes, apart from PSK modes and SSTV, show a value pertaining to the throughput of the mode.

SSTV shows the current SSTV mode.

#### **IMD:**

IMD is only available in PSK modes and a value will only be displayed if menu View|Always show IMD is ticked. Clicking on the IMD box will freeze the IMD at the last observed value. Clicking on it again will activate the IMD reading again.

The macro <IMD> will insert the displayed IMD value into the transmitted text only if the IMD display is frozen.

IMD is a measure, in dB, of the level of the first pair of unwanted sidebands (at +/-46Hz from the center-frequency) compared to the main pair of wanted sidebands (at +/-15Hz). The readout is accurate only when the signal is idling, and at that time, the emission is actually the same two-tone signal that is used for checking the quality of SSB transmitters, and the IMD dB figure is the same as the third-order intermodulation performance figure given for SSB transmitters.

**IMD readings are only accurate, and only display when the station is idling, and there is not another station very close in frequency, and when the S/N ratio of the received station is about 20 dB or greater.** Typical IMD readings are -25 dB to -30 dB for a well-adjusted transceiver, and readings of -20 dB or worse indicate that the transceiver's extra sidebands can cause QRM to adjacent stations.

Left clicking on this box in CW, FSK, RTTY, Packet, Pactor, Amtor, MFSK, Throb, MT63, Hellschreiber, Fax, SSTV, RTTYM, OLIVIA and CONTESTIA modes will bring up the Mode settings dialogue box.

**Mode:** The current operating mode is indicated in the box to the left of the Date.

**Date:** The current date is displayed.

**Time:** The current time is displayed. By right clicking the status bar, you can select to display UTC or

Local time.

## Logging and QSLing

MixW's Logging features make it easy to keep track of all your QSOs. The contest mode will track your contest progress, complete with multipliers, while automatically checking for DUPs and auto-incrementing serial numbers for exchanges. The normal mode can track your regular ragchewing and award hunting contacts.

The **Log Bar** can display up to 20 items of the [log file entry](#) and is capable of showing up to the previous 24 QSOs. You can design 4 different log bar layouts and select the one you want for a particular purpose from View | Log Bar | Normal/Contest/Custom 1/Custom 2.

QSO	Mode	Freq	Date	UTC	Call	Name	QTH	Dom	RST_S	RST_R	Notes
322	HELL	14079.600	10/08/04	23:48:48	KG4WNA	John?			599	599	could not copy
323	CW	14058.651	10/09/04	00:04:32	W4POS	WILLIAM D	JACKSONVILLE	FL	599	599	little too fast but I got it
324	MFSK	14072.036	10/14/04	00:07:18	WA9HCZ	JEROME C	ONALASKA	WI	599	599	too much qsb
325	CW	14100.000	10/21/04	01:28:17					599	599	

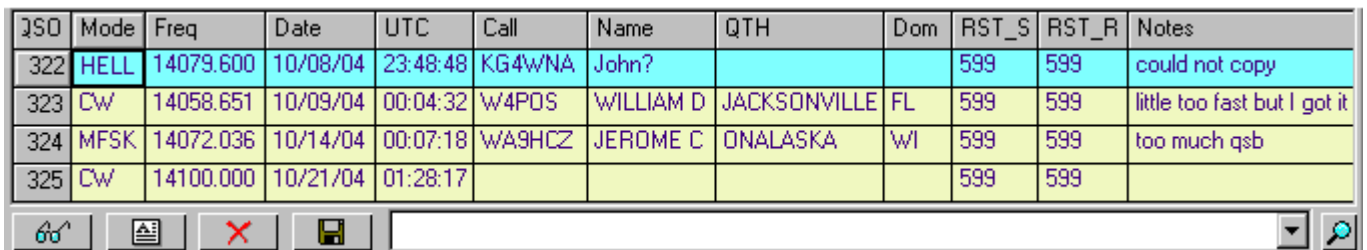

The Log Button Bar which appears at the bottom of the Log Bar controls several log functions.

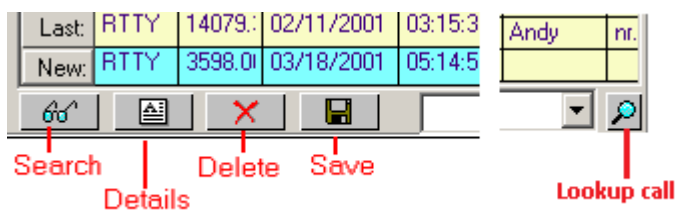

**Search** allows you to search the log for a callsign.

**Details** will bring up the full log information for the selected QSO. This allows changes to the data to be made and saved.

**Delete** will delete the selected QSO.

**Save** will save the New QSO line to the Log. If the line selected in the log bar is not the current (unsaved) QSO a prompt will be displayed to make sure you really want to delete a saved QSO.

**Lookup call** performs a log search for other QSOs with the call selected in the log bar.

**Note:** To scroll all the entries in your log click Search (eyeglasses) and then click the Whole Log button. To see all the fields in a log entry click Details ('A').

Since there are too many fields in each log entry to put in a single line across the page you must [choose](#) the set of fields you want to display, and the width you want each field.

Up to 25 lines may be shown in the log bar. Double click in a blank area of the log bar to undock it. Resize the log bar for the number of rows you want. Double click the log bar again to redock it. Reducing the log font size will also enable further lines to be displayed.

The latest versions of MixW have an added facility to the log bar. By right clicking on an entry a pop up menu of four entries is displayed:

RT3P	599	599	
UA3GIE	599		Edit RT3P
RG3R	599		QRZ.COM RT3P
UA6AKD	599		Google Map RT3P
RA3NC	599		Search RT3P

The **Edit** entry brings up the Details Window.

**QRZ.com** activates an internet connection to QRZ.com with the callsign as the database parameter.

By changing the MixW2.ini line:

QrzPage=http://qrz.com/db/

it is possible to call a different website, providing the last part is a callsign (e.g.

QrzPage=http://www.eqsl.cc/Member.cfm will call the eQSL page).

**Google Map** maps the home and distant QTHs. The way the other station is plotted is to use the coordinates for latitude and longitude from the cty.dat file unless the prefix of the distant station can be further resolved in the pfx.dat, in which case this position will be used.

Use of Google Map creates a file MixW2.kml in the default data directory and leaves a number of *callsign-(null).html* files in the appdata or application data local\temp folder.

The **Search** entry displays all previous QSOs with the callsign.

### Log Bar Layout

The Normal and Contest Layouts show a pre-chosen set of fields, while the Custom 1 and Custom 2 Layouts have all fields available. The widths of the Log columns are configurable. Place your cursor between two columns in the gray (title area), then click and drag to the desired width. Up to MixW2.18 to see additional fields in the Custom Layouts you must either hide some of the fields on the left side of the layout so that fields can move in on the right side of the layout or modify the Initialisation File. To hide a field drag the right side completely over the left side, decreasing the size to zero.

From MixW2.19 two files Custom1.dat and Custom2.dat are installed. These files contain a list of all the fields that can be displayed and are of this form:

```

1 MODE
2 FQRX
3 FQTX
4 DATE
5 TIME
6 CALL
7 RSTSNT
;8 EXCHSNT
9 RSTRCV
;10 EXCHRCV
14 DOM
11 NAME
12 QTH
;15 COUNTY
16 IOTA
17 MGR
13 NOTES
;18 ENDDATE
;19 ENDTIME
20 LOC

```

Lines which begin with ";" are ignored, so fields EXCHSNT, EXCHRCV, COUNTY, ENDDATE, and ENDTIME are absent in this example. You may change the order of lines (and according columns) but do

not change the numbering, i.e. CALL should always have 6 at the beginning.

**Note:** Before attempting to modify the Initialisation File make sure you have a working copy back up of the file.

Before starting to edit the Initialisation File make sure MixW is unloaded.

If using .csv log file format it is possible to configure the two preset layouts Normal and Contest and for MixW2.18 and earlier the two Custom layouts. The information is held in the [Initialisation File](#).

There are 4 headings in the initialisation file

[ContestBarLayout0] - Refers to the selection for the Normal layout  
[ContestBarLayout1] - Refers to the selection for the Contest layout  
[ContestBarLayout2] - Refers to the selection for the Custom 1 layout  
[ContestBarLayout3] - Refers to the selection for the Custom 2 layout

For MixW2.19 and later any attempt to modify the Layout2 and Layout 3 sections will be overwritten by the settings in the files Custom1.dat and Custom2.dat when MixW starts.

Each section consists of 40+ lines of information, not in any particular order. There are 5 keyword line types:

Lines= - Only one per entry. Leave this line alone  
Heightsx= - A number of entries. Leave these lines alone  
FieldWidthx= - Defines how wide the field is. Leave these lines alone.  
FieldAtColx= - Defines the field to be displayed at log bar column  $x+1$   
Fields= - Only one per entry. Defines the number of columns being displayed - 1

$x$  defines the log column position + 1.

**Note:**  $x$  value of 0 is a special case. If you modify it MixW will most probably not start or the log bar will be very corrupt. The only recovery is to restore the values to their originals or restore the back up copy of the initialisation file.

To modify the entries it is necessary to identify which column numbers + 1 are going to be affected. If insertions are being made identify the field numbers that are to be added. Use the Custom1.dat/Custom2.dat layout above, identify the field name(s) to be added then subtract 1 from the number in the left hand column (eg County is 14).

If columns are to be deleted subtract the number of columns to be deleted from the Fields= line. If the column(s) are the right most columns to be deleted no further action is needed. Otherwise starting at the FieldAtColx= where  $x$  is the column number - 1 and replace the value with the FieldAtColumn $x+1$ . This sequence has to be repeated until the last column value to be displayed has been updated e.g:

If displayed log column 7 is to be removed and there are currently 11 columns displayed change the line Fields=10 to Fields=9.

Now find the line FieldAtCol6= and replace the value after the = with the value after the = of line FieldAtCol7=. Now repeat for lines FieldAtCol7, FieldAtCol8, and FieldAtCol9. This has the effect of shifting the columns one place left.

This is repeated for each column removed.

To add columns at the right side of the log, note the value to the right of the Fields= line (value is  $n$  later in this sentence) and create or (if they already exist) modify the lines FieldWidth $n=40$  and FieldAtColumn $n=$  (the value after the = is the value identified by the column name to be displayed - 1.

Now add one to the Fields= value and repeat for any further columns to be added to the log bar.

To insert column(s) into the log bar, this is an example to insert the IOTA and Loc fields into the Normal log bar layout between the QTH and the RST\_Sent fields:

The Fields= value is 10 (Fields=10).

The RST\_Sent column is 9 (which translates to column 8).

Create, or modify (if they already exist) lines FieldWidth12=40 and FieldAtColumn12=12 (this is the notes field).

Create, or modify (if they already exist) lines FieldWidth11=40 and FieldAtColumn11=8 (this is the RST\_Recv field).

Modify line FieldAtColumn10=12 to FieldAtColumn10=6 this moves RST\_Sent

Modify line FieldAtColumn9=8 to FieldAtColumn9=15 this inserts the IOTA field

Modify line FieldAtColumn8=6 to FieldAtColumn8=19 this inserts the Loc field

Modify Fields=10 to Fields=12 (2 columns inserted).

Save the modified Initialisation File and start MixW. Once you have verified the changes are correct adjust the log column widths as required.

### **Making entries in the log.**

Entries may be typed directly into the log, by left clicking on the field, or they may be moved into the log from the RX window. Clicking/double clicking on data in the RX window will copy it into the Call, Name, LOC, RST\_Recv, Notes or Exchange Received field in contest mode field in the log depending on the configuration of the word.

For Roundtable operation, a second, third, etc. call may be appended to the Call window by copy and paste from the RX window, and separating the calls with commas. If this is done, all macros using the <CALL> macro will also use the additional calls.

Holding the CTRL key and clicking/double-clicking on a word will **append** that word to the QTH box. By holding down CTRL and clicking/double-clicking each word of a QTH in turn, a multi-word QTH can be entered into the log without typing.

Holding the ALT key and clicking/double-clicking on a word will append that word to the NOTES box. By holding down ALT and clicking/double clicking each required word in turn the information can be entered into the log without typing.

**Note:** The Click/Double Click option can be selected from the Options|Click menu item. I prefer double click since accidentally single clicking in the RX window can change the QSO data unintentionally.

All log entries can also be filled in by highlighting the information on the screen, holding down the left mouse button, "dragging" the information into the desired box, and releasing the mouse button.

A log entry may also be filled in by highlighting the information, pressing the right mouse button, and copying and pasting the information into the desired box, or choosing a location from the displayed menu. This method can be used to capture a call with imbedded spaces such as "K E 6J"

This is the menu for early MixW releases.

Half Moon Bay

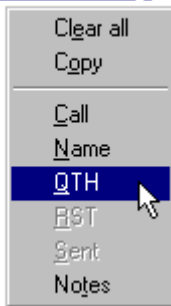

MixW3.1 menu.

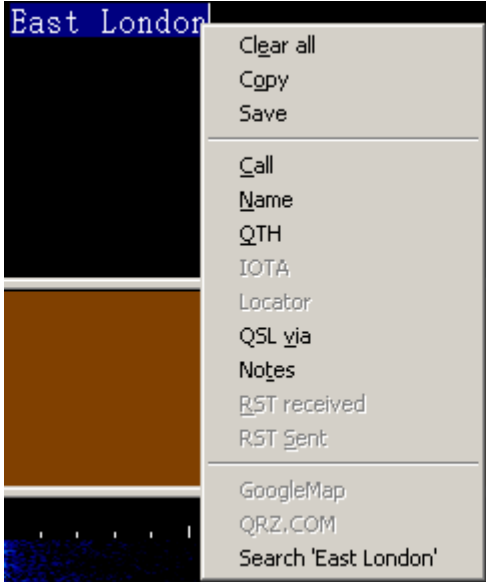

The Save function saves the highlighted data to a disc file located in the default data directory with a name of the format shYYMMDDHHMISS.txt

When the desired entries are filled in, clicking the Save icon button will save the information into the log. You can also use the <SAVEQSO> macro at the end of your sign off macro to automatically save the QSO to your log. By clicking the Search icon button you can search the log for any character or string of characters by typing a string to be found and clicking the Search button on the search dialog. You can also display the entire contents of the log by clicking the "Display Whole Log" button.

**Note:** If you select a new callsign in the RX window before you have saved your QSO information, your "New" QSO line will be cleared and the new call inserted. To avoid the possibility of accidentally losing a QSO this way, UNcheck "Clear QSO on new call" under the Options menu, then a new call will not clear the unsaved QSO. You can also restore an accidentally cleared or deleted QSO by selecting File | Restore removed QSO.

### Changing or Editing a QSO

To add data in fields not displayed by the Log Bar or to add or modify previously saved data for a QSO select one of the Edit methods for the QSO as detailed above.

This will bring up the Edit QSO dialogue. Make any changes you need and click OK to save the data.

**Edit QSO**

Start date & time: 21/08/2011 10:26:30

End date & time: 21/08/2011 10:28:50

FqRx: 10141.985 kHz Your call: 2E0BPP

FqTx: 10141.983 kHz Mode: BPSK63

Call: DK0DAN/LH QTH: Knock

Name: Dieter Domain: County:

Manager: IOTA: Loc.: JQ33mi

RST sent: 599 rcvcd: 599 Exch sent: recvd:

Custom:

Notes: #LH FED-128 (DJ8DS)

QSL msg: Hpe cuagn Dieter.

Q  Sent Norway (LA)  
 S CQ zone: 14  
 L  Rcvd ITU zone: 18

eQSL:  Sent  Rcvd

**Change country**

Call: DK0DAN/LH

Country:

Norway

**Add new call area**

Callsign or mask: DK0DAN/LH

Prefix: LA Norway

CQ zone: 14

ITU zone: 18 Time zone (hours): -1

Continent: EU Lat: 61 Long: 9

This area name: Norway

There are instances where other data pertaining to the QSO may need to be changed.

In the example above the /LH suffix causes MixW to log this QSO for Norway although the /LH suffix is to indicate a Lighthouse. To correct this use the Change button in the Edit QSO dialogue. This will bring up the Change country dialogue. Either use the drop down menu to select the prefix of the country you wish this QSO to be associated with or just enter the prefix if you know it. By entering DL in the Country box the line below will change to Fed. Rep. of Germany. If this is all you need click OK. The new prefix will be saved in the DxPfx field of the log. If this QSO is selected again in the future the Country will now be shown as Fed. Rep. of Germany and not Norway. However if a new QSO with this call is made it will show the country as Norway unless a new rule is generated.

To create a new rule click on Change rule in the Change country dialogue. This will now bring up the Add new call area dialogue. Change the Prefix to the one you are creating the new rule for (it is the same as for the Change country). This will now change the other data to the data for this prefix in cty.dat. If desired more accurate latitude and longitude can be entered and zones and timezone corrected. Click Add. A messagebox informing pfx.dat has been updated will appear. Click OK. Now whenever the callsign is entered in the log the New rule data will be displayed.

### When to use Change Country and Change Rule

cty.dat is regularly updated. One of the items it documents are dxpeditions and temporary callsigns. This is OK whilst the callsign is in the cty.dat file but certain countries and political areas make changes to calls, reissue callsigns etc. Two examples are the USA where calls for expeditions are recycled and the UK where the prefix GB can be used in any of the G prefix areas and some callsigns are associated with exhibitions that move around the UK.

Where a callsign is likely to be reused a new rule should not be used. However where a change is permanent (eg A prefix change that may be reflected as a new country in cty.dat) then a new rule should be created.

When MixW indicates it has updated pfx.dat the new data is inserted at the bottom of the file.

### Printing and Exporting your log file.

First select the QSO's you want to print by clicking on the Search button in the Log Bar, which will bring up the "Search in Logfile" dialog:



The screenshot shows a dialog box titled "Search in logfile" with a butterfly icon in the top-left corner. The dialog contains several search criteria, each with a checkbox and a dropdown menu or text field. The criteria are: "Text" (checkbox), "Band" (160m dropdown), "From" (05/07/03 02:30:18 P dropdown), "To" (05/07/03 02:30:18 P dropdown), "QSL snt" (NO dropdown), "QSL rcv" (NO dropdown), "Contest" (empty dropdown), "Your call" (KGIX dropdown), "Mode" (MFSK dropdown), "Country" (UR dropdown), and "Continent" (EU dropdown). There are also buttons for "Display", "Cancel", and "Whole log".

You can now display the whole log by clicking the **Whole Log** button, or search for particular groups of entries by selecting the fields to be searched, along with the search criteria, and clicking the **Display** button. The following window will be opened to show the records that were found:



UTC start	UTC end	RX kHz	TX kHz	Mode	Call	Sent	Rcvd	Name
05/06/03 18:29:04	05/06/03 18:29:41	14069...	14069...	BPSK...	K6CNV	599	599	Jeff
05/07/03 00:30:38	05/07/03 00:36:56	14069...	14069...	BPSK...	K6IX	599	599	Scott

Buttons at the bottom: Edit, Delete, to Text, to CSV, to Cabrillo, to ADIF, Statistics, Callbook, Print, Close.

The fields in the Search Results window can be resized in the same way as the Log Bar so that you can see the fields you are interested in. Select the records you want using standard Windows functions such as Click, Shift-Click, and CTRL-Click. To select all the records displayed in the log select a single log entry, right click on it select Select All from the drop down menu. All displayed records are now highlighted. Use the buttons at the bottom of the window to print or export the records you have selected. You can also Edit or Delete log entries, look up contacts in the Callbook, or display statistics from the selected entries.

The log for MixW V3.1 has been enhanced.

UTC start ▲	UTC end	RX kHz	TX kHz	Mode	Call	Sent	Rcvd	Name	QTH	Dom
06/06/2009 11:05:09	06/06/2009 11:06...	14075...	14075...	HELL	UT2UZ	599	599			
06/06/2009 11:10:31	06/06/2009 11:11...	14078...	14078...	MFSK	UT2UZ	599	599			
06/06/2009 11:16:17	06/06/2009 11:16...	14078...	14078...	RTTY	UT2UZ	599	599			
06/06/2009 20:12:43	06/06/2009 20:13...	14075...	14075...	BPSK...	UT2UZ	599	599			
06/06/2009 21:24:35	06/06/2009 21:25...	7039...	7039...	BPSK...	UT2UZ	599	599			
07/06/2009 14:53:01	07/06/2009 14:54...	14077...	14077...	OLIVIA	UT2UZ	599	599			
26/09/2009 06:26:14	26/09/2009 06:26...	7058...	7058...	RTTY	UT2UZ	599	599			

Buttons at the bottom: Edit, Delete, to Text, to CSV, to Cabrillo, to ADIF, Statistics, Callbook, Add, Refine, Print, Close.

Left clicking on the column title bars will cause MixW to sort the log entries numerically on the data in the selected column. Appended to the column heading is a small arrow indicating if the column is sorted in ascending or descending order. Two additional buttons are now displayed. Refine does not appear to be implemented but Add allows the build up of multiple searches.

### Sending an eQSL card

You must be registered with eQSL ([www.eqsl.cc](http://www.eqsl.cc)) and have a valid password. The computer must be on-line, but you do NOT need to be signed in to eQSL. Select the log entry you want to QSL in the Log Bar and click the QSO Details button, or in the Search Results window click the Edit button. This will bring

up the Edit QSO window. Make any changes or additions you want and click the Send eQSL! button. You will be asked for your password, and then a window will be displayed showing the status of your eQSL. Click the eQSL sent box before closing the Edit QSO window.

If you want to send a batch of selected qsl-records, you just "right click" the mouse in the highlighted (selected) area of the MixW log file "Search results" window. A new menu now appears, where you choose "Send QSL(s) to eQSL.cc". The whole batch of qsl's is then transmitted to the eQSL database.

You can also send eQSL's by exporting selected records to an ADIF file and uploading that file to eQSL.

### **Using the MixW program to create a QSL card to print or to email.**

The MixW program provides a dynamic data exchange ([DDE](#)) link for use by other Windows programs such as MS Word and Excel or OpenOffice Writer. The data that is available can be used to create a QSL card by inserting DDE fields into a document that will be viewed as a QSL card in the final form. To learn more about DDE fields, go to the HELP files in your application that supports Windows DDE fields. The chart below shows a subset of the DDE code fields supported by MixW:

<u>Entity</u>	<u>Server Name</u>	<u>Topic</u>	<u>Item</u>	<u>Current state</u>
Your call	MixW	Info	MyCall	K4SET
Your name	MixW	Info	MyName	Scott
Your QTH	MixW	Info	MyQth	Murray, KY
Program name	MixW	Info	Program	MixW
MixW version	MixW	Info	Version	2.0 beta 21
QSO date	MixW	QSO	Date	28-Jan-2001
QSO time	MixW	QSO	Time	20:57
Frequency, MHz	MixW	QSO	Mhz	14.1
Mode	MixW	QSO	Mode	BPSK31
Call	MixW	QSO	Call	W8HAT
Name	MixW	QSO	Name	RICHARD
QTH	MixW	QSO	Qth	STEVENSVILLE MI
RST sent	MixW	QSO	RstSnt	589
RST received	MixW	QSO	RstRcv	589
Notes	MixW	QSO	Notes	Likes to fish
QSO is unsaved	MixW	QSO	Changed	NO
QSO freq.	MixW	QSO	Khz	14070

To use these field codes in a QSL or for making mailing labels, you enter the field code in the document where you want it to appear.

**For MS Word** you can add a DDE field by using Ctrl-F9, then fill in the field code. To view the results in the final form, use F9. To view the field position the cursor over the field and use Alt-F9.

From the chart above, you would create "your call" with the following string of field code:  
{DDEAuto "MixW" "Info" "MyCall" \ \*MERGEFORMAT}

The following describes how to create a QSL card with MixW V2 or V3 using the MS Word form provided with the program:

Step 1. Open the log entry that you wish to use for the QSL card. Either select the log entry from the MixW log window or use the Search feature to find it and then open it in the Edit QSO window.

Step 2. Make sure all the desired log entry fields for the QSL are entered into the log. Leave the log entry open while completing the remaining steps.

Step 3. Find the "MixW QSL card test.doc" file in the MixW folder and open it in the MS Word program.

Step 4. Use the MS Word print function and your color printer to create a hard copy of the QSL card.

**For OpenOffice Writer** I would suggest updating to Open Office V3.3 or later. I have experienced problems trying to use DDE with Open Office V3.1

For OpenOffice 3.3 start MixW and select the QSO you want to create the QSL for. Next open MixW QSL card test.doc with OpenOffice.org writer.

Highlight and delete the large call field then press Ctrl-F2 or select menu item Insert|Fields|Other:

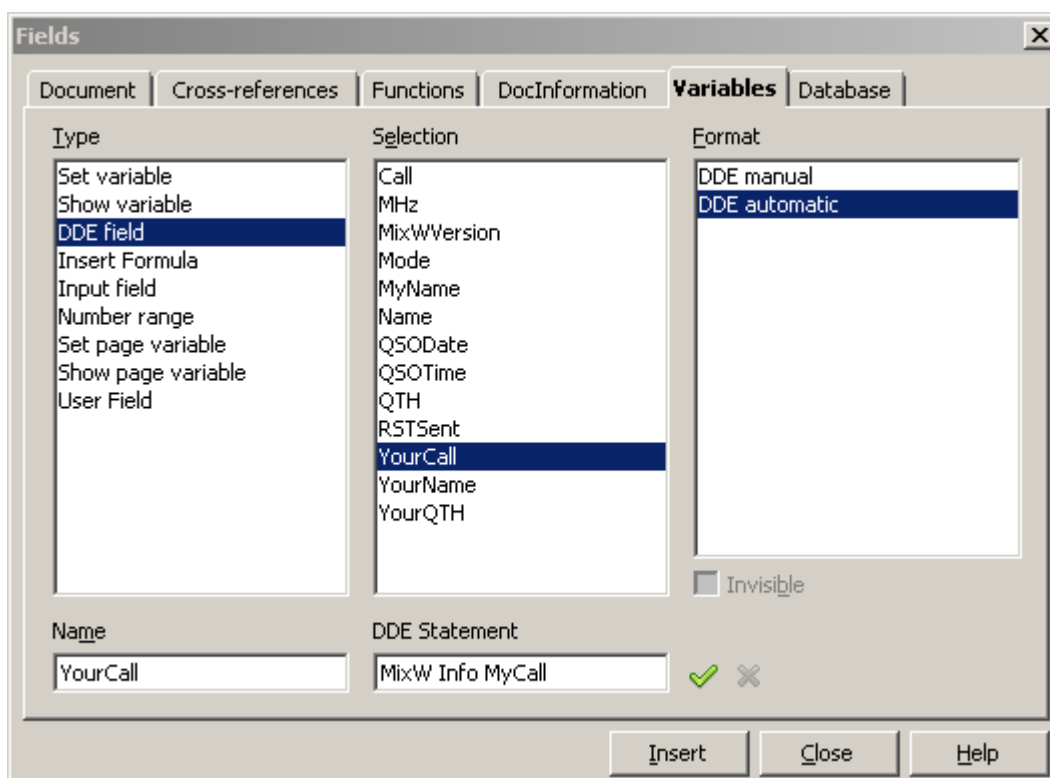

Select tab Variables, then under Type select DDE field and under Format select DDE automatic.

Fill in the Name with YourCall and the DDE Statement MixW Info MyCall. Now click on the small green tick to the right of the DDE Statement box, which will put the entry into Selection, then click on Insert. This will now insert your call in the card. Repeat this for each of the other fields in the card. You do not need to close the fields selection box between fields.

Save this document in .odt format.

**The following will describe how to create a graphical file of the QSL to attach to an email:**

Step 1. Create the QSL card as above.

Step 2. Select (highlight) the entire QSL card by Edit | Select All, from the tool bar.

Step 3. Copy the QSL card by Edit | Copy, from the tool bar.

Step 4. Open your favorite graphics editor (like Paint Shop Pro) and then Paste the QSL card into the editor by Edit | Paste as New Image. (Note, Paint shop Pro is still available from the Internet.)

Step 5. Save the QSL card as a .gif file by File | Save as | CompuServe GIF file. Save it to a directory where you can retrieve it later as an attachment file to your out-going email.

## Save Files

---

The first time MixW is activated after installation various parameters are set up via the menu system. MixW saves these parameters and accesses them each time it runs. Whilst running MixW other changes may occur the operator is not aware of. These changes maybe saved by MixW.

**For security these files should be saved** to enable an inoperable MixW setup to be restored quickly.

### Files to save

- Backup.pwd - (created if the MixW log archive has been used).
- Bands.ini - (helps control the Rig frequency/Mode)
- Cty.dat - (Contest prefix file)
- Custom1.dat - (Modified to give alternate
- Custom2.dat Log file layouts)
- \*eqsl.ini - (if MixW used to send qso information to eQSL.cc)
- \*Events.dat - (Saves schedule event settings)
- Icons.cfg - (Selects icons display keywords)
- Knownfqqs.dat - (Marks known frequencies on the waterfall/spectrum display)
- lang.ini - (used with LANG\_ macros)
- \*Mixcontests.ini - (Contest list)
- \*Mixmacros.ini - (Default macros)
- \*MixW2.ini - (MixW initialisation parameters)
- \*MixW2.log - (Default file name/format that stores QSO information)
- MixWReg1.dll - Registration file for MixWV2.19 and earlier
- \*qslprint.ini - (qslprint.exe initialisation file)
- \*pfx.dat - (Information about prefixes)
- Winkey.ini - (WinKeyer initialisation file)
  
- \*All .mc files - (Other macro files)

.pal files - (Waterfall palette files)

Any other files changed by yourself

**Note:** Files marked \* can be changed by MixW software.

## Archiving

Archiving maybe achieved by a number of methods:

- Windows archiving using the a (archiving) file flag
- 3rd party software package run at a preset time.
- 3rd party software run after MixW is terminated.
- Facilities within MixW.
- Under control of a Windows script. User selects runtime.
- Same Windows script run at MixW exit time.

Windows archiving and use of 3rd party software is outside the scope of this file.

## MixW backup options

The MixW menus and log facility only provide a back up service for the log file.

By using the eQSL.cc logging (see [eQSL](#)) eQSL can provide a back up of QSO data. eQSL provides a download of the outbox. How long this will take to restore data is not known and the data saved (and thus available for restore) is fairly limited. Callsign, date, time, band, mode and rst sent are available.

MixW has 3 save formats available from the log display:

- to Text
- to CSV
- to ADIF

To use any of these 3 methods the log file must be displayed (see [Exporting your log file](#))

From MixW Version 2.2 a back up and restore log feature is provided by MixW, the users log file is saved in ADIF file format on a server in the Ukraine. This log file can be password protected. The user enters the password in the file backup.pwd.

## Windows Batch File Script

Microsoft supplies a simple script language as part of the MSDos installation, present in all Windows installations.

**Note:** this is not intended as a tutorial. For more information open a CMD (MSDos) window and type help for a list of available commands. Type help commandname for help with that command.

Commands can be input into text files with the suffix .bat:

```
filename - logcopy.bat
contents - copy mixw2.log thebackuplocation
```

or executed in an MSDos window.

When the command copy mixw2.log *thebackuplocation*, or logcopy.bat is executed this command will

attempt to copy the default MixW log file to the directory *thebackuplocation*.

If the copy fails a message will be output. This message can be read if the copy command was executed from a CMD window or the .bat file it is in was executed from a CMD window. However if the copy command fails whilst it is being executed as a part of a back up macro within MixW there is every chance the window that displays the error will be closed before the message can be read.

A .bat file can be created that can be executed from within MixW at exit time or by double clicking on the .bat file name using Windows/File Explorer at any other time.

In the following script any line that starts with REM is a REMark, either an explanation or comment and can safely be deleted from the working script.

**Note:** this script has been modified from the original script included in the August 2013 Help Files following the diagnosis of two problems.

This script assumes MixW has been installed using the default settings

A further change has been introduced to select, via a message box, if the back up is to be taken or not. When MixW is being stopped and started at short intervals for an investigation, or checking changes to files there is no point in taking the back up every time.

The basic script:

```
@echo off
```

```
REM To introduce an option to make the back up or not remove the REM from the next three lines.
```

```
REM echo wscript.quit msgbox("Execute Back Up?",36,"BackUp") >dobackup.vbs
```

```
REM WSCRIPT //NOLOGO dobackup.vbs
```

```
REM if %ERRORLEVEL% NEQ 6 goto CJBEX
```

```
setlocal
```

```
set MSGABORT=Use Ctrl-C to abort the copy. Any other key ignores this file and continues.
```

```
REM Set up the housekeeping counters and make sure the files list file is deleted.
```

```
REM The value in RCNT is the count of the number of backup directories to keep.
```

```
REM I use 28 which, with me sometimes starting and stopping MixW more than once
```

```
REM in a day gives me 18 or 19 days backup.
```

```
set RCNT=28
```

```
set bcnt=0
```

```
set BDNM=bupdirs.txt
```

```
if exist %BDNM% del %BDNM%
```

```
REM Form date
```

```
REM I normally use a date of YYYYMMDDHHMI as Windows
```

```
REM sorts them by earliest date first
```

```
for /f "Tokens=1-3 delims=/ " %%A in ('date /t') do set SFX1=%%C%%B%%A
```

```
for /f "Tokens=1-2 delims=: " %%D in ('time /t') do set SFX=%%SFX1%%D%%E
```

```
REM If separator characters are preferred (eg YYYY-MM-DD_HH-MI) set the two lines above to be:
```

```
REM for /f "Tokens=1-3 delims=/ " %%A in ('date /t') do set SFX1=%%C-%%B-%%A
```

```
REM for /f "Tokens=1-2 delims=: " %%D in ('time /t') do set SFX=%%SFX1%%_%%D-%%E
```

REM Make the backup directory. The backup directory can be  
REM a full path name to any directory name addressable by windows  
REM or a directory in the current MixW data directory.

REM The quotes around backup are only necessary if there are spaces in the  
REM directory name. They can be safely left there if there are no spaces in the name.  
REM Change the instances of backup in the next five lines to your back up path\directory.

if not exist "backup" MD "backup"

REM Now count the number of backups made  
for /f %%A in ('dir /b "backup"') do call :XCNT %%A

REM If necessary reduce the number of backups  
for /f %%B in (%BDNM%) do call :RDIR %%B

MD "backup\%SFX%"

REM No quote marks needed on this line  
set BUPD=backup\%SFX%\

REM First do the .mc files

REM -----  
if exist \*.mc for /f "delims=" %%Q in ('dir /b \*.mc') do CALL :FILECOPY "%%Q"

REM Now the .dat files

REM -----  
if exist \*.dat for /f "delims=" %%S in ('dir /b \*.dat') do CALL :FILECOPY "%%S"

REM The .pal files (palette files)

REM -----  
if exist \*.pal for /f "delims=" %%W in ('dir /b \*.pal') do CALL :FILECOPY "%%W"

REM The .ini files

REM -----  
if exist \*.ini for /f "delims=" %%X in ('dir /b \*.ini') do CALL :FILECOPY "%%X"

REM Finally any other files you think need backing up

REM Save the backup script in case changes have been made

REM call :FILECOPY Your script filename.bat

call :FILECOPY Backup.bat

REM Do the log file last

call :FILECOPY Mixw2.log

REM Everything completed. Exit the script

goto CJBEY

```

REM Part of the housekeeping.
REM This routine counts the number of back up copies made
REM and saves the back up names
:XCNT
echo %1>>%BDNM%
set /A bcnt=%bcnt%+1
goto CJBEX

REM This routine deletes the backup directories earliest first.
:RDIR
if %RCNT% LSS %bcnt% rd /s /q "backup\%1"&set /A bcnt=%bcnt%-1
goto CJBEX

REM End of the housekeeping routines

REM This is the copy routine
REM FILECOPY copies a file from parameter 1 to backup
REM Any fails get reported. One retry copy of the failed file
REM maybe attempted.

:FILECOPY

REM Check file is present
REM No need to go any further if the file cannot be accessed

if exist %1 goto FILEOK
echo Unable to find file %~1
echo %MSGABORT%
PAUSE
goto CJBEX

REM Execute the copy

:FILEOK
copy %1 "%BUPD%">NUL
if %ERRORLEVEL% EQU 0 echo File %~1 copied OK&goto CJBEX
echo File copy of %~1 failed.
echo Press any key to retry the copy. Use Ctrl-c to abort the copy script.
pause
copy %1 "%BUPD%">NUL
if %ERRORLEVEL% EQU 0 echo File %~1 copied at 2nd attempt&goto CJBEX
echo 2nd attempt. File copy of %~1 failed.
echo %MSGABORT%
pause
goto CJBEX

REM Script exit point

:CJBEY

REM Delete the backup file list
if exist %BDNM% del %BDNM%

endlocal

```



REM If you want to see the result of the copies include the following two lines

REM echo End of Backup

REM pause

REM FILECOPY routine exit point

:CJBEX

Any copy fails will be reported to the screen and the copy paused. A retry of the copy is offered and if the copy fails a second time an abort script option is offered. If no fails are detected the window will close automatically.

Each backup is kept in its own directory so housekeeping will be necessary to prevent a large build up of backup directories.

An added bonus is all the 'tuning' files for the MixW installation are extracted so a new MixW installation can have as many of the last archive files as is necessary copied to it.

Assuming this script is written to a file backup.bat located in the MixW data directory to execute this back up at MixW exit time:

[Create a macro](#) (or add the EXEC command as the last entry) OnEndMixw <EXEC:backup.bat>

## **\*DIGITAL MODES**

---

CW

FAX

RTTY

Amtor

Packet

Pactor

PSK

MFSK

THROB

FSK

MT63

SSTV

Hellschreiber

Olivia

Contestia

RTTYM

**CW**

---

**CW Introduction and Theory**

**CW Operation**

**CW Intro & Theory**

---

**With thanks to Steven R. Hurst, KA7NOC**

### **CW and Morse Code.**

CW stands for "continuous wave", but when hams use the term today they are referring to the use of the International Morse Code to communicate with a series of on and off pulses of a single RF frequency.

Morse code is named after Samuel F.B. Morse, 1791-1872. The code consists of a series of dots and dashes. Each letter of the alphabet and numbers 0 through 9 have individual combinations assigned to them. For example, the letter "E", is a single "dit" making it the easiest letter to learn and send. Some people can copy code at speeds of up to 70 words per minute, but most hams copy in the 10 to 30 words per minute range. Once you get over the learning curve, Morse code becomes a second language, and you

begin to hear "words", not just individual letters. You begin to recognize the rhythm of the words so you can easily pick them out and follow along with the conversation.

Beginning hams usually send CW with a "straight" or hand key and copy each letter and word of a QSO as they hear it on their receiver. If they enjoy CW they may graduate to sending with a semi-automatic "bug", or use paddles and an electronic keyer for fully automatic dots and dashes.

### **CW as a computerized digital mode.**

With a program such as MixW, CW can be sent and received using the keyboard and the computer screen, just as is done with the more recent digital modes. MixW will copy computer-generated code nearly without error. It will also copy code sent well with an Iambic paddle and electronic keyer, so long as the timing is good. It can even accommodate small variations if the user is adept at picking out the good copy from the bad on the screen. Most code sent by hand, however, is simply not printable by computer. The timing is just not consistent enough for the computer to understand. In these situations being able to copy the code by ear will help supplement the code that the computer copies for you.

Sending CW from the keyboard is particularly valuable for individuals who have a physical impairment and can no longer use a key or paddles, but still love to operate CW and can copy the code at high speeds in their heads.

## **CW Operation**

---

### **Configuration**

There are six different methods for operating CW with MixW.

1. Sending and receiving with the soundcard (while the transceiver is in SSB mode)
2. Manual sending and receiving (while the transceiver is in CW mode).
3. Keying your transceiver with a key plugged into the computer, which is similar to the way MixW handles the PTT signal for the other modes (your transceiver is in CW mode)
4. Using a CAT command to your transceiver (your transceiver is in CW mode).
5. Using a dedicated hardware multimode TNC for both decoding and encoding of CW via the TNC (your transceiver is in CW mode).
6. Using a WinKeyer (your transceiver is in CW mode .

**SoundCard approach:** The soundcard approach to CW operation is the simplest to implement. In this approach, your transceiver is in SSB mode (either USB or LSB will work). Configuring MixW to use the SoundCard approach is the same as with the other digital modes. First select Configure | TRCVR CAT/PTT... and check "CW out via soundcard". Next, select Mode | CW, and then select Mode | Mode Settings... and choose an RX Algorithm. Then you can select your RX and TX frequency by clicking in the waterfall, and transmit by typing into the TX pane and clicking the RX button in the Status Bar. Your rig is switched to TX with VOX, PTT, or CAT, just as it is for any other mode.

**Manual Sending and Receiving:** In the manual mode you only use MixW as a tuning and logging program. Select Configure | TRCVR CAT/PTT... and UNCHECK "CW out via soundcard". Then choose Mode | Mode Settings, and select Manual from the RX Algorithm selections. Plug your key into your transceiver, and set the transceiver to CW mode. Now the frequency of the CW transmission is set by the transceiver, so MixW will lock the TX on the waterfall and display the red flag there. You can set the RX frequency wherever you want since you will be decoding by ear. With the RX Algorithm set to manual you can type into the RX pane and use MixW's logging features. You must tune with the transceiver, but watching the waterfall will help you set your TX frequency right on top of the station you are answering.

**Direct CW keying:** In this method MixW directly keys your transceiver via a connection between your

computer's COM port and your transceiver's key input (a [PTT](#) type circuit is used for this connection). This works in the same way as connecting any external keyer to your transceiver, the only difference is that MixW (and your computer) are acting as the external keyer. In this case your transceiver is operated in the CW mode, and you truly are sending CW. You then have full advantages of your transceiver's CW filters etc.

**CAT operation:** If you are already triggering PTT via the CAT control options of MixW, this may be your best option for keying CW as well. To implement direct CAT operation for CW select Configure | TRCVR CAT/PTT. Check the box to use the "CW via CAT command" option, and make sure your Com port and rig settings are correct. You can also adjust for correction in your frequency reading for the CW mode by using the "Cat correction in Hz" box for CW. For more information on these settings see the Configuration topic. Now when you set MixW for the CW mode, it will automatically switch your rig to the CW mode and trigger CW keying through CAT as well as adjust your frequency standard according to these settings.

### CW via a Hardware TNC:

See [TNC Configuration and operation](#) topic to use MixW with a hardware TNC for CW operations.>

### CW using a WinKeyer:

See [Configure the WinKey Port](#) topic to use MixW with a a WinKeyer Device.>

## Operating CW (using the soundcard)

First, switch to the CW mode by selecting Mode|CW, or clicking on the mode box in the Status Bar and selecting CW. Next set your CW settings by selecting Mode|Mode settings. This will bring up the following CW settings dialog box:

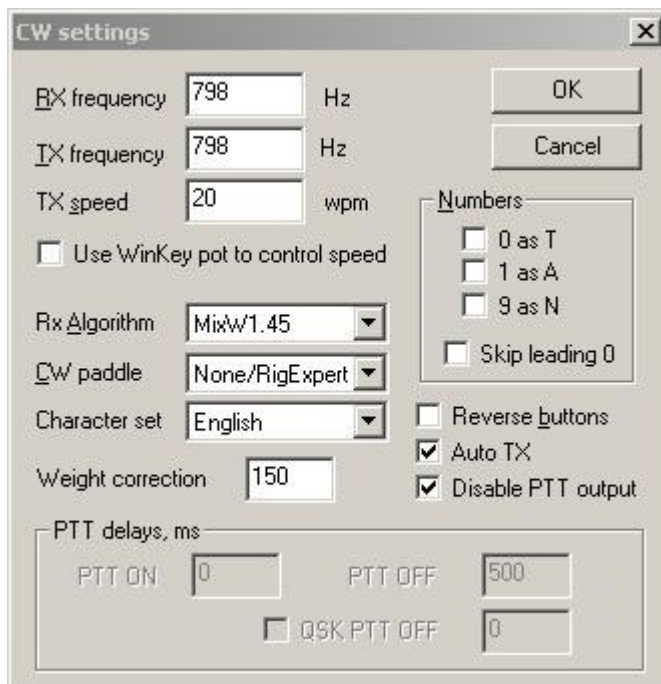

Here the TX and RX frequencies are displayed and can be changed, although it is much easier to change them by clicking in the spectrum/waterfall window.

You can also tell MixW to convert your 0, 1, and 9s to letters as indicated by checking these boxes.

**CW Speed:** You can set the sending speed in the CW settings dialog box, although this is more easily adjusted by clicking in the speed display which automatically loads with the CW mode.



**Note:** The speed adjustment is for sending speed only. MixW automatically detects the RX speed and adjusts accordingly, but it will send at whatever speed is indicated on the CW speed box.

Speed change may also be achieved by the use of the [Macro <WPM>](#)

### Temporary Sending Speed Adjustment

If using MixW to directly send data to the transceiver (i.e. not through a keyer) any of the following two character sequence inserted in the TX data stream will cause the sending speed to change as indicated until either another sequence is received or the transmit is ended.

- ~^ - Adjust by +5wpm
- ~v - Adjust by -5wpm
- ~0 - Set speed to 16wpm
- ~1 - Set speed to 20wpm
- ~2 - Set speed to 24wpm
- ~3 - Set speed to 27wpm
- ~4 - Set speed to 30wpm
- ~5 - Set speed to 34wpm
- ~6 - Set speed to 37wpm
- ~7 - Set speed to 40wpm
- ~8 - Set speed to 50wpm
- ~9 - Set speed to 60wpm

The data to transmit is:

<TX> <CALL> ~^~^<RSTS>~v~v <NRS> <NRS><RXC>

will send the CALL at the indicated wpm, increase speed by 10wpm, send the RST decrease the speed by 10wpm (back to the original speed) and send a contest exchange.

**Receive:** To receive CW tune to one of the CW sub-bands and listen for CW signals while watching the spectrum/waterfall display. Click on one of the signals as indicated here in the waterfall display, and you should start seeing text appear in the RX window:



You will notice in this picture that while the letters are being decoded accurately, the timing of the characters being sent is such there are spaces between each one. It is important to note that accurate CW decoding, whether by hardware or software TNCs, is difficult to achieve due to the lack of timing standards with CW operations. Computer generated CW is the easiest to decode accurately in software, but even this is a challenge (as you can see above) because timing parameters vary between the different software packages and user settings. You will notice quite a few missed characters while trying to decode

some hand sent CW, especially from a straight key.

**Transmit:** To switch between Transmit and Receive click on the TX/RX box in the status bar. For additional information on general operating procedures see the General Operation topic.

As with most of the other digital modes, It is possible to open multiple RX windows and switch the active window (the one you will be sending to) between them. For this and other general operation techniques see the General Operation topic.

**Other hardware options.**

MixW is capable of using a Joy Stick port or a Parallel port for CW key or keyer input. The following diagram shows how to wire these ports:

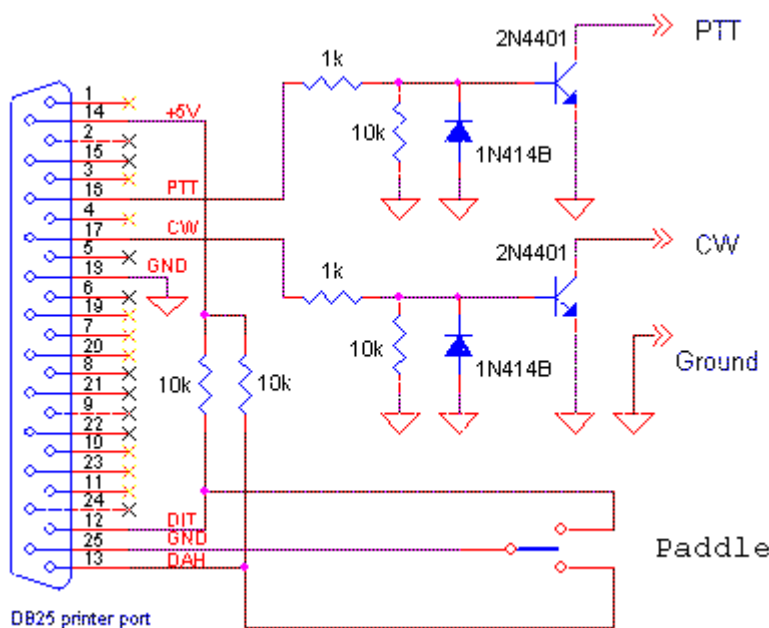
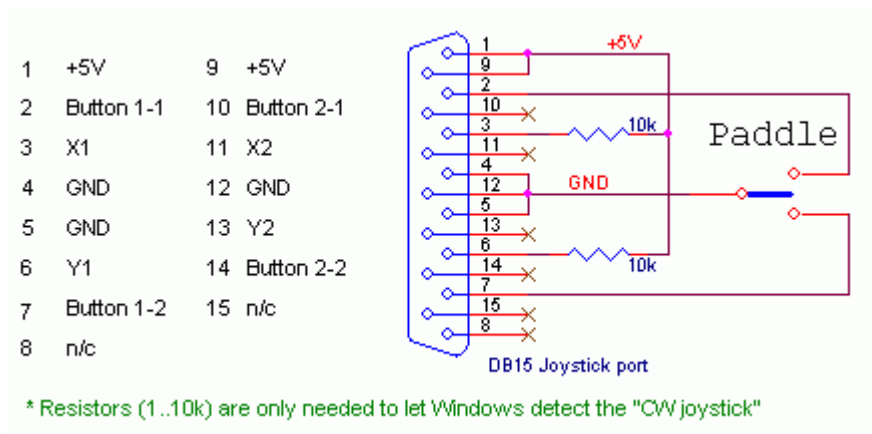

**FAX**

**FAX Receiving**

**FAX Receiving**

For information on HF FAX stations and some theory of operation visit:

[http://www.hffax.de/html/hauptteil\\_hffax\\_listings.htm](http://www.hffax.de/html/hauptteil_hffax_listings.htm)

MixW supports FAX receive only. The following procedures will help you get started receiving FAXes.

Your transceiver should be set to USB and tuned to one of the frequencies of the FAX stations listed at the website shown above.

[Calibrate your sound card.](#)

Toggle all the toolbars off by selecting View and then uncheck the various toolbars to get a larger viewing window for your incoming FAXes.

Select Mode | FAX,, then select Mode | Mode settings to bring up the settings dialog box:

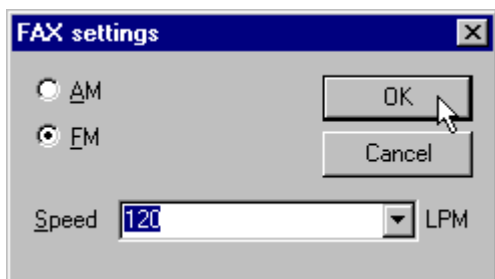

Most Weather fax is 120 LPM in FM mode.

**To print** a received FAX use a screen capture program or press the Print Screen button on the computer keyboard to save the screen to the Windows clipboard. Then you can paste the picture into Microsoft Paint or a graphics program.

The following picture shows the display of a properly tuned WX FAX station:

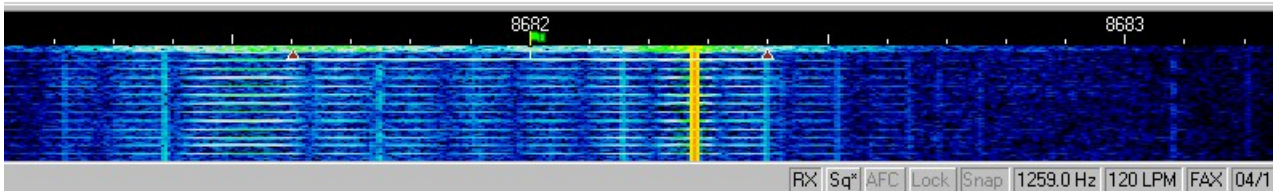
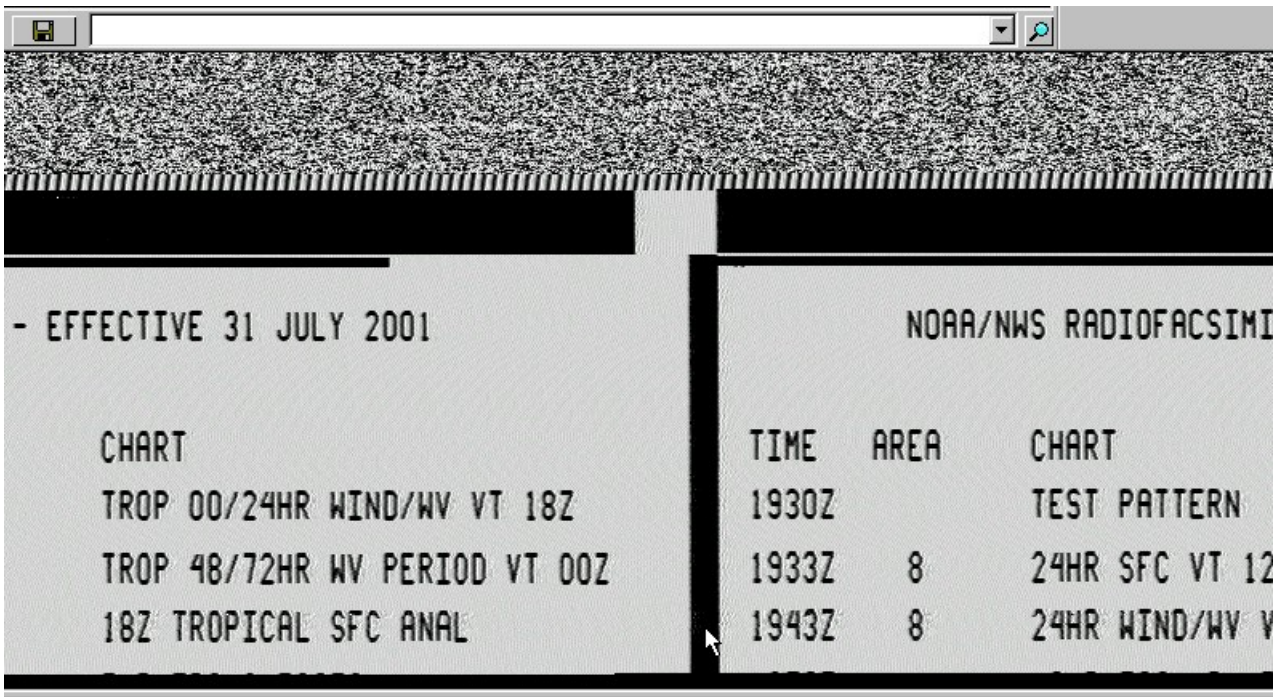

Notice that the picture being received is not alligned properly--it is split in the center. To correct a misaligned picture click on the vertical line in the picture that you want to be the new left hand edge (note the position of the mouse pointer in the illustration above). MixW will then realign the picture as shown here:



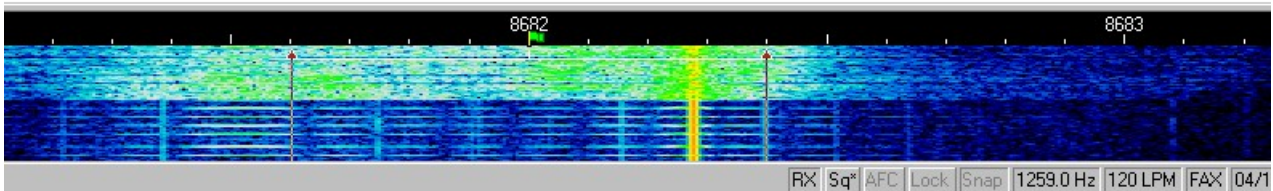
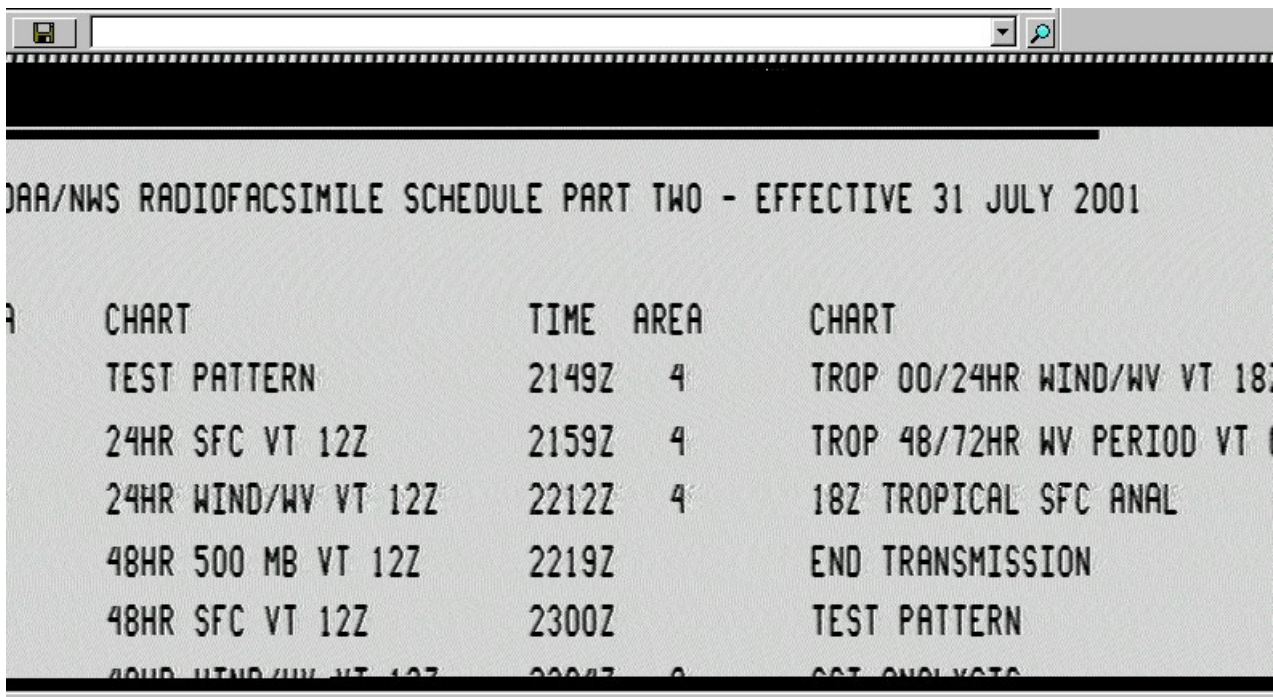

## RTTY

---

### RTTY Introduction and Theory

### RTTY Operation

## RTTY Intro & Theory

---

**From the website of Richard B. Griffin, NB6Z**

RTTY or RadioTeletype is a direct machine-to-machine communications mode using the Baudot (or Murray) code. This mode became popular with many amateurs when surplus TTY machines became available at a reasonable cost after World War II. These mechanical monsters provided a keyboard for Input and a paper roll for printed Output. They were also useful to help hold the house down in times of hurricane winds - they must weigh a ton. Video displays were still too exotic and expensive in those days. It was not until the mid 1970s that we began to see the Video Display come into more widespread use. (By the way, have you ever wondered why early Program Languages like BASIC use the command PRINT to display their output?)

When transmitting Morse Code, the transmitter is switched on and off to make the dits and dahs. When sending Teletype however the transmitter runs continuously, sending either of two frequencies

conventionally known as Mark and Space (a reference to paper tape reception of telegraphy). The early pioneers found on-off keying was not all that successful for Teletype signals because of interference from static.

They experimented with FSK, or Frequency Shift Keying and found it performed much better. With FSK, the transmitter is shifted up in frequency every time a Mark is to be sent, reverting to the lower frequency for a Space. The amount of the shift is usually 170 Hz for Amateur Radio use although many commercial Teletype signals use other shifts, notably 425 Hz and 850 Hz. Many systems use AFSK or Audio Frequency Shift Keying. When this is sent, the transmitting station generates the Mark and Space audio tones and feeds them into the transmitter's microphone input. The result at the receiving end is that the same audio tones are heard and processed, whether the transmitting station used FSK or AFSK.

When listening to a teletype signal off air, you will soon get to recognize the familiar warble of Mark and Space tones. In the amateur shack the TTY machine is usually connected to an HF receiver or transceiver which the operator tunes so that the received audio is just the right pitch or audio frequency to trigger the demodulator's Mark and Space resonators.

If the receiver is slightly off the correct frequency the tones vary and the text becomes garbled or even lost altogether. To help the other station tune the receiver correctly, a RTTY operator can send a string of alternate R and Y characters RYRYRYRYRY. This pattern is chosen as it produces the most frequent and almost symmetrical alternation of Mark and Space tones, giving the receiving operator the best chance to tune the receiver before the "real" message starts. However, even if the signal is accurately tuned, the information can become garbled or completely lost due to interference, fading, or noise. Often, it is possible to make sense of the message even with parts missing, but RTTY is by NO means an error free mode!

I should point out that similar problems exist for other modes including Packet. While information can still fail to get through on the more sophisticated modes the Error Detecting capability of some, especially Packet and PACTOR, ensure that the operator will receive either accurate information or nothing at all. Usually, where "nothing at all" is received, the information will automatically be retransmitted when the radio is retuned, or the interference stops, (etc) and nothing is lost.

The Baudot code is a 5 bit code and those of you who are familiar with Binary Notation will know that the maximum number of values we can have with 5 bits is 32. That means that each unit of transmission, one keystroke if you like, can contain any one of 32 possible values. If you look up a table of Baudot codes you will see there are 32 values listed, one code for each letter of the alphabet plus a few other codes for other things such as a space and a Carriage Return. But, what if we want to send a number such as "9" or a question mark? These are not mentioned in that table because all 32 codes are already used.

The solution is rather similar to the Typewriter or Computer Keyboard where we have the Shift key to get various additional codes from the keyboard. Most keys will produce a different result if we hold down the Shift key as we type. Well, one of those original 32 codes is a special code known as FIGS (for Figures Shift). The convention is that when we want to send a number or some other special character such as a punctuation mark, we can do that by first transmitting a FIGS code.

Then instead of using that original table of 32 codes, we have a second table of codes to use, and that second table includes all ten numeric digits and various punctuation marks. Provided both sides of the conversation observe the convention, the sender can send a FIGS and start using the second table; the receiver will see the FIGS code and it too will interpret all data that follows from the second table.

With just 5 bits of data we then have almost 64 different codes we can send and receive. (I say almost because there is some duplication in the two tables, including a space and a Carriage Return but that is not important here). Even that many codes is not enough to handle all 26 letters of the alphabet in both UPPER and lower case, so RTTY systems always operate in upper case only.

If we wanted to type a big number (say "13579") we don't have to send FIGS before every digit. We send

that code only once and the receiver then will take EVERYTHING we type from now as if it belongs in the second table. When we want to revert to the normal alphabetic table of codes we can send another special code, this one called LTRS (for Letters Shift). Then everything goes back to normal, using the original alphabetic table of codes.

Normally we don't have to concern ourselves with these FIGS and LTRS codes. Our computing equipment will take care of those things for us. We just type away and rely on the system to generate and send those codes when necessary.

As I mentioned earlier, it is quite possible to lose bits here and there when receiving a RTTY signal, whether it be because of fading, interference, frequency drift, or whatever. One of the big problems with lost data is the possible loss of a FIGS or LTRS code! Say we had sent "13579" and then typed "HAPPY BIRTHDAY". Our equipment would have sent a LTRS code before the first "H" but what if the receiver did not copy the LTRS code we sent? Can you imagine what happens? As far as the receiver is concerned we are still sending numbers or other codes from the numeric table! So our "HAPPY BIRTHDAY" is going to come out looking something like "#-006 ?845#\$-6". And EVERYTHING we type from then on is going to look just as strange until we happen to send another LTRS code later. It is for this reason that many systems include an option to "Un-shift on space". If you have a multi mode TNC capable of handling RTTY, you will probably have this option in your TNC. If that option is ON then your receiving system will imply a LTRS code every time it receives a space. So if you seem to be copying lots of funny numbers from a strong, well tuned signal, try setting that option ON.

We can overcome some of these problems by using ASCII instead of using the Baudot code. With ASCII we can have 128 different codes so we do not need the FIGS/LTRS codes. All Personal Computers use ASCII as their native "language" so it would be a reasonable thing to use. Although not part of the defined ASCII standard, it has become an almost de-facto standard in the computer world that an additional 128 characters are available, often called Extended ASCII. But, despite these benefits, Baudot continues to rule the airwaves for Amateur and Commercial Teletype transmissions.

Today, RTTY is still a popular mode especially on the HF bands, and the advent of the "Glass Terminal", first the Dumb Terminal and now the Personal Computer, has brought this mode to even more operators the world over. Many specialized RTTY systems were developed for the Amateur enthusiasts but have been superseded now by the Personal Computer with one of the Multi Mode TNCs, which handle RTTY, and many other modes besides.

The latest Computerized RTTY equipment generally allows us to use the mode better, quieter, more efficiently, using less power and occupying less space than the old TTY machines, but the limitations of the mode remain.

## RTTY Operation

---

### Transceiver Settings

**Fine Tuning:** If your transceiver is equipped with a "FINE" tuning feature, always use that for RTTY tuning once you have found RTTY activity. Most of your adjustments can be made in software, and not with the transceiver's VFO if you prefer. In the PSK31 modes almost all tuning is done in software. For RTTY, I prefer to tune with the VFO. Some older rigs are really not stable enough for PSK31 operation and will drift considerably off frequency, but because of the wider bandwidth, they are fine for RTTY.

**USB:** Historically ham radio RTTY operators use LSB transmissions and a 170Hz shift between the MARK and SPACE signals, with the MARK signal being the higher in frequency. With MixW the convention is to use USB for all modes, since the program will adjust the inversion automatically.

**Note:** MixW automatically adjusts the Mark and Space tones depending on which sideband you are

operating on. If you are not using CAT, MixW needs to know which sideband your operating on to set the Mark and Space correctly. (See [inversion](#) in the Configuration topic).

**Filtering:** Optimum filtering depends on your transceiver's SSB filtering options and IF rejection characteristics. Wide filtering will enable you to work the largest spectrum without retuning your transceiver, but can also cause problems when there are strong adjacent signals. A narrow (RTTY or FSK) filter may help significantly with some radios and situations. Many transceivers, however, do not have narrow filtering options while operating in SSB modes. Consult your manual and experiment for the optimum configuration for your setup and conditions. The following waterfall display shows MixW's panoramic display when using a wide filter setting on the transceiver:

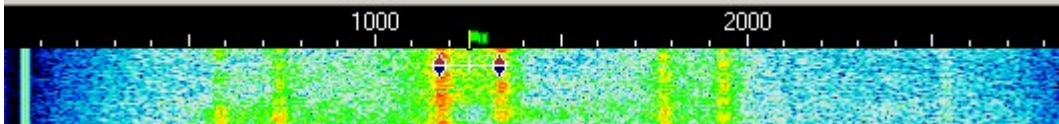

Here there are 3 different RTTY QSOs we could copy with the simple click of the mouse in roughly 3 KHz of spectrum. The strong one in the middle is currently selected and will provide the best print. The others may be too weak to copy 100 percent.

**Power:** RTTY uses a wide bandwidth and so it will require relatively high power compared to modes such as CW and PSK31. Never use more power than you need for any given situation, however.

## MixW Settings

**Mode:** Click on the mode box in the status bar and select RTTY. Next bring up the "Mode Settings" by clicking on the mode box in the status bar and selecting "Mode Settings". This brings up the following dialog box:

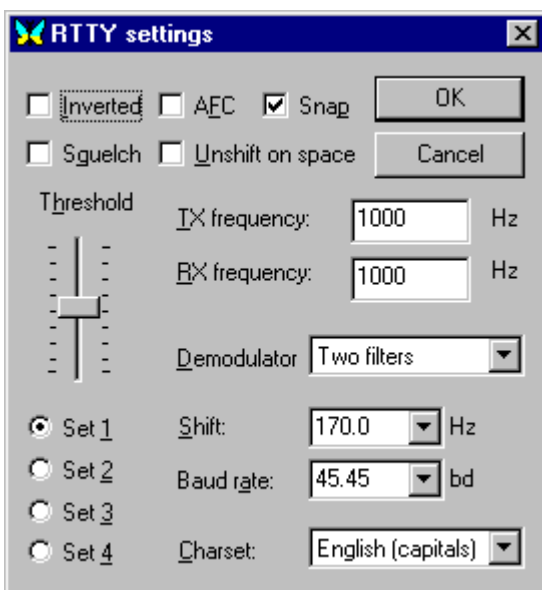

The TX and RX frequencies are set to the location of your cursor in the spectrum window. Keeping this around 1000 - 1500 Hz, will keep your transceiver operating close to the center of its pass band.

Shift is selectable (if you don't see what you want in the drop down box, any number can be typed in). Most RTTY uses a shift of 170 Hz, however setting this to 182 Hz often improves the copy for some signals.

Baud rate is also configurable. Most of the time this will be 45.45 Baud, but the other options are nice to have as well. You will sometimes find stations operating different shifts and baud rates.

The Character set can also be configured for the language you will be using.

The Mark and Space tones can be inverted by checking the "Inverted" box.

Up to four different sets of parameters can be configured for RTTY operation by selecting the different "Set" radio buttons (set 1 - 4). It is then possible to designate different operating parameters for each set, such as shift, baud rate, character set etc., which will then be remember for that set. These can then be easily recalled by selecting the different radio buttons.

**AFC** can be **on** to assist in tuning and tracking the RTTY signals. RTTY tuning is not as critical as the narrower modes, so AFC is more of an option than a necessity.

**Lock** should be **off** so you will be transmitting on the same frequency you're receiving. The exception here would be if you're working a station that is drifting and want that station to find your more stable frequency each time. Lock can also be used for working split.

**Inverted** when clicked will invert the positions of the MARK and SPACE frequencies. If you appear to be tuned into a strong signal and are only copying garbage, try clicking Mode | Inverted, or clicking the box in the RTTY settings. You will often find the station start to print 100 percent as a result.

**Note:** This feature works differently in MixW than most other SoundCard digital programs, so please read and understand the information about [inversion](#) in the Configuration Section.

**Squelch and Threshold** can be used and adjusted to suite your operating preferences.

### **Receiving RTTY**

RTTY signals display as two parallel lines usually 170HZ apart. Tune in a RTTY signal by pointing right in the center of the two tracks with the mouse and clicking the left mouse button. The text being sent by the station will then appear in the Receive Window. The RTTY tuning indicator is two diamonds, linked together with a bar and separated by the shift width you have selected in options dialog. The diamonds will move together to track and tune RTTY QSOs.

When working RTTY, especially during contest operation, I prefer to leave the tuning indicators in a position at roughly 1500 Hz (or centered in my Spectrum window) and then use the transceiver VFO set on "Fine" to tune in the RTTY signals. I find that I can tune more quickly this way, and also keep the QSO centered more effectively in my transceiver's pass band. RTTY is much easier to tune than most of the other digital modes.

### **Transmitting RTTY**

To transmit to a station, first tune it in as indicated above. Type your outgoing text in the Transmit Window. Press the TX/RX button and the text will be transmitted. You can continue to type, and that text will also be transmitted. As it is being transmitted, text in the transmit Window will also appear in the Receive Window. To stop transmitting, press the TX/RX button again. Pressing ESC will abort transmission and return MixW to receive mode, but the last several characters typed will not be transmitted.

**Note:** RTTY utilizes a limited character set, using UPPER CASE LETTERS ONLY. MixW will automatically convert lower case letters to upper case. You will also notice that not all punctuation marks are supported, although most of them are. The following characters are supported: - ( ) \$ ! " / : ? .

When transmitting, the waterfall will freeze and remain frozen until returning to Receive.

**Amtor**

---

# Amtor Introduction and Theory

## Amtor Operation

### AMTOR Theory

---

**With thanks to Tony Lonsdale, VK2DHU  
and Norm Sternberg, W2JUP**

AMTOR is a specialized form of RTTY. The term is an acronym for AMateur Teleprinting Over Radio and is derived from the commercial SITOR system (Simplex Telex Over radio) developed primarily for Maritime use in the 1970s.

In the late 1970's, Peter Martinez, G3PLX, made several changes to the SITOR protocol, which rendered it suitable for amateur radio use, and called it AMTOR.

AMTOR improves on RTTY by incorporating a simple Error Detection technique. The system remains relatively uncomplicated but AMTOR performs well even in poor HF conditions. While there can still be some errors in AMTOR data, the Error Detection gives excellent results for normal text mode conversations because of the high redundancy in plain language text.

There are two modes used in Amtor: ARQ and FEC. **MixW supports the FEC mode only.**

**ARQ:** The ARQ mode is a Synchronous protocol, which means both stations are synchronized to each other's signals.

In ARQ mode (Automatic Repeat Query), sometimes called Mode A, data is sent in groups of 3 characters. Although each character is only 5 bits (same as for RTTY), two additional control bits are added, so each character has a total of 7 bits. There are always 4 marks and three spaces in every transmitted character. If the receiving station gets some other combination it knows an error has occurred. The 40 percent overhead is considered worthwhile for error detection. This technique can identify most errors. The standard calls for no more than three errors in 100,000 characters.

The receiver responds to each 3-character group by sending either an ACK (ACKnowledge) code (if OK) or a NAK (Negative AcKnowledge). Each time the transmitting station gets a NAK, that 3-character group is sent again. If you listen around on the HF bands in the recognized Data Segments of the bands, you might hear a chirp-chirp sound that identifies an ARQ transmission. Even when there is no data actually being transmitted, the transmitting station continues to send idle "chirps" to maintain the link.

AMTOR supports a Listen Mode also and that allows you to monitor another ARQ session even though you are not participating in the session with the usual acknowledgements. Of course you are not able to participate in the error correction or synchronization.

One notable advantage of AMTOR is that when a link is failing AMTOR will try to reestablish synchronization between the sending and receiving stations rather than simply terminate the link.

**FEC:** In FEC mode (Forward Error Correcting), sometimes called Mode B, the sending station sends each character twice so this mode provides a means of transmitting to several stations at once. The receiving station does not acknowledge the data received. If a receiving station matches both instances of a character, that character will be printed, otherwise some error symbol is printed. This mode does not provide for the receiving station to ask for the missing data to be retransmitted. An FEC transmission sounds more like a Baudot RTTY signal.

The two stations need to keep in phase with each other so each FEC transmission is started with several sets of "phasing pairs" and these are sent at regular intervals even while there is no data being transmitted.

FEC Mode is still better than ordinary RTTY but its error detection is not as reliable as that in the ARQ Mode.

## AMTOR Operation

---

**MixW supports FEC mode only for AMTOR**, therefore AMTOR settings and operation are much like those for RTTY.

### Transceiver Settings

**Fine Tuning:** If your transceiver is equipped with a "FINE" tuning feature, always use that for AMTOR tuning once you have found AMTOR activity. Most of your adjustments can be made in software, rather than the transceiver's VFO if you prefer. Some older rigs are not stable enough for the narrow modes, but because of the wider bandwidth, they can be used for AMTOR.

**USB:** In the past AMTOR operators used LSB transmissions and a 170Hz shift between the MARK and SPACE signals, with the MARK signal being the higher in frequency. With MixW the convention is to use USB for all modes, since MixW will automatically invert your signal if you have told it you are in USB. See [inversion](#) in the Configuration Section for more information.

**Filtering:** Optimum filtering depends on your transceiver's SSB filtering options and it's IF rejection characteristics. Wide filtering will enable you to work the largest spectrum without retuning your transceiver, but can also cause problems when there are strong adjacent signals. A narrow (RTTY or FSK) filter may help significantly with some radios and situations. Many transceivers, however, do not have narrow filtering options while operating in SSB modes. Consult your manual and experiment for the optimum configuration for your setup and conditions.

**MixW Settings Mode:** Click on the mode box in the status bar and select AMTOR. Then click on the mode box in the status bar again and select "Mode Settings". This brings up the following dialog box:

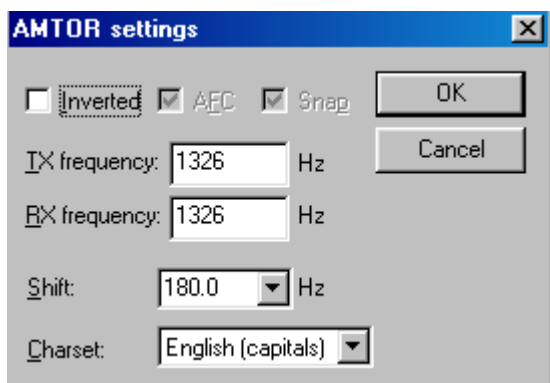

The TX and RX frequencies show the position of your cursor is in the spectrum window. Keeping this around 1500 Hz, will keep your transceiver operating close to the center of its pass band. Shift is selectable (if you don't see what you want in the drop down box, any number can be typed in). Most AMTOR uses a shift of 170 Hz. You can invert the Mark and Space signals by checking the "Inverted" box.

**AFC** should be on to assist in tracking the AMTOR signals but since AMTOR tuning is not as critical as some other modes, AFC is more an option than a necessity.

**Lock** should be **off** so you will be transmitting on the same frequency you're receiving. The exception here would be if you're working a station that is drifting and want that station to find your more stable frequency each time, or if you are working a net.

**Inverted** when clicked will invert the positions of the MARK and SPACE frequencies. If you appear to be tuned into a strong signal and are only copying garbage, try clicking Mode | Inverted, or clicking the box in the AMTOR settings. You will often see the station start to print 100 percent as a result.

**Note:** This feature works differently in MixW than most other SoundCard digital programs, so please read and understand the information about [inversion](#) in the Configuration Section.

### Receiving AMTOR

AMTOR signals display as two parallel lines usually 170HZ apart . Tune in a AMTOR signal by pointing right in the center of the two tracks with the mouse and clicking the left mouse button. The text being sent by the station will then appear in the Receive Window. The AMTOR tuning indicator is two diamonds, which are linked together with a bar and separated by the shift width you have selected in options dialog. The diamonds will move together to track and tune AMTOR QSOs. The following screen shot shows an AMTOR QSO in progress:

```
<4SET DE W4ET W4ET .... WELL, I GUESS THINGS ARE WORKING OKAY WITH THIS
MODE. I DID USE IT TO MONITOR SOME AMTOR BUT DIDN'T TRY TO TRANSMIT. I
GUESS THIS IS JUST THE FEC MODE ... KJK4SET DE W4ET K
```

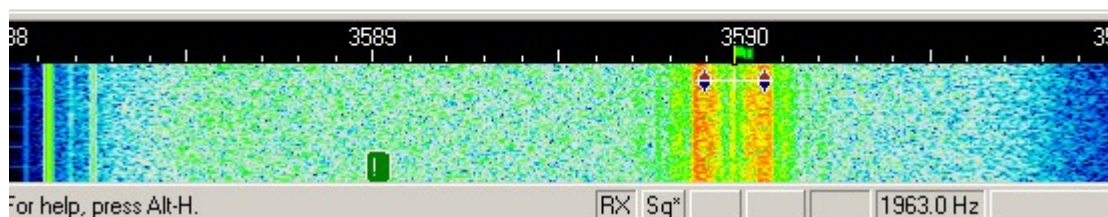

### Transmitting AMTOR

To transmit to a station, first tune it in as indicated above. Type outgoing text in the Transmit Window. Press the T/R button and the text in the Transmit Window will be transmitted. You can continue to type, and that text will also be transmitted. As it is being transmitted, text in the transmit Window will also appear in the Receive Window. To stop transmitting, press the T/R button (or one of the other toggles) again. Pressing ESC will abort transmission and return MixW to receive mode, but the last several characters typed will not be transmitted.

**Note:** AMTOR, like RTTY, utilizes a limited character set, using UPPER CASE LETTERS ONLY. MixW will automatically convert lower case letters to upper case. You will also notice that not all punctuation marks are supported, although most of them are. The following characters are supported in AMTOR: - ( ) \$ ! " ' / : ? .

## Packet

### [Packet Introduction and Theory](#)

### [VHF Packet Operation](#)



# HF Packet Operation

## TCP/IP Over AX.25

### PBBS Commands

## Packet Intro & Theory

---

Adapted from TAPR Publication #95-1, 1995

### History of VHF/UHF Packet

Packet radio has been around since the mid-1960's, but was first seen on the amateur VHF bands in 1978 through research done in Montreal, Canada in 1978, the first transmission occurring on May 31st. This was followed by the Vancouver Amateur Digital Communication Group (VADCG) development of a Terminal Node Controller (TNC), also known as the VADCG board, in 1980. This was then followed by [TAPR, Tucson Amateur Packet Radio](#), with the creation of the TNC-1 in 1982 and then the TNC-2 in '84-'85. The packet radio revolution ignited when TAPR sold over a thousand TNC-2 kits. The TNC-2 was what was needed to make this mode take off. There could be another packet radio revolution fueled by MixW and the other new software that utilizes the soundcard based TNC approach.

### What can I do?

Like any mode in the amateur service, packet provides a group of amateurs with a way of having fun and meeting one of our primary aims, "improving the radio art". But what can you do?

**PBBS systems:** Most cities have one or more packet Bulletin Board System, or PBBS for short. Many of these are operating on 145.01 MHz in the US. PBBSs do two main things: send and receive personal messages for their local users (like yourself) and send and receive messages or bulletins intended for people locally or around the world. Since the PBBS is part of a national system of other PBBSs, it has the ability to pass information or messages to any other PBBS in the US or the world. The second thing that BBSs do is pass local and national bulletins, which are messages intended to be read by everyone. In this way, amateurs can read the latest messages about the ARRL, AMSAT, TAPR, propagation, DX, and other bulletins on varied topics. Message passing is the primary purpose of a PBBS system, but PBBSs can also support callbook programs, help references, Internet access, and more. For a list of typical PBBS commands see the PBBS Commands topic.

**Keyboard-to-Keyboard:** Like the other amateur modes in MixW, packet radio can be used to talk to other amateurs directly. With the use of networks, amateurs can talk at a distance beyond the reach of their own stations by using the network. Keyboard-to-keyboard communication is one of the least frequent uses of packet communications, because amateurs are rarely on packet at the same time. Many packet operators send electronic mail using either personal mailboxes or a local PBBS. In this way, messages are read when the amateur is on the air.

**DX Packet Cluster:** Many cities have DX spotting nodes or networks. HF operators connect to their local DX Packet Cluster in order to receive reports on the latest DX. This type of packet came about from those interested in 'chasing' DX. Many amateurs like to frequent the HF bands looking for rare international operators to contact. A DX Cluster allows many HF operators to be connected over packet radio at the same time while operating HF and hunting for DX. When someone finds a DX station, they send a packet message to the DX Cluster, which then sends the information to all other packet operators using the DX Cluster. In this way, you have several stations monitoring the band, looking for DX. Often an amateur will 'spot' (hear) a DX station and then distribute the DX report almost instantly. DX Clusters allow everyone to operate more hard to find DX stations in one evening than was possible operating alone.

**RACES/ARES/NTS and Emergency Communications:** Packet radio is being used in many emergency services. Whether packet is used to pass messages accurately and in large quantities or to handle messages passed by the National Traffic System, it can provide an important function. A new application called APRS combines GPS (Global Positioning Satellites) with packet radio to allow a master station to plot on their computer the location of all other stations in the field. The purpose is to coordinate the exact position of weather spotters or searchers, without having to waste radio time informing the control station of their locations. It is also possible to distribute Doppler Radar images via the packet network. The small weather image file takes but a few minutes to retrieve and display.

**Networking:** The main packet networking scheme uses Digipeaters. Digipeaters work much like a voice repeater. Digipeaters look at the packet, and if its call is in the digipeater field, resends the packet. Digipeaters allow the extension of range of a transmitter by retransmitting any packets addressed to the digipeater.

An average packet station talks in a radius of about 10-30 miles. Packet Networks allow amateurs to widen the area of communications past their line of sight, by having a series of packet stations linked by radio, which can be used to get their packet messages to wherever the network goes. Much like the telephone system, networks provide long distance service outside the local area.

**Satellite Communications:** Many of the amateur radio satellites in orbit contain computer systems that provide packet capability. Most packet satellites provide BBS-like functions for messages to be passed to anywhere in the world within 24 hours. Several contain CCD cameras, which allow amateurs to download images of the earth and some allow users to retrieve data from the onboard experiments. Most satellites use AX.25 protocol with special software developed for satellite communications.

For additional information on SoundCard Packet, visit:

[TAPR, Tucson Amateur Packet Radio.](#)

## VHF Packet Operation

---

MixW has many options for Packet operation including both HF and VHF configurations. For HF packet information see HF Packet Operation.

TCP/IP over AX.25 packet radio protocol is also supported. See TCP/IP over AX.25.

MixW offers many user settable timing parameters, as well as the ability to send beacons, and act as a digipeater.

Switch to the Packet mode by selecting Mode | Packet. Next, open the settings dialog box by selecting Mode | Mode settings. This will bring up the following dialog box:

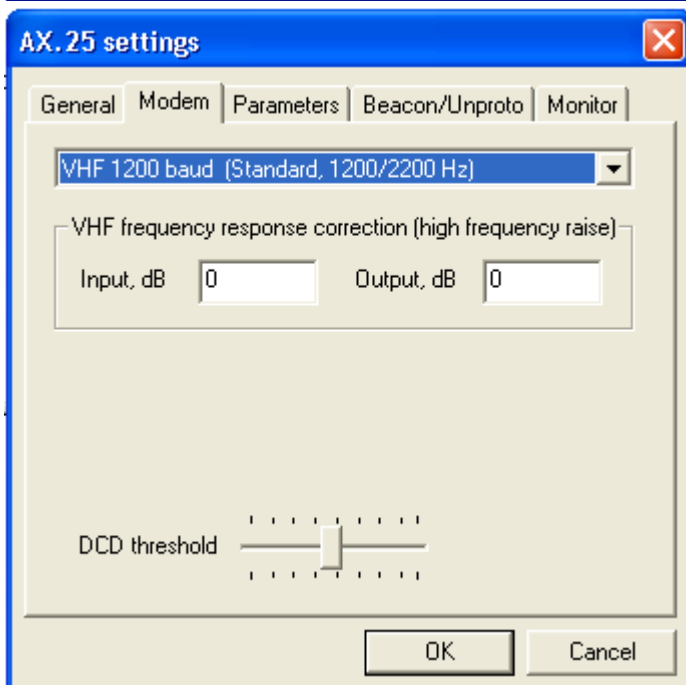
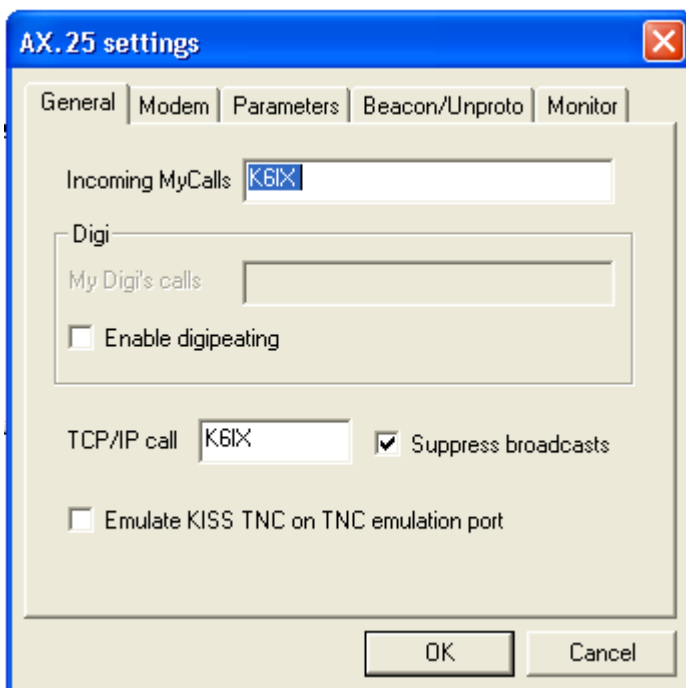

Enter your callsign in the general tab, and select the VHF 1200 baud Standard (or the settings you wish to operate) in the Modem tab. If you want MixW to also act as a digipeater, enter your digipeater call sign, and check the box to enable digipeating. The "use PSK" and the "OEM" checkboxes should be left unchecked for most operations. The Parameters, Beacon/Unproto, and Monitor tabs can be ignored for the present. You can customize your packet timing parameters in order to facilitate connecting to certain BBSs or other unique situations by clicking on the Parameters Tab. The default settings here should get you started. The Beacon/Unproto tab can be used to set your beacon text and parameters, and the Modem window can be used if you have a hardware TNC and want to use it instead of your soundcard for packet operation.

Next you need to find a packet station or PBBS to connect too. Unlike HF packet, VHF tuning is almost automatic, so long as you're using a standard VHF/UHF FM radio. Simply tune your radio to the packet frequency you are interested in. You will notice that you cannot tune MixW by clicking in the Spectrum or Waterfall displays as you do for the other modes. This is because MixW assumes you are tuned right on frequency (due to the nature of VHF/UHF FM operations) and will be using the standard audio tones for the packet mode you have selected.

After first monitoring the frequency to determine that the station or PBBS you want to connect to is on

the frequency, you then initiate the connect command. To do this, open the connect dialog box by selecting Mode | Connect, which will bring up the following dialog box: (You can also bring up the connect dialog by simultaneously depressing the Ctrl-Alt-c key combination.)

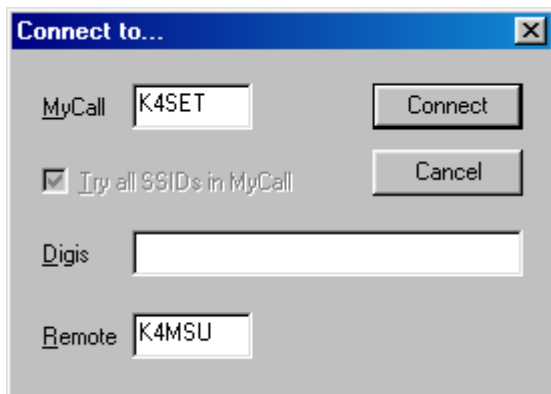

Enter your callsign in the MyCall box and the callsign of the station or PBBS you wish to connect to in the Remote box. If you are planning to connect through a Digipeater path, enter that in the Digis box. Next, click on the connect button and MixW will initiate a connection with the remote station.

As you can see in the following screenshot, I have connected directly to the K4MSU PBBS (our radio club operates this PBBS on 145.01MHz in Murray, KY) and I have written a message to my friend Ron, W4ET, who is also a user of this PBBS. What you are seeing here is the message I sent previously sent back to us by my use of the R <message #> command to read back the message.

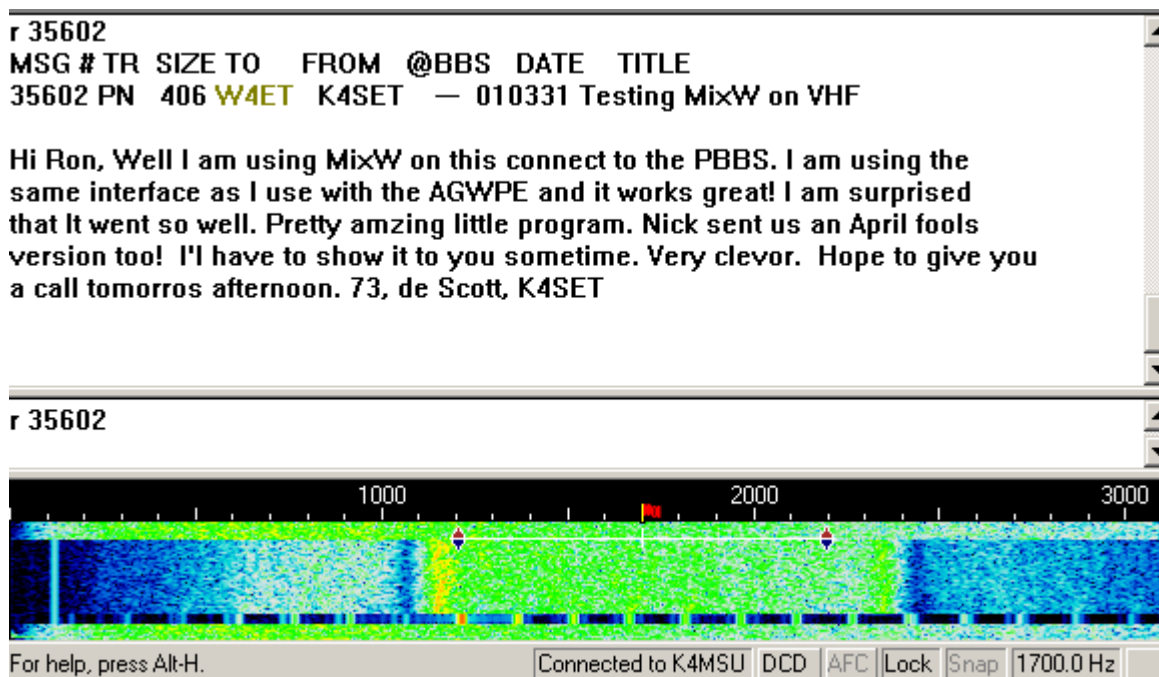

When operating packet you will notice that each station must acknowledge accurately receiving the other station's packets (this happens automatically through the software), which results in short bursts of activity while each station responds. During poor band or path conditions it may take several attempts before each station accurately receives the other's packets.

When you are finished with the QSO, or PBBS session, you must disconnect from the remote station by selecting Mode | Disconnect, which will send the disconnect string to the remote station and end your connection and QSO. **Note:** If you are connected to a PBBS, you should first log off the BBS with the Bye command, then if you remain connected you can initiate the disconnect command, but the BBS will most likely initiate the disconnect process.

For a list of typical PBBS commands see PBBS Commands

# HF Packet Operation

MixW has many options for Packet operation including both HF and VHF configurations. For VHF packet information see [VHF Packet Operation](#). MixW offers many user settable timing parameters, as well as the ability to send beacons, and act as a digipeater.

Switch to the Packet mode by selecting Mode | Packet, or by clicking on the Mode box in the Status bar and selecting Packet. Next, open the settings dialog box by selecting Mode | Mode settings. This will bring up the following dialog box:

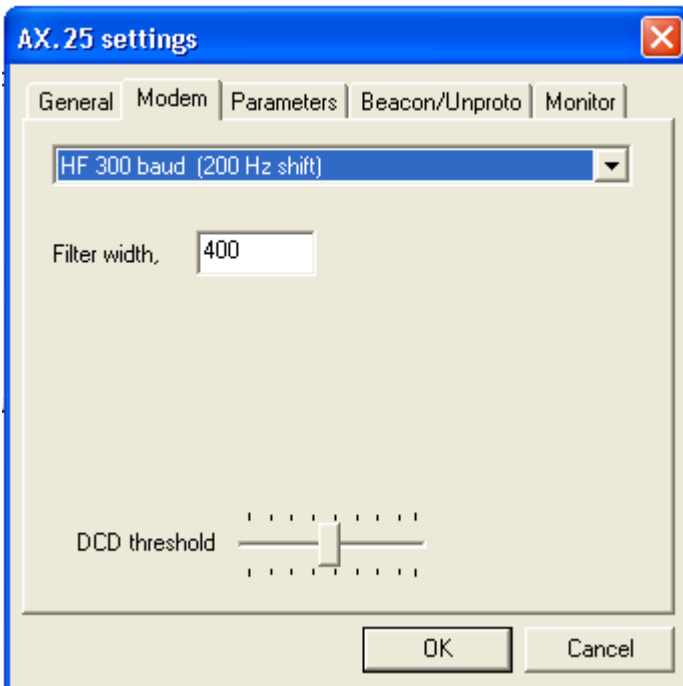
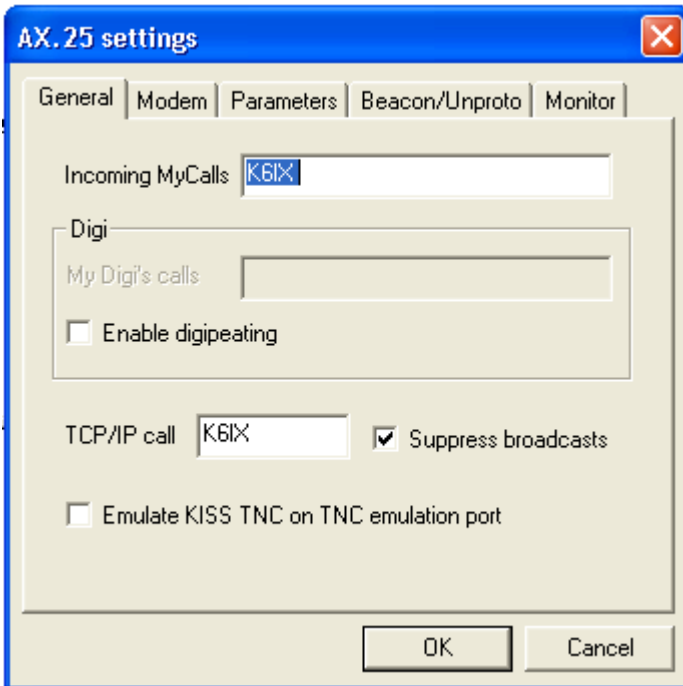

Enter your callsign, in the General tab, and select "HF", in the Modem tab, for the mode you wish to operate. All HF packet operations are using 300 Baud at the present time, as conditions on HF do not support the higher baud rates. If you wish to act as a digipeater, enter your digipeater call sign here and check the box to enable digipeating (this is more common for VHF packet). The Parameters, Beacon/Unproto, and Monitor tabs can be ignored for the present. You can customize your packet timing

parameters in order to facilitate connecting to certain BBSs or other unique situations by clicking on the Parameters tab.

Next you need to find a packet station or PBBS to connect too. The following screen shot shows a packet QSO as tuned in and monitored in the waterfall display:

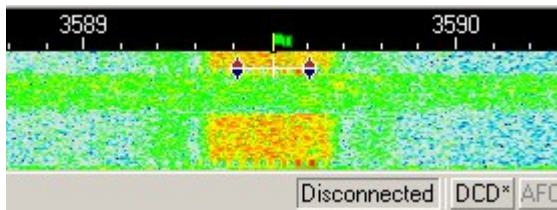

Tune a Packet signal by pointing right in the center of the signal with the mouse and clicking the left mouse button. You may need to fine tune by using the CTRL-arrow keys. The text being sent by the station will then appear in the Receive Window. The Packet tuning indicator is two diamonds which are linked together with a bar. The diamonds will move together to track and tune Packet connections.

Once you have tuned in and monitored packet activity you must connect to the station or PBBS you have received in order to have a QSO or PBBS session. To do this, open the connect dialog box by selecting Mode | Connect, which will bring up the following dialog box:

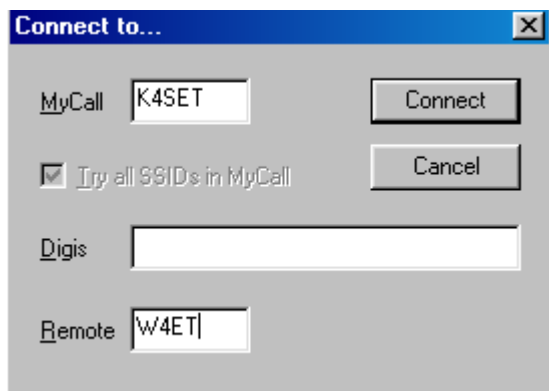

Enter your callsign in the MyCall box and the callsign of the station or PBBS you wish to connect to in the Remote box. If you are planning to connect through a Digipeater path, enter that in the Digis box.

**Note:** Digis are more common on VHF packet than HF.

Next, click on the connect button and MixW will initiate a connection with the remote station.

As you can see in the following screenshot, we have now connected directly to Ron, W4ET. (Actually, in this case Ron imitated the connection, and my station automatically connected to him without me having to do anything:

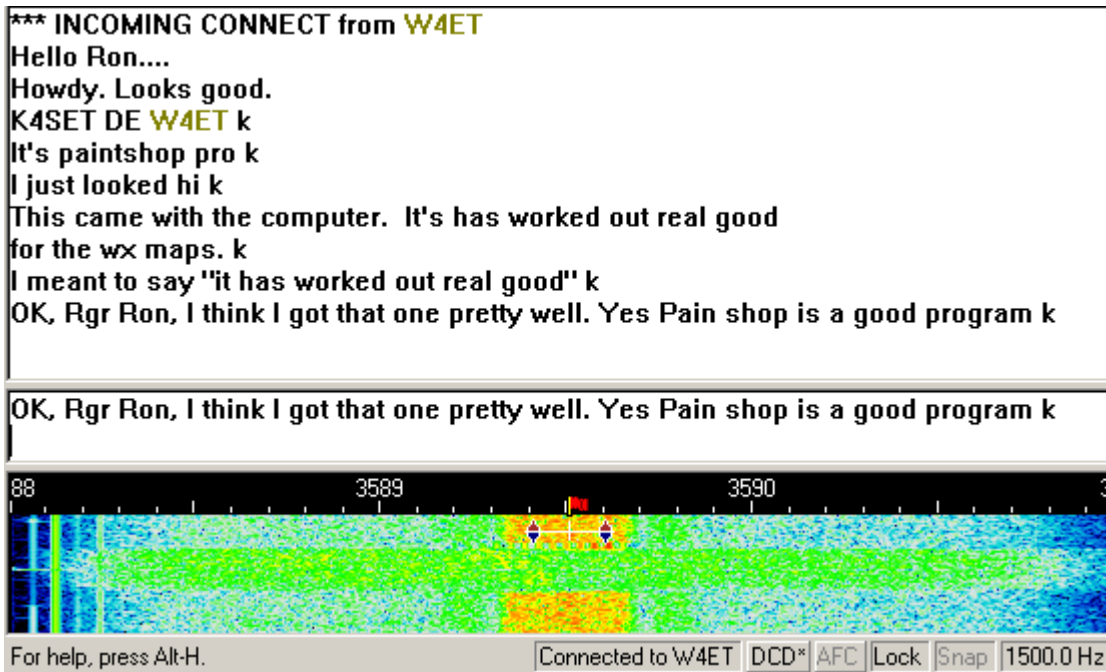

We can type back in forth this way. When doing so you will notice that each station must acknowledge accurately receiving the other station's packets (this happens automatically through the software) so you will see short bursts of activity while each station responds. During poor band or path conditions it may take several attempts before each station accurately receives the other's packets.

When you are finished with the QSO, or PBBS session, you must disconnect from the remote station by selecting Mode | Disconnect, which will send the disconnect string to the remote station and end your connection and QSO. **Note:** If you are connected to a PBBS, you should first log off the BBS with the Bye command, then if you remain connected you can initiate the disconnect command, but the BBS will most likely initiate the disconnect process.

For a typical list of PBBS commands see [PBBS Commands](#)

## TCP/IP over AX.25

MixW 2 supports TCP/IP over AX.25 (datagram mode). This means that you can use standard Windows' software to communicate with other TCP/IP systems (UNIX/Linux, AGW Packet Engine, Flexnet, MixW 2) over a VHF radio channel.

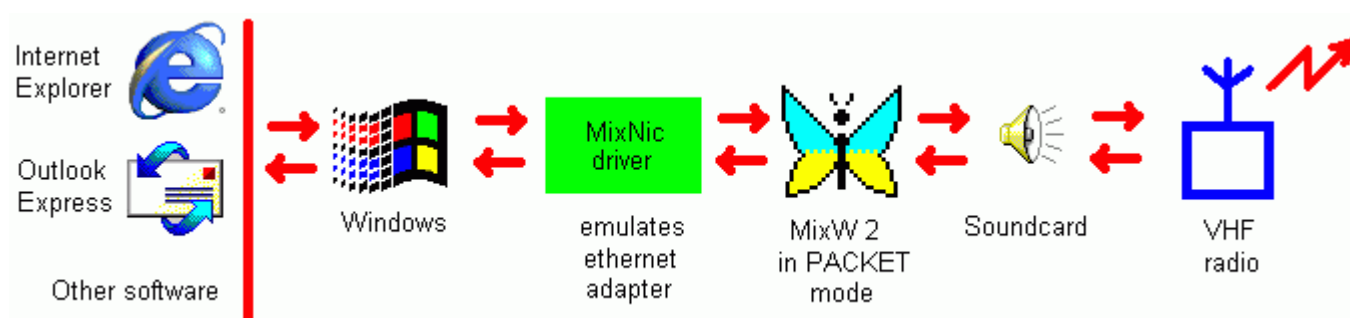

Download the virtual network adapter driver for Windows 98/ME/2000/XP from Nicks website by clicking here:

<http://mixw.net/files/MixNic6.zip>

Or, for early Windows 98 versions:

<http://mixw.net/files/MixNic6Old.zip>

Unzip the files to a separate folder and see the ReadMe.txt file for installation instructions.

These drivers have been tested with Windows 98 SE 4.10.2183A, Windows 2000 5.00.2195 SP2, Windows XP 5.1.2600.

## **PBBS Commands**

---

### **MSYS PACKET BBS COMMAND SUMMARY**

Version 1.18 (The first letter alone will invoke most major commands: example, B = Bye)

**Note:** The MSYS commands are used on many other PBBSs as well.

#### **A Commands**

Abort.....Stop current action

#### **B Commands**

Bye.....Disconnect

#### **C Commands**

Conference.....Multi-user/DX Node

#### **D Commands**

Download.....Download from FILES

#### **G Commands**

Grep.....String search file

#### **H Commands**

Help.....Help

#### **I Commands**

Information.....PBBS hardware

Info.....Basic Information

ID.....Port definitions

#### **J Commands**

Just Heard.....Log

JB.....BBS Stations

JD.....Digipeaters

JG.....Gateways

JK.....K and KA nodes

JM.....MSYS PBBSs

JN.....Net/Rom

JT.....TCP/IP protocol

#### **K Commands**

Kill.....Kill a message

KM.....Kill mine

KT.....Kill traffic

K-Nodes.....K-Node output



## **L Commands**

List.....Message headers  
L x.....List category x  
LC.....List categories  
LM.....List mine  
LN.....List not read  
LT.....List traffic  
LL.....List last message  
LL #.....List last #  
LO #.....List older #=yymmdd  
LU.....List unread to you  
LY.....List read to you  
LW.....List weather  
L?.....List ? forward  
L<< x.....List fm x=callsign  
L>> x.....List to x=callsign  
L@ PBBS.....Messages to PBBS  
L #.....List since #  
LL #.....List last #  
L # #.....List from # to #  
L"x".....List with x=string  
L'x'.....List with x=sTrInG  
L\$.....List bulletins

## **M Commands**

Message.....Message of the day

## **N Commands**

The N commands are used while to give the BBS your information, either the first time you log on, or if you need to edit your information:

Name.....First name  
NH.....Home board  
NQ.....QTH=City,  
NZ.....Zip code

## **P Commands**

Path.....Path to a user  
PF.....Path to a PBBS  
PC.....Request a callsign

## **R Commands**

Read.....Read a message  
R x.....Read all category x  
R@ xxxx.....Read all at xxxx BBS  
R> xxxx.....Read all to xxxx  
R< xxxx.....Read all from xxxx  
RM.....Read Mine  
RE.....Read for export  
RH.....Read with headers  
RN.....Read only text  
RP.....W/O mark as read  
REply #.....Reply auto title  
REP # .....Reply to given message number. If you put a period after the number, a title will automatically be generated. Same as SR command.

The following variations of the R command read messages:

R ## ..... Reads the given message numbers Ex: R 12734 11521 27185  
 RM ..... Reads your messages (Read Mine)  
 R .....category Reads the messages in a given category ("TO" field). Ex: R SALE  
 R> .....callsign Reads msgs with given "TO" field  
 R< .....callsign Reads msgs from given callsign  
 R@ .....callsign Reads msgs with given @BBS Ex: R@ ARRL  
 RH ## .....Like R but displays all the R: lines as well (Read Headers)  
 RP ## .....Like R but doesn't mark msgs as read (Read Preview)  
 RN ## .....Like R but gives msg text only (Read Noheaders)  
 RE ## .....Reads the given message numbers in export form (Read Export)  
 REM .....Reads all messages to you in export form (Read Export Mine)  
 #RS .....Reads all messages to SYSOP (Read Sysop)  
 #RES.....Reads all messages to SYSOP in export form (Read Export Sysop)  
 #R\* .....Reads held messages showing text  
 #R+ .....Reads held messages showing why held verbosely  
 #R- .....Like R+ but very concise

Typically, after a screefull of lines is displayed on your terminal, you will be asked:

More? [Y]es, No or Continuous

Press just return for next screenfull, N to quit reading this message or category), or C to display all the rest without pausing. The number of lines per screen is set by the X command.

### > REQDIR

To list files in subdirectory XXX, put /XXX in the title of a msg to REQDIR.  
 For information on how to request a file, send a msg to REQFIL and put  
 REQFIL.HLP in the title.

### > REQFIL

To request a file, send a private message to REQFIL at this BBS. Put in the  
 title the name of the file you want. If the file is in a subdirectory,  
 include the name(s) of the subdirectories. Examples:

SP REQFIL @ WA8BXN  
 REQFIL.HLP

## S Commands

The S command is used to send messages. It several formats:

SP call @ bbscall.haddr Send a private msg Ex: SP K8EIW @ WB8BII.OH.USA.NA

ST zipcode @ NTSst Send traffic msg Ex: ST 44070 @ NTSOH

SB category @ route Send a bulletin Ex: SB NEED @ ALLOH

SR msg# Send reply Ex: SR 12723 or SR 12723.

In SB if call is a user of this system you can omit the @ bbscall.haddr

In ST, NTSst means to replace st with the state its going to: OH for Ohio, etc.

In SR, if you put a period after the msg #, a title will automatically be made  
 by preceeding the original title with RE:

IMPORTANT: SR tries its best to determine where the reply should go, but  
 it is not always perfect! The same applies to the REP command.

Never uses SSID's in callsigns (ex: don't use WA8BXN-2, just use WA8BXN)

Hierarchical addresses are of the form state.country.continent. Other parts  
 may be used by a particular BBS, if you know them, use them.

When sending personal messages to a distant bbs, it is a good idea to put  
 the destination city and state in the title.

When you are done typing your message, end it with either ^Z (Control-Z) or  
 Putting \* at the beginning of a line makes it a comment.

It also suppresses the next command prompt (but the system will  
 be waiting for another command). \* is useful to answer the SYSOP if you  
 get a MESSAGE FROM SYSOP ...

Send.....Send a message

^A.....Abort message  
CC.....Carbon copy  
SP.....Send personal  
ST.....Send traffic

### **T Commands**

The T cmd is used to connect to the sysop's keyboard. This if the sysop is present you may enter into a direct conversation. If there is no response from the sysop in 60 seconds you will be returned to the BBS. TCP/IP Telnet users note: Server 87 connects directly to the keyboard without going through the bbs.

### **U commands**

The U cmd lists the current users of MSYS and what they are doing. The UP command may be used to upload ASCII files. You must be authorized by the SYSOP to upload files. After you use the UP command you will be asked the file name to upload. Follow the prompts given by the command.

### **V Commands**

The V command gives the version of this software.  
Version.....Version

### **W Commands**

The What command lists the available files for downloading. The format: W - Lists all files with sizes. A directory name may be specified to list files names in directories that appear in the list.

What.....Download list  
W x.....What in x=subdir

### **X Commands**

The X command can be used to set a variety of options. If no argument is given, X simply toggles and displays the new Expert status. If a number is given after X, this is the number of lines to display for a command before asking More? To continue displaying the current message when More? is sent press return. To abort the message, type N and then return. This facility has been added to prevent a long message from scrolling off your screen faster than you can read it. Experiment with different values until you find one that pleases you. To not use this facility, set the number of lines to zero. Examples:

X.....Toggle expert  
X 20 (pause after every 20 lines) X 0 (don't pause ever)  
XF Set "fast" mode: BBS will put more than one line per packet  
XS Set "slow" mode: BBS will put only one line per packet.  
Note: If you have very good path to bbs, use XF. If you have a poor path to bbs, use XS since short packets make it through easier.  
XC..... toggles the automatic display of msg catagories when you connect to the bbs and are using non-expert mode.  
XR toggles the automatic asking if you want to reply to a msg after you read it. Can be useful if you get a lot of personal mail.  
XU toggles the automatic display of Unread mail when you connect.  
X #.....Lines per page

### **Y Commands**

Yapp.....Down and uploads  
YW.....YAPP Directory  
YD.....Download a file  
YU.....Upload a file  
YW .....Lists available files for YAPP Download  
YD filename Downloads specified file using YAPP protocol  
YU filename Uploads specified filename using YAPP protocol

\*.....Comment to sysop

^ZH.....Conference help  
^ZQ or /ex.....Return to PBBS  
^ZU.....List users  
^ZA #.....Invite user on #

^Z gets you this file, as you may already know!

SP REQFIL @ WA8BXN  
XXX\NEWFILE.DAT

^Z

would get you file NEWFILE.DAT from directory XXX.

SP REQFIL @ WA8BXN  
STUFF.BAS @ K8EIW

^Z

would send the file STUFF.BAS back to you at BBS K8EIW, instead of the one from which you sent the message.

NOTE: YOU CAN REQUEST ONLY ONE FILE PER MESSAGE TO THE SERVER!

### **NETWORK NODE COMMANDS**

BBS.....Connect to the PBBS

Bye.....Disconnect

Connect CALL...Connect to call

C# CALL...C on port # to call

Help.....Help

Nodes.....Nodes heard

Justheard.....Limited output JH

Nodes CALL..Info on node

Ports.....Port information

Routes.....Direct connect nodes

Route CALL..Other node

State Talk.....Page Sysop

Users.....Users/nodes

## **Pactor**

---

### **Pactor Introduction and Theory**

### **Pactor Operation**

## **Pactor Intro & Theory**

---

**From the website of RICHARD B. GRIFFIN, NB6Z**

### **I. Introduction**

PACTOR, specially designed for operation in noisy and fluctuating channels, is an improved half-duplex synchronous ARQ system combining the reliability of Packet with the fixed AMTOR time frame.

Principal design considerations

PACTOR comprises all important Packet (2-way) characteristics:

- fixed timing structure and full synchronism to ensure maximum speed
- fast and reliable changeover / break-in
- required bandwidth less than 600 Hz
- 100% ASCII compatible (true binary data transmission)
- extremely low probability of undetected errors (16 bit CRC)
- independent of shift polarities
- no multi-user overhead in a narrow-band channel
- inexpensive hardware (Z80 single-board)
- high operational comfort (built-in message storage system, etc.)
- listen-mode (monitor)
- FEC-mode (CQ-transmissions etc.)

As a novelty in Amateur RTTY, some additional powerful features have been realized:

- optimal coherent mode, i. e. system clocks locked to frequency standards (e.g. DCF77, TV deflection signals and other high precision broadcasts)
- online data compression (Huffman coding)
- automatic speed change (100/200 baud) without loss of synchronization
- fully acknowledged link termination (no QRT-timeout required)
- memory ARQ (even noisy packets can be restored)

## II. System Details

### 1. Timing

The basic Pactor transmission frame is very similar to AMTOR; blocks (packets) containing data information are acknowledged by short control signals sent out by the receiving station.

Shift levels are toggled with every cycle in order to support memory ARQ. Since the shift polarity is clearly defined at synchronization time, any conventions concerning 'mark/space' become obsolete.

- cycle duration : 1.25 sec
- packets : 0.96 sec = 192 (96) bits at 200 (100) baud
- control signals: 0.12 sec = 12 bits, each 10 msec long
- Control Signal-receive gap : 0.29 sec

Change of transmission speed only alters the internal packet structure; all other timing parameters remain constant.

### 2. Packets

General packet structure:

/header/..20 (8) data bytes at 200 (100) baud../status/CRC/CRC/

header : This byte enables fast synchronization and delivers auxiliary information (memory ARQ, listen mode)

data : arbitrary binary information

status : system control byte (2 bit packet number, tx-mode, break-in request, QRT)

CRC : 16 bit cyclic redundancy check based on CCITT polynomial  $X^{16}+x^{12}+x^5+1$ , calculated over the entire packet (except header)

### 3. Control signals (CS)

Four CS are used. As a compromise between reliability and fast detection, a CS length of 12 bit was chosen.

CS1: 4D5 CS2: AB2 CS3: 34B CS4: D2C (all hex numbers, LSB right)

The mutual Hamming distance is 8 bit, thus minimizing the chance of receiving a false CS. CS1/2 and CS3/4 form symmetrical pairs (bitreverse patterns). CS1..3 have the same function as their AMTOR counterparts; CS4 serves as the speedchange control. In contrast to AMTOR, CS3 is transmitted as head portion of a special changeover packet.

The calling station ('master') sends special synchronization packets: /head (100 bd)/..address (8 bytes, 100 bd)..address (8 bytes, 200 bd) Normally, the receiver only uses the 100-baud-section to achieve a fast synchronization. The 200-baud-section supplies additional information about the channel quality: if it is received correctly, the first CS will be CS4, otherwise CS1 is sent. After in turn having synchronized a CS4 or CS1, the master will continue with sending normal data packets at 200 or 100 baud, respectively. The first transmitted characters contain the 'system level number' (PACTOR software-version), followed by the master address (callsign).

#### **4. Changing the transmission direction**

Similar to AMTOR, the receiving station (RX) can change the transmission direction whenever it has received a valid packet. For this purpose a special changeover-packet is transmitted, starting at the CS time frame. The transmitting station (TX) will switch to RX mode immediately after it has received the CS3 which forms the first section of the changeover- packet. It then reads in the rest of that packet and transmits a CS (CS1 and CS3 = acknowledge, CS2 = reject) timed at the last three bytes of the former packet frame. To force a break in, the TX sets the BK-status-bit (this corresponds to AMTOR '+ ?').

#### **5. Speedchange**

Speeddown only being useful in poor conditions or at low data input rates (e. g. manual typing), both directions are treated unsymmetrically.

##### **i) Speeddown**

The RX may request speeddown after any incorrectly received packet by sending CS4, which immediately forces the TX to build up 100-baud-packets (any unconfirmed 200 baud information is repeated at low speed).

##### **ii) Speedup**

Any valid packet may be confirmed with CS4, forcing a TX speedup. In case the following high-speed-packet is not acknowledged after a number of tries, the TX will automatically perform a speeddown.

#### **6. Termination of a PACTOR contact**

Cutting an ARQ link inevitably leads to the problem that information has to be transmitted without final acknowledgement (Second WAA theorem). Pactor applies special QRT packets, providing an expensive but rather effective solution. These packets contain an active QRT status bit and the RX address in byte-reverse order (low speed pattern). If this address is found during the standby synchronization procedure, the RX responds with a single transmission of the final CS (The timing relations before stby are stored). This method will always guarantee a well-defined QRT.

#### **7. Data Compression**

Character frequency analysis of typical English or German texts shows that the average amount of information per character does not exceed 4 bits. For that reason, ASCII text transmissions often carry a redundancy of 50%, which could be avoided by using a variable length code matched to the character distribution. The most popular example of such a code is the Morse code; PACTOR data compression mode applies Huffman coding with nearly optimum efficiency, yielding up to 100% speed gain. Every packet contains a compressed data string; character code lengths vary from 2 to 15 bits.

#### **8. Memory ARQ**

In conventional ARQ systems the TX has to repeat a packet until it has been received completely error-free. It is evident that the probability of receiving a complete packet dramatically decreases with lower S/N ratio. The only way to maintain the contact in that case is to shorten packet length and/or to apply error correcting codes which in turn will greatly reduce maximum traffic speed when conditions are good. The method chosen by WAA Research Group is to sum up corresponding bit samples of subsequent packets and to test if the mean value (reduced to a 0/1-decision) passes the CRC. To keep quantizing errors small, the samples are taken from the FSK-demodulator low-pass-filter output by means of an 8-bit AD-converter. Assuming white Gaussian noise, this accumulation method - also known as 'memory ARQ' - will obviously converge even at a WA4EGT, QRA WA2MFY/SYS1: low S/N ratio. Furthermore, since shift levels are toggled with every transmission, constant interfering signals within the receiver passband will not affect the resulting mean value. To prevent accumulation of old request packets, the header is

inverted with every new information packet, thus serving as a RQ indicator (similarity test).

### 9. Listen Mode (Monitor)

This mode resembles Packet Radio monitoring: the receiver scans for valid packets which are detected by CRC match. This 'brute force' method was chosen in order to ensure maximum flexibility, although it consumes a considerable amount of the available CPU capacity.

### 10. FEC Transmissions

CQ and bulletin transmissions are supported by means of a special non-protocol mode. Packets are transmitted with one or more repetitions; the CS receive gap is omitted. Since the listen mode does not require synchronization, the transmitting station possesses great freedom of selecting packet repetition rate and speed.

### 11. Practical Aspects

The first PACTOR programs were running on 'breadboarded' Z80 singleboard-computers. These early experiments led to the development of a stand-alone 'PACTOR-Controller' with built-in modem and tuning-display. The conventional operating modes BAUDOT and AMTOR were added in order to maintain compatibility and - what might be more interesting - to allow easy comparisons. Assuming typical conditions, PACTOR traffic can be expected to run 4 times faster than over an AMTOR link.

## Pactor Operation

---

MixW supports Pactor receive (listen mode) only via the soundcard interface. To transmit Pactor with MixW you must use a hardware TNC. See the TNC Configuration and Operation topic.

To receive Pactor without a TNC, set the mode for Pactor by selecting Mode | Pactor from the main menu, or by clicking on the Mode box in the Status Bar and selecting Pactor. Pactor sounds like chirping bursts of packet like transmissions. The following picture shows the waterfall-tuning window tuned to a Pactor QSO:

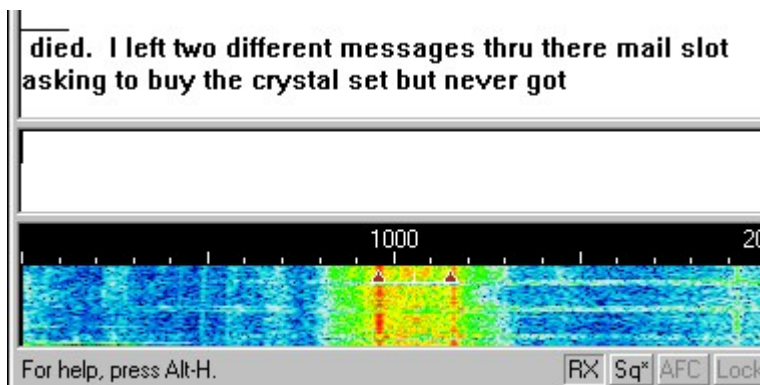

As you can see, the width is similar to RTTY and it also utilizes the same two-diamond-with-a-bar indicator used by RTTY, MFSK, and packet.

## PSK

---

### PSK Introduction and Theory

## PSK31 Operation

## PSK63/125 Operation

### PSK31 Intro & Theory

---

PSK31 is based on an idea by SP9VRC and developed by Peter Martinez, G3PLX, who also developed AMTOR. Based on RTTY, PSK is used for live keyboard-to-keyboard QSOs at 50 WPM (31 Baud) and uses "Phase Shift Keying" to signal mark and space values, instead of changing the frequency.

DSP is used to change the phase by 180 degrees when a switch from mark to space is needed. DSP analysis by the program instantly detects this "Phase Shift".

PSK works in a very narrow bandwidth, which sharply reduces noise and QRM. This narrow signal also makes it an excellent QRP (low power) mode, with between 5 and 10 watts producing excellent inter-continental paths in some cases.

The front-end DSP filter and pulse shaping keep the waveform compact, approximately 40 Hz at -3dB and 80 Hz at -40 dB. Pulse shaping uses a raised cosine to ramp amplitude during phase transitions and leaves the amplitude at full value during no phase reversals.

PSK31 uses much less bandwidth than traditional digital modes as shown here:

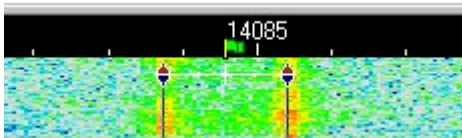

Picture of RTTY QSO in the MixW display.

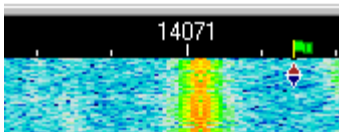

Picture of a PSK31 QSO in the same display.

#### **PSK31's two modes: BPSK and QPSK**

In the QPSK mode, instead of just keying by phase reversals, or 180-degree phase-shifts, an additional pair of 90 and 270-degree phase-shifts are possible.

If you think of BPSK as reversing the polarity of the signal, then QPSK can be thought of as two BPSK signals on the same frequency, but 90 degrees out of phase with each other, and with only half the power in each.

The extra speed in QPSK is used for error correction. This works well under most conditions. Certain noisy conditions, and weaker signals, can benefit from the full power (single signal) of the QPSK mode.

**Visit the PSK31 Official Home Page at:**

<http://aintel.bi.ehu.es/psk31.html>



**Note:** Because this is commercial software, Peter Martinez, G3PLX's Introduction and Theory of PSK31 cannot be included as part of these help files, but these really should be reviewed for a better understanding of PSK and its development. Peter Martinez's outline and theory of PSK31 can be viewed on the website of MixW beta tester and help file contributor, RICHARD B. GRIFFIN, NB6Z at the following link: <http://myplace.frontier.com/~nb6z/start.htm>

MixW has full BPSK31 and QPSK31 capabilities, but Nick did not use the G3PLX source code to implement it. By using his own source code, Nick is in keeping with Peter's guidelines for the use of PSK31 in commercial software.

The MixW team is very grateful to Peter for PSK31, a great gift to the radio art.

## PSK63/125 Operation

---

### PSK63 & PSK125 Basics

BPSK63, BPSK125, QPSK63 & QPSK125 are provided as a variation of BPSK31 & QPSK31 by changing the BAUDRATE using either a macro command or the Settings Dialog. Two macros are suggested, one for switching to PSK63/125 and one for changing back to PSK31.

PSK63 will operate exactly like PSK31, except that the signal will be twice as wide, and you can transmit twice as fast (if you can type that fast). By the same token, PSK125 will be 4 times as fast.

MixW will properly recognize the mode in the Log based on the baud rate. Internally however MixW registers the mode as only BPSK31 or QPSK31. Thus any mode specific macros for BPSK63/125 or QPSK63/125 will not be selected.

For earlier releases of MixW the mode xPSK31 then Baud was used but the latest releases just a macro of MODE:xPSKbb(b) is needed. This now causes mode macros for all 6 modes to be available.

### Macros to change modes

	Early Mixw versions Macro	Latest Mixw versions Macro
Macro for BPSK63	<MODE:BPSK31><BAUDRATE:62.5>	<MODE:BPSK63>
Macro for BPSK125	<MODE:BPSK31><BAUDRATE:125>	<MODE:BPSK125>
Macro for BPSK31	<MODE:BPSK31><BAUDRATE:31.25>	<MODE:BPSK31>

See [One key macro to switch PSK modes.](#)

You can also change the baud rate by selecting the BPSK31 Settings Dialog

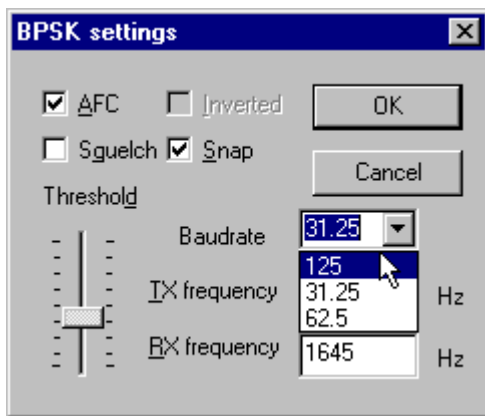

**NOTE:** PSK63 & 125 are normally found above the traditional PSK31 operating frequencies rather than intermixed with them since PSK63 & 125 require more bandwidth. If you change from PSK31 to PSK63/125 during a QSO you risk expanding into another user's signal, which will not improve your image as a courteous and considerate operator.

## MFSK

---

### MFSK Introduction and Theory

### MFSK Operation

### MFSK Image Mode

## MFSK Intro & Theory

---

By Murray Greenman, ZL1BPU

### **MFSK Overview for Beginners**

MFSK is a technique for transmitting digital data using multiple tones, extending the RTTY two-tone technique to many tones, usually, but not always, one tone at a time.

MFSK means Multi - Frequency Shift Keying, and should not be confused with MSK (Minimum Shift Keying). There are a number of different techniques, using concurrent (or parallel) tones, sequential (one after another) tones, and combinations of tones. MT-Hell can be either concurrent or sequential, DTMF tones used for telephone signaling are concurrent tone pairs, while Piccolo and Coquelet, although using tone pairs, are decidedly sequential.

MFSK transmissions have a unique sound, almost musical, which is why Piccolo and Coquelet received their names (Coquelet means rooster).

MFSK uses relatively narrow tone spacing, so remarkable data rates are achieved for a given bandwidth - 64 bps in a signal bandwidth of 316 Hz is typical. The following picture is a spectrogram of an MFSK16 signal (16 carriers) with a spacing of 15.625 Hz and operating at 15.625 baud. The transmission operates at 62.5 bps (about 80 words per minute!) and occupies about 316 Hz of bandwidth. The two black horizontal lines in the picture are at 1000 Hz and 1300 Hz, and the horizontal scale is about 20 seconds.

This short transmission contains about 120 letters. MFSK16 is always operated with FEC, so the text throughput is actually only about 42 WPM (31.25 bps).

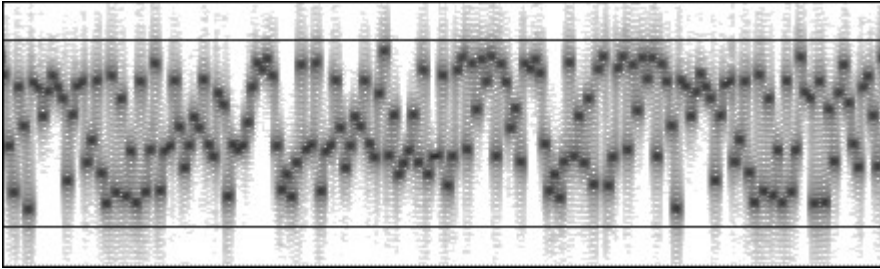

**Fig. 1. Spectrogram of an MFSK16 Signal**

### **Advantages**

MFSK has several performance advantages:

- High rejection of pulse and broadband noise due to narrow receiver bandwidth per tone
- Low baud rate for sensitivity and multi-path rejection - data bit rate higher than symbol baud rate
- Constant transmitter power
- Tolerance of ionospheric effects such as doppler, fading and multi-path

Most important of all, with an MFSK system, the error rate improves as the number of tones is increased, so with as many as 32 tones the performance is unrivalled. With PSK systems the opposite is true.

### **Disadvantages**

Let's be fair - there are disadvantages to MFSK! The main disadvantages are related to the narrow spacing and narrow bandwidth of the individual tone detectors - drift can be a problem and accurate tuning is essential. Good tuning indicators and AFC are necessary at the slower speeds. It is important that the radio transceiver be very stable, and also that it has very small frequency offset between transmit and receive (preferably less than 5 Hz).

MFSK also uses more bandwidth for a given text speed than a 2FSK or PSK system, but by the same token it is therefore more robust.

### **Alphabet Coding**

There are many ways to encode the alphabet from the keyboard for transmission. Perhaps the most common now is ASCII (ITA-5), but ITA-2 (as used by teleprinters) is common. MFSK16, like PSK31, is based on a Varicode, which, unlike most such alphabets, assigns a different number of bits to different characters, so that more frequently used characters have fewer bits and are therefore sent faster.

The number of bits per alphabet character therefore depends on the character frequency, just like Morse. For example:

Character Varicode  
space 100  
a 101100  
e 1100  
E 111011100  
Z 101010110100

Thus, the alphabet coding performance depends on the chosen code, and with a Varicode, even on the text sent:

Alphabet Bits/Char  
ITA-5 ASCII 10  
ITA-2 7.5  
Varicode ~ 7-8

The strength of the varicode is that the alphabet is essentially infinitely expandable. For example, all the

European accented characters are defined, and others have been added for control purposes, that are outside the character set. The MFSK16 varicode is not the same as the PSK31 varicode, although the technique is similar.

Another important advantage of using a varicode is that the stream of data can be much more quickly re-synchronized in case of errors, than is possible with other systems, and so a minimum of data is lost.

### Text Throughput

The user is most interested in the actual usable text throughput, which is specified in characters per second (CPS) or words per minute (WPM). Both depend on the alphabet used, and the number of words per minute depends on the average word size. In English this is taken for convenience to be five letters plus a letter space. So we can say that:

**Text Throughput (CPS) = User Data Rate / Alphabet Bits per Character**

**Text Throughput (WPM) = CPS x 60 / letters per word**

### Worked Example

Say we are using an MFSK system with 16 tones (16FSK), operating at 15.625 baud with FEC Rate = 1/2, and an ASCII alphabet using 10 bits/character. Then:

Symbol Rate = 15.625 baud

Channel Data Rate = 15.625 x log<sub>2</sub>16 = 15.625 x 4 = 62.5 bps

User Data Rate = 62.5 x 1/2 (FEC RATE) = 31.25 bps

Text Throughput (CPS) = 31.25 / 10 CPS = 3.125 CPS

Text Throughput (WPM) = 31.25 x 60 / (10 x 6) = 31.25 WPM

This will take place in a bandwidth little more than 16 x 15.625 = 250 Hz.

### Comparisons

Amateur Radio RTTY operating at 45.45 baud achieves 60 WPM with no error correction, and requires about 300 Hz bandwidth. 300 baud packet is error corrected, but is unsuited by its design to HF conditions, and rarely delivers better than 30 WPM, and often much less. Packet requires 1 kHz bandwidth. PSK31 operates at 31.25 baud, and in QPSK mode gives error corrected text at 31.25 WPM approximately. It has the narrowest bandwidth, less than 100 Hz.

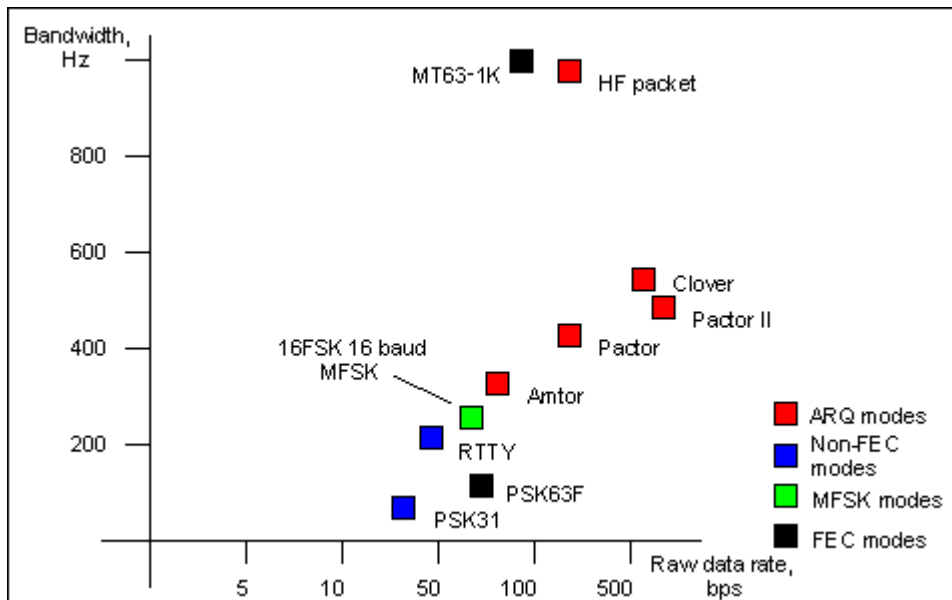

**Fig. 5. Graph showing raw data rate of various digital modes versus approximate bandwidth.**

In terms of performance, of the examples given, only MFSK16 and PSK31 are considered practical for DX QSOs. PSK31 often performs poorly on long path, and provides no improvement when the FEC is used, so is usually used without it. MFSK is virtually as sensitive as PSK31 in practice and is unaffected by Doppler. It is also less affected by interference, and offers effective FEC. These results are supported by ionospheric simulation tests.

## MFSK16

The new MFSK16 mode includes continuous phase tones and many other improvements, especially to the receiver. The mode is loosely based on Piccolo, but differs in a few important ways:

- The transmitted data is bit oriented, rather than character oriented.
- The fundamental signal is a single symbol, not a symbol pair.
- Error reduction coding is built in.
- Tone spacing and baud rates are divisions of 125.
- The transmitted tones are phase synchronous CPFSK.
- No symbol phase or other AM information is transmitted.

1. The system can therefore potentially transmit text and binary files, any alphabet including varicodes, and can use error coding.

2. The tones and baud rates (15.625 Hz, 31.25 Hz etc) are chosen to allow straightforward PC sound card sampling at 8 kHz sample rate.

3. This means the transmitter need not be linear. Using the receiver FFT, the transmitted carrier phase can be extracted, and from it the symbol phase is deduced. This technique is very fast and reliable.

Of course MFSK16 is computer oriented, rather than an electromechanical system, so will be easy and inexpensive to install, and easy to operate, with no performance compromises.

- Accurate tuning for transceive operation using "point and click" techniques
- Convolutional coded FEC (Forward Error Correction) with interleaver for error reduction
- FFT (Fast Fourier Transform) symbol filtering and detection
- Symbol sync recovery by measuring transitions or carrier phase in the symbol detector FFT
- Two signaling speeds with differing numbers of tones (but the same bandwidth) to suit conditions

The MFSK Varicode is slightly more efficient than others, since smaller codes are available. This in turn is because the combinations "000", "0000" etc do not need to be reserved for idle and can be used inside character bit streams. Only the combination "001" is forbidden, as this signals the end of one character and the start of the next. The speed on plain language text is almost 20% faster than using the G3PLX varicode. The average number of bits per character for plain text has been measured at 7.44, giving MFSK16 a text throughput of 42 WPM at 31.25 baud user data rate.

Note: Murray has an excellent website with much more information on MFSK16 and other related modes. This is an great resource for anyone interested in learning more about this fascinating new mode:

**MFSK, "The official MFSK website"** Murray Greenman, ZL1BPU. <http://www.qsl.net/zl1bpu/MFSK/>

## MFSK Operation

---

MFSK16 uses approximately the same bandwidth as 170Hz shift RTTY and so your MFSK16 transceiver settings can be roughly the same as those used for standard shift RTTY.

### Transceiver Settings

**Fine Tuning:** If your transceiver is equipped with a "FINE" tuning feature, always use that for digital mode tuning once you have found the general area of the signals, however, most of your adjustments can

be made in software, and not with the transceiver's VFO if you prefer. Some older rigs are really not stable enough for MFSK operation and will drift considerably off frequency.

**USB:** USB is the convention for MFSK operation in all bands. Either sideband can be used, but the sender and receiver must be using the same sideband, or one station must be inverted ( see: Inversion in the Configuration Topic).

**Filtering:** Optimum filtering depends on your transceiver's SSB filtering options and it's IF rejection characteristics. Wide filtering will enable you to work the largest spectrum without retuning your transceiver, but can also cause problems when there are strong adjacent signals. A narrow (RTTY or FSK) filter may help significantly with some radios and situations. Many transceivers do not have narrow filtering options while operating in SSB modes.

## MixW Settings

**Mode:** Click on the mode box in the status bar and select MFSK. Then click on the mode box in the status bar again and select "Mode Settings". This brings up the following dialog box:

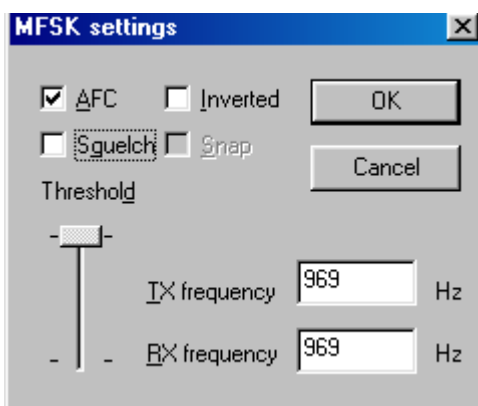

**TX and RX** frequencies are set to the location of your cursor is in the spectrum window. Keeping this around 1500 Hz, will keep your transceiver operating close to the center of its pass band.

**AFC**, which should always be set to ON for MFSK operation due to the critical nature of MFSK tuning.

**Squelch** and the **Squelch threshold** can be adjusted to limit garbage characters, but you can also miss characters by using squelch as well.

The MFSK tones can also be **inverted** by checking the Inverted box.

**Note:** This feature works differently in MixW than most other SoundCard digital programs, so please read and understand the information about [inversion](#) in the Configuration Topic.

## Tuning MFSK

You can easily recognize the sound of MFSK once you have heard it. It sounds a lot like RTTY, only with multiple, rather musical tones. The following tuning display shows the distinctive waterfall pattern of MFSK16:

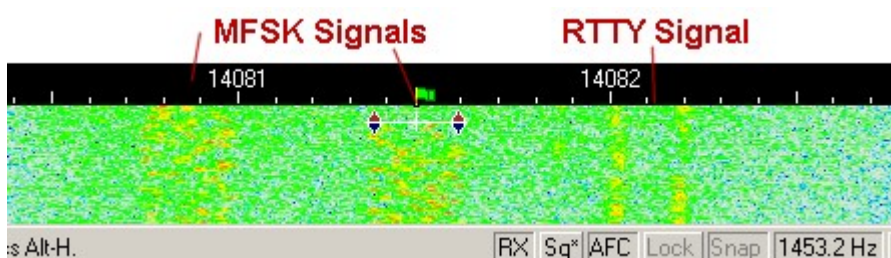

As you can see, the multiple MFSK tones are dispersed throughout the bandwidth of the signal while the

two distinct Mark and Space tones of the RTTY signal are at the edges of the bandwidth. You can also see that MFSK16 uses just slightly more bandwidth than the standard 170Hz RTTY signal. To tune an MFSK signal, click the cursor in the middle, then adjust it to either side by using the CTRL- Arrow keys until you start receiving text in the RX window, and the AFC locks onto the signal. Because of interleaving you may find that it takes a little longer to tune MFSK than RTTY or even PSK. You will also notice that the RX text will come in batches instead of a steady stream.

### Transmit:

To switch between transmit and receive press the Pause/Break key, click on the TX/RX box in the status bar, or select Options | RX, or Options | TX from the menu bar.

As with most of the other digital modes, It is possible to open multiple RX windows and switch the active window (the one you will be sending to) between them.

For these and other general operation techniques see the General Operation Topic.

## MFSK Image Mode

---

### Sending Pictures in MFSK:

While operating in the MFSK mode it is possible to switch to a narrow bandwidth image mode and send small pictures without the operators manually changing from the MFSK mode at either the sending or receiving station.

The pictures should be small, no larger than about 250 x 200 pixels. The operation is much easier if the picture is put in the MixW folder, but that is not required.

The sending station should inform the receiving station that a picture is about to be sent. Then the sending operator should select File | Send Picture and then choose B/W... or Color.... The following dialog box will open.

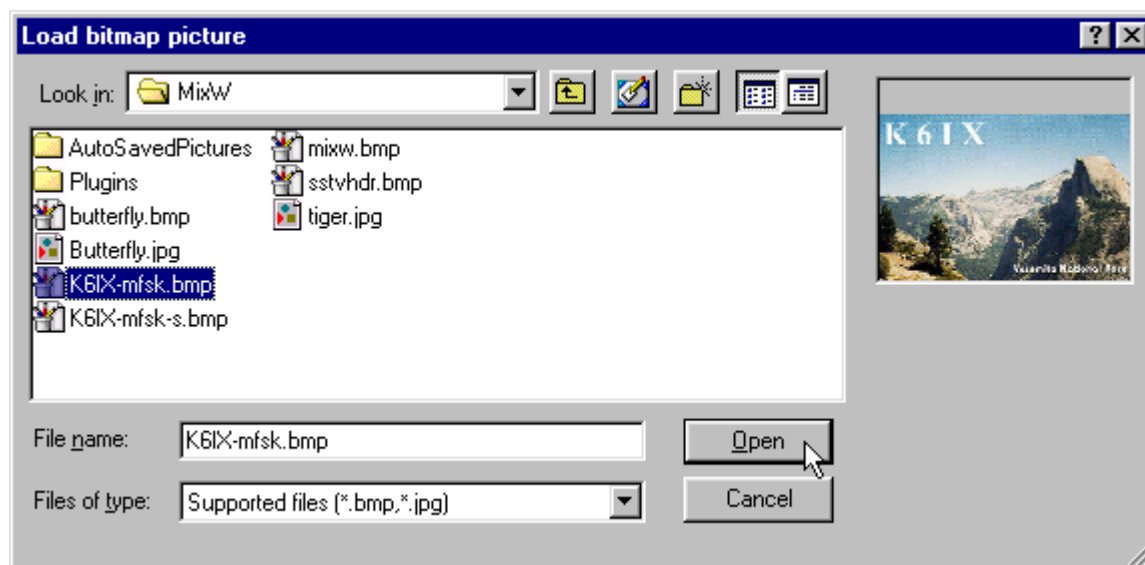

**NOTE:** B/W or Color applies only to the transmission method. Choosing B/W will result in a shorter transmission time than if the same picture is sent in Color.

Find and select the picture you want to send (.bmp or .jpg) and click open to start the transmission of the picture.

An icon appears in both the RX and TX windows of the sender's MixW screen while the picture is being sent. **Note:** If an "X" appears across the icon it means that MixW could not open the picture file because of the file type or because the file is damaged.

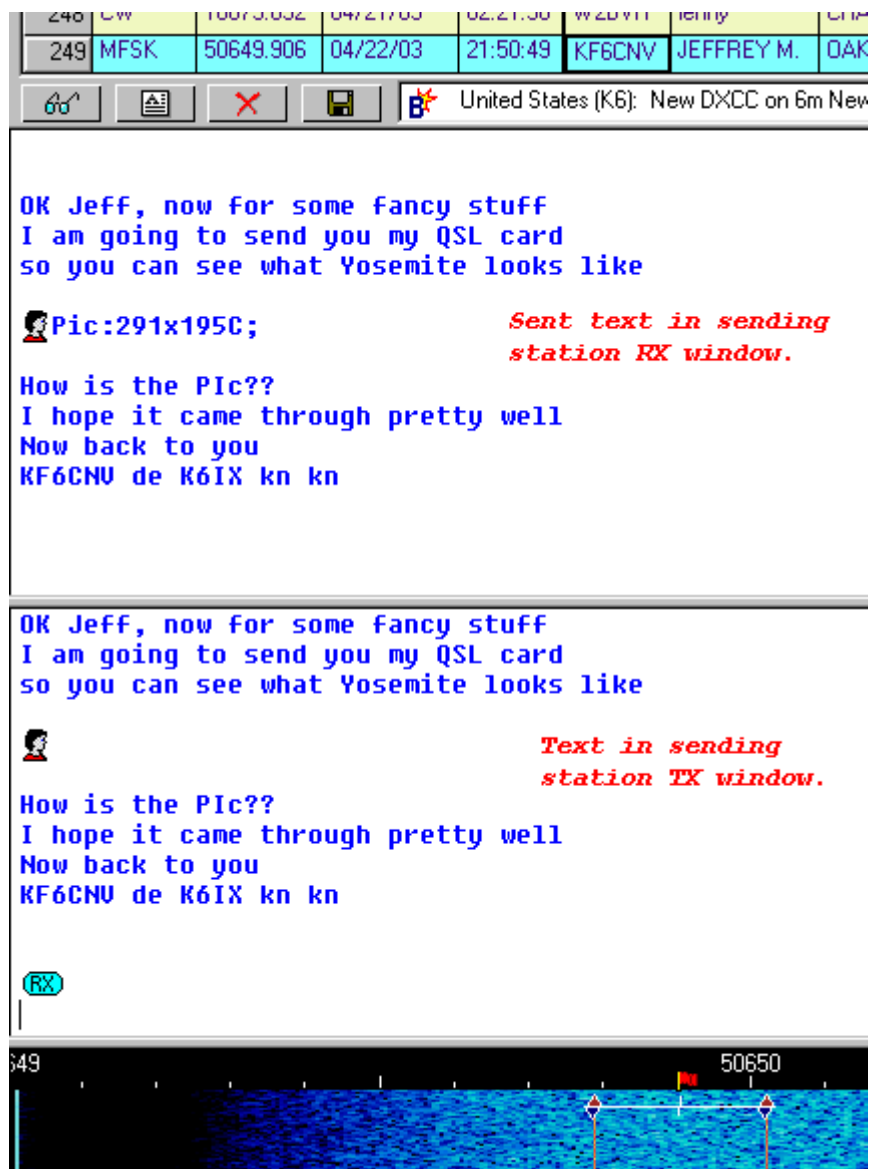

At the receiving station the same icon will be shown in the RX window, and the picture will be displayed in the upper left corner of the screen.





When transmission is complete the receiving operator can click on the Microsoft Icon in the upper left corner of the received picture, then select Save Picture..., and then select a location to save it.



On both stations MixW will switch back to the MFSK mode.

### Using macros to send MFSK pictures.

There are four macro commands that can be used for sending pictures in MFSK:

<PIC?N> - same as selecting File | Send Picture... | B/W...

opens dialog box to select picture file, sends in black and white

<PIC?N%C> - same as selecting File | Send Picture... | Color

opens dialog box to select picture file, sends in color

<PIC:filename.ext 00> - sends picture file in high resolution black and white

<PIC:filename.ext %C> - sends picture file in high resolution colour

**Throb**

---

**[THROB Introduction and Theory](#)**

**[THROB Operation](#)**

# Throb Intro & Theory

---

**THROB**, An experimental program using 9 tones and FFT detection developed by G3PPT.

The program code is now incorporated into MixW as mode Throb.

The Fast Fourier Transform Waterfall Display allows the display of signals that can barely be heard and this prompts ideas for harnessing the FFT waterfall display for communication purposes. An obvious example is slow CW whereby the dots and dashes are decoded visually, another is multi-tone Hell whereby different tones make up the dot matrix of characters and are sent simultaneously (MT Hell), or sequentially (SMT Hell). The author has developed a program called SLOWFELD, (available elsewhere on this site), which is essentially very slow speed Hellschreiber whereby the intensity of selected FFT bins is plotted. This is very effective but very slow at 2 chars/minute and like all the Hell methods, suffers from the disadvantage that the whole character has to be sent as a "picture" and there is no ciphering advantage of 'E' over 'Z' for instance.

The amateur fraternity has an enormous choice of methods for two-way QSO's taking place under normal conditions such as PSK31 and Hellschreiber and their developments. The THROB program is an attempt to push DSP into the area where other methods fail because of sensitivity or propagation difficulties and at the same time work at a reasonable speed.

At the outset, please be aware that this is at an early state of development and may change a great deal, or come to nothing at all.

The program uses a Pentium based PC equipped with Windows95 and a soundcard. The soundcard runs at 8000Hz and uses data blocks of 2048, 4096 or 8192 16 bit samples. For the three speeds of 4, 2 and 1 baud respectively. Pairs or single tones out of a palette of 9 in a 72 or 144Hz bandwidth are sent and received sequentially, each tone being 2048, 4096 or 8192 samples long and shaped as a semi raised cosine "throb" in that the leading and trailing quarters of the block are raised cosine shaped. The permutations of single and pairs of tones out of a palette of 9 allow for a rudimentary character set to be sent in a single pulse. For reception, the 72 or 144Hz band pass (obtained via FFT and reverse FFT filtering) is positioned centrally over the signal, and then the presence and position of the tones is our unit of coding. Synchronization of the reception process to the incoming "throbs" is used, and can now be set automatically.

The program is a development of a previous version, which used 5 tones in a 40Hz bandwidth with the characters being coded into the permutations of three successive tones. This was slow at 7 words per minute and also sideband sensitive, however it did prove that amateurs had equipment and were able to use it to tune within 3 or 4 Hz and, with the aid of AFC, to hold it. The latest version of the program has three speeds: 1, 2 and 4 baud, allowing for a data rate of 10, 20 and 40 wpm respectively, and is not sideband sensitive in that both LSB and USB possibilities are decoded and displayed separately with the nonsense version being ignored.

Auto synchronization has now been added whereby the program looks for two consecutive minima in the received signal intensity, the correct time apart and then sets the commencement of sampling at the first one.

AFC is available which can cope with a drift of 1Hz in 5 seconds or so.

There are still possibilities for improvement and fine-tuning of the program.

Since this work started it has become part of a general move towards trying MFSK modes on the amateur bands, MFSK having been neglected in the past. Murray, ZL1BPU has formulated a tentative specification for an amateur form of Piccolo and Nino, IZ8BLY with Murray has made enormous

advances in this direction with a program called STREAM which is now available with several modes. Nino has been able to incorporate error correction into his program. I cannot do this with my current number of tones.

One way or another, this looks to be an interesting area of development that should ultimately yield benefit to the radio amateur.

## Throb Operation

---

THROB is a narrow band mode, although not as narrow as PSK31. Your transceiver's set up should be essentially the same as used for PSK31. See PSK31 Operation to review those recommendations.

Perhaps the first thing you will notice when tuning in THROB signals is the distinctive throbbing nature of the sound, and the next thing is that Throb is very slow compared with most of the other digital modes.

Select the THROB mode with Mode | THROB, or by clicking on the Mode box in the Status Bar and selecting THROB. Then select Mode | Mode settings. This will bring up the following dialog box:

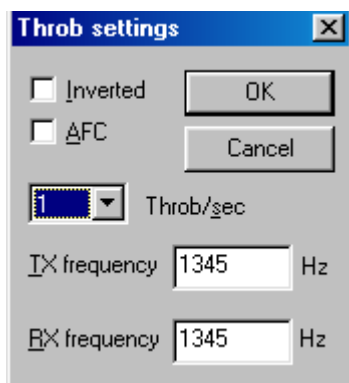

The TX and RX frequencies show the location of your cursor is in the spectrum window. A setting of around 1500 Hz is recommended, which keeps your transceiver operating close to the center of its pass band. THROB rate is selectable (if you don't see what you want in the drop down box, any number can be typed in).

**AFC** can be **on** to assist in tuning the THROB signals.

**Inverted** when clicked will invert the positions of the frequencies. This can be used if you are operating on the opposite sideband from the station you are trying to copy. If you appear to be tuned into a strong signal and are only copying garbage, try clicking **Mode | Inverted**, or **clicking the box in the Throb settings**. You may find the station start to print 100 percent as a result. See [Inversion](#) in the Configuration Section.

Here is a screen shot of a Throb signal on the waterfall display:

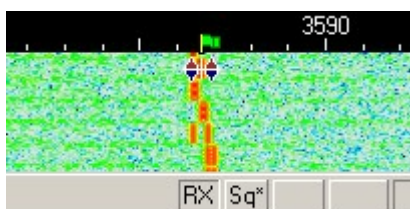

As you can see Throb uses the two diamonds with a bar between., and that they are substantially closer

together than any of these other modes.

### Receiving Throb

Tune in a Throb signal by pointing right in the center of the tracks with the mouse and clicking the left mouse button. The text being sent by the station will then appear in the Receive Window. The diamonds will move together to track and tune Throb QSOs.

### Transmitting Throb

To transmit to a station, first tune it in as indicated above. Type outgoing text in the Transmit Window. Press the T/R button, and the text in the Transmit Window will be transmitted. You can continue to type, and that text will also be transmitted. As it is being transmitted, text in the transmit Window will also appear in the Receive Window. To stop transmitting, press the T/R button (or one of the other toggles) again. Pressing ESC will abort transmission and return MixW to receive mode, but the last several characters typed will not be transmitted.

## FSK

---

### FSK Theory and Operation

### FSK31 Theory & Operation

---

The main difference between FSK31 and PSK31 is that FSK31 represents a 90/270 degree phase shift (DBPSK) instead of the 0/180 pair used in the original BPSK31 by G3PLX.

FSK31 is not as vulnerable to over modulation as PSK31. FSK31 is Nick's solution to cleaning up the QRM caused by careless over modulation of PSK31 signals. Here is a comparison of PSK31 and FSK31 using a spectrum bandwidth at the -40 db level:

		PSK31	FSK31
Clean Signal:	Idle	31	31
	Random	80	60
Light Distortion:	Idle	220	124
	Random	220	93
Heavy Distortion:	Idle	500+	160
	Random	500+	93

Random = random sequence of characters.

Operating FSK31 is essentially the same as operating PSK31

# MT63

---

## MT63 Introduction and Theory

### MT63 Operation

## MT63 Intro & Theory

---

By Murray Greenman, ZL1BPU

MT63 is a DSP based advanced HF mode for Amateur Radio, intended to provide high performance keyboard - to - keyboard conversational operation on HF bands under poor conditions. MT63 utilizes a number of revolutionary ideas, and is technically very complex. MT63 is no more difficult to operate than RTTY, and can be easy to tune. It also provides much better performance on HF than most other modes. The specialty of MT63 is its performance when conditions are both weak and unstable.

### **Simple Description**

By encoding the data to transmit (what you type on the keyboard) in a complex way, using 64 different modulated tones, the MT63 developer Pawel Jalocho, SP9VRC, has been able to include a large amount of extra data in the transmission of each character, so that the receiving equipment can work out, without any doubt, which character was sent, even if 25% of the character is obliterated. This technique is called Forward Error Correction. Other modes use FEC (for example AMTOR mode B uses a simple FEC technique), but MT63 has other advantages. Unlike most HF modes where a character can be lost or changed into something else by a single noise burst, MT63 is inherently very robust, because each character is spread over many tones (to avoid interference such as other radio transmissions) and over several seconds (to avoid bursts of noise, such as lightning). On each tone, the transmission data rate is also fairly slow, which suits the nature of ionospheric disturbances. Despite the low data rate, good text speed is maintained because the text is sent on many tones at once. The system runs at several different speeds, which can be chosen to suit conditions, but 100 WPM, much faster than you can type, is typical.

MT63 sounds unusual, (it sounds like a roaring noise) but the performance is spectacular. There is no connection process, as in AMTOR, Packet or PACTOR. Some users maintain that under poor propagation conditions (excessive fading) MT63 works better than either PACTOR II or Clover. Under good conditions the performance advantages are less obvious. The convenience advantages remain, no matter how good the signal - the mode is suited to nets and random QSOs, as no link need be established. MT63 is also far more immune to interference and deliberate jamming than any of the more conventional modes. Changeover from transmit to receive and vice-versa is slower than most modes.

There are disadvantages to MT63. First, the mode is broad (see below) and quite aggressive, i.e. it causes interference to other modes, but itself is little affected by other modes. Also, because of the delay through the error correction and interleaving processes, it is not possible have quick turnaround "slick" QSOs. In other words, operation is clumsy.

### **About Wide Modes**

Modes like MT63 are quite different from the traditional Amateur digital modes, in fact even other new digital modes. MT63 is both wideband and relatively slow, gaining performance enhancement by spreading the signal in time and space, although it is not a "spread spectrum" mode. There is some controversy surrounding indiscriminate use of modes such as MT63, because they appear to generate wider signals for a given data rate than other modes. Choose your operating times and frequencies with

care! (In other words, 20 meters when the band is open and crowded is not appropriate).

## MT63 Operation

---

For MT63, you must tune with your transceiver's VFO . The tuning indicators cannot be changed with the mouse. Their location can be changed, however, by selecting Mode | Mode Settings, while in the MT63 Mode. This brings up the following dialog box:

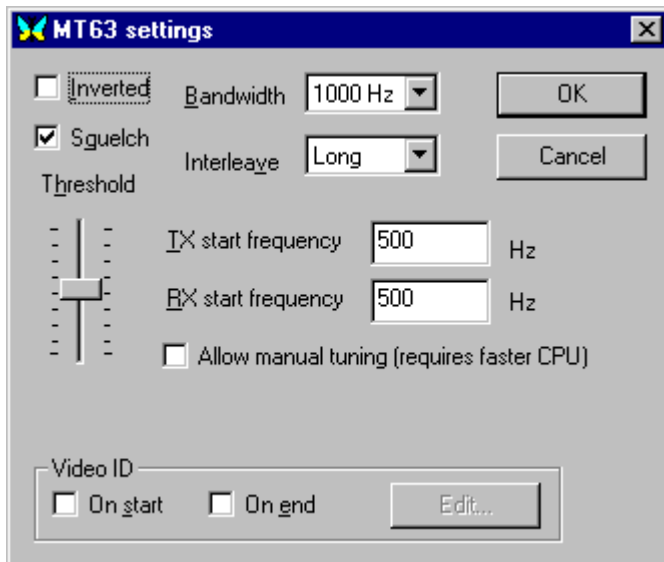

The TX and RX start frequencies determine the location of your tuning indicators on the waterfall display. These should be the same unless your intention is to operate "split", or your transceiver's TX and RX frequencies are out of alignment with each other and you want to compensate for that here.

### Transceiver Settings

**Fine Tuning:** If your transceiver is equipped with a "FINE" tuning feature, always use that for MT63 tuning once you have found MT63 activity. Some older rigs are really not stable enough for PSK31 operation and will drift considerably off frequency, but because of the wider bandwidth, they are often fine for MT63.

**Pre-Amp:** This can be on or off depending on the operating conditions. It can help when working weaker stations in certain situations, but can also make things worse if there are strong adjacent signals.

**USB:** Almost all MT63 operators use USB transmissions. **Note:** While using the CAT features, MixW automatically adjusts tones depending on which sideband you are operating on. If you are not using CAT, MixW needs to know which sideband your operating on to set the inversion correctly. (See the discussion bellow under inversion).

**Filtering:** Optimum filtering depends on your transceiver's SSB filtering options and it's IF rejection characteristics, however MT63 is generally 1000Hz wide (MixW allows 500Hz and 2000Hz MT63 as well). This is much wider than the other digital modes, with the exception of FAX and SSTV. In general your SSB phone filtering will be the best choice for MT63 operations.

**Power:** This of course depends on conditions. MT63 uses a much wider bandwidth than the PSK31 modes, and so it will require higher power to deliver the same overall signal to the receiving station. Never use more power than you need to for any given situation.

## MixW Settings

As mentioned above, the TX and RX start frequencies can be set to determine the location your cursor in the spectrum window. A location between 500Hz - 1500 Hz, will keep your transceiver operating close to the center of its pass band.

**Bandwidth:** Bandwidth is selectable as well. Most MT63 uses a bandwidth of 1000Hz.

**Squelch and Threshold** can be used and adjusted to suite your operating preferences.

**Interleave:** Interleave must be adjusted according to bandwidth: try the following combinations:

Bandwidth Audio Range Interleave/char

500 Hz 500 - 1000 Hz Long

1000 Hz 500 - 1500 Hz Short

2000 Hz 500 - 2500 Hz Very Short

**Use 8-bit encoding and Escape Char:** Original MT63 supports only 7-bit encoding, which does not allow the use of international characters. 8 bit encoding allows an extension to MT63 protocol where each extended character (with code > 127) is represented as two 7-bit characters: the escape symbol and symbol code minus 128. To allow these charectors check the 8-bit encoding and set the Escape Charector to 127 (the defaulte value).

## Video ID and options

This is an unusual feature used to transmit a Video ID, which is visible on the waterfall display. See SSTV for details on Video ID.

**Inverted** when clicked will invert the tones to match a station. If you appear to be tuned into a strong MT63 signal, which is tuned within your cursors, and are only copying garbage, try clicking **Mode | Inverted**. You will often find the station start to print 100 percent as a result.

**Note:** This feature works differently in MixW than most other SoundCard digital programs, so please read and understand the information about [inversion](#) in the Configuration Topic.

## Receiving MT63

Tune your transceiver's VFO until the MT63 signal appears within the tuning indicators as shown here:

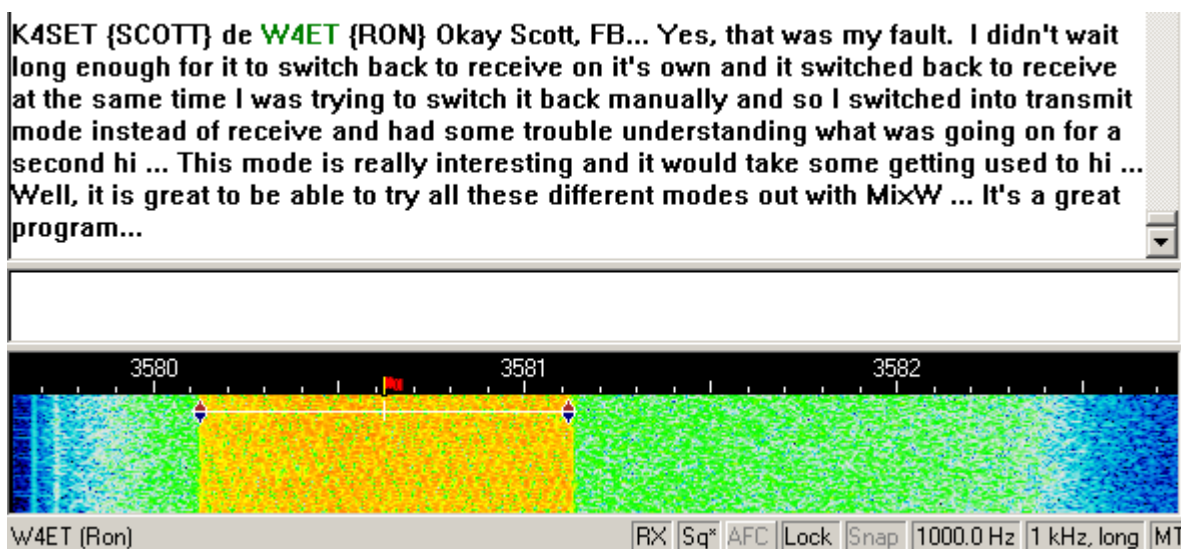

Text should decode and appear in the RX window. If the MT63 signals you're attempting to tune are too wide or too narrow to line up with your tuning cursors, you may need to change your bandwidth setting as described above.

## Transmitting MT63

To transmit to a station, tune it in as indicated above and type your outgoing text in the Transmit Window. Press the T/R button and the text in the Transmit Window will be transmitted. You can continue

to type, and that text will also be transmitted. As it is being transmitted, text in the transmit Window will also appear in the Receive Window. To stop transmitting, press the T/R button again. Pressing ESC will abort transmission and return MixW to receive mode, but the last several characters typed will not be transmitted.

## SSTV

---

### SSTV Introduction and Theory

### SSTV Operation

## SSTV Intro and Theory

---

**By Chuck Schied, Jr., W3OHV**

SSTV is facsimile, and facsimile is a method of producing a picture a line-at-a-time. Newspapers and the wire press (e.g., AP, Reuters, UP) use facsimile for photos and text via wire and radio. Facsimile uses a line scanning system. More lines, hence more time taken to send them, creates sharper better-defined images. Line scanning is a very old concept. It is used in infrared mapping and military reconnaissance. Artists have used the concept to copy graphic images freehand. Ham Radio Video is a compromise system that runs fast enough to produce attractive -- sometimes very beautiful -- pictures.

Slow Scan pictures used in amateur radio can be sent in a variety of time formats. Simple black-and-white photos of low resolution can be sent in 8 1/2 seconds. Good quality pictures in B/W or Color can be sent in one to three minutes. Excellent pictures in Color can be sent in about four minutes. Standard resolution of a picture today is a 640 width x 480 height pixels with 24-Bit color. 24-Bit color (also known as Truecolor) is able to reproduce up 17 million different hues. These are minute variations of eight basic colors like red, yellow, green, blue, white, black, magenta, and cyan. Today's Slow Scan pictures using formats like Scottie #1 or Martin #1 are quite stunning! There are fifty or more formats created by many different programmers.

Slow Scan is actually faster than facsimile but slower than standard Television! You can use the longer formats like Scottie DX or WRASSE 180 (4-5 minutes) and receive beautiful pictures even in poor receiving conditions. You may have heard SSTV on 14.230-233 MHz or 7173 MHz. You can learn a lot by listening. Don't invest in Slow Scan until you have learned something about it from people who know what they are talking about. Newcomers have many erroneous ideas about the Mode and will be poor tutors. Old-timers who own ROBOTS are of little help if they have not become expert users of PCs and use the SSTV PC Programs routinely.

### **Where Slow Scan Video is Today**

About 1992-93, as the Personal Computer began to appear in ham shacks, Slow Scan was no longer an expensive, experimentalist, activity. Prior to that time an expensive converter built by ROBOT RESEARCH Company was the only way to receive and send Slow Scan. After several years of PC programs, written by radio amateurs who were also involved in programming, the mode increased in popularity as new and better PC performance became available, especially in CPU speed, better color, and sharper resolution.

For additional SSTV information vist:



<http://www.qsl.net/kb4yz/>

and

<http://www.hffax.de/html/net.htm> for frequencies to use.

## SSTV Operation

---

### MixW and SSTV

Nick does not intend that MixW will compete with MMSSTV, ChromaPIX and other dedicated SSTV programs. It does not have extended services like templates or diagonal texts with gradient fill, however it does allow you to make occasional QSOs. It has the ability to manually correct for phase and slant. It lets you quickly type and place text over transmitted images. Macros can be used for frequently typed words. This mode in MixW is intended as a tool for experimenters, and for those who want to save time by not having to switch to a different program for SSTV operations..

Selecting SSTV from the mode menu or the status bar brings up the following window:

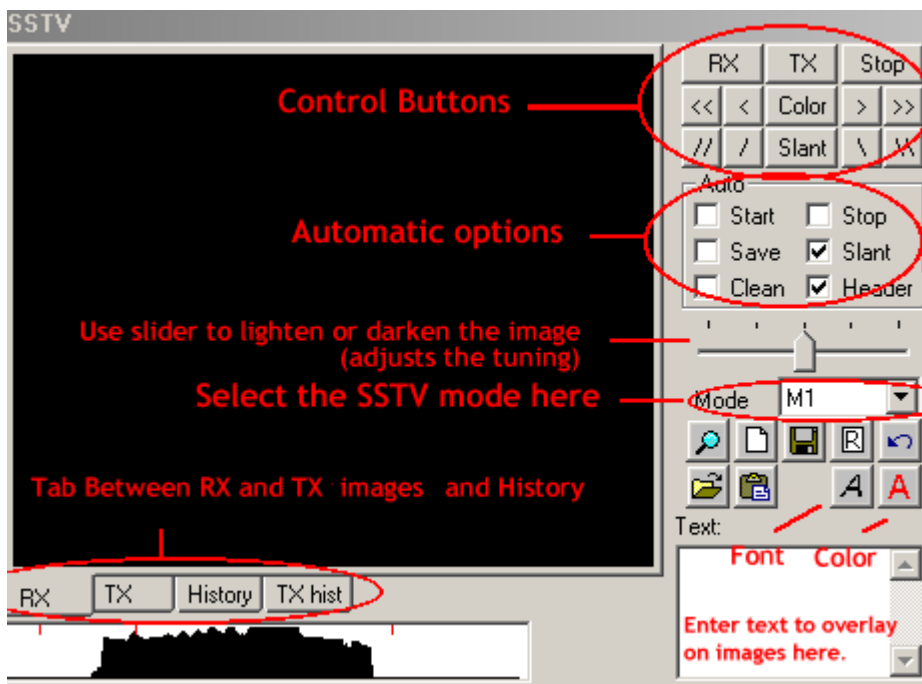

The control buttons are used as follows:

RX starts the receive image function using the mode selected.

TX will start the transmission of the image loaded into the TX window using the mode selected.

Stop will stop the RX or TX functions.

COLOR and horizontal location can be adjusted using the [<<], [<], [>], [>>] and the Color buttons.

Slant is adjusted using the [\,/] and Slant buttons.

You can also select which automatic options you want by using the Auto check boxes.

The RX, TX, History, and TX hist Tabs are used to select what is displayed in the image window.

To Load a TX image click the open folder icon and select the image from your files (the size should be 320x256x24).

To Save a RX image click the disk icon and select the location and name of the file to save.

If Auto Save is ticked the pictures will be saved to the directory specified by the

AutoSavePath=C:\radio\mixw311h\AutoSavedPictures

in the MixW2.ini file [SSTV] section.

To Load a picture from the clipboard, click the clipboard icon.

Text can be placed on the TX screen by selecting the text color and font using the indicated icons, then entering the text in the text window. Click the left mouse button in the TX window and move the text to where you want to place it, then release the mouse. The text can be placed during transmission.

The following screen shows a .BMP file that has been edited with text using the above procedure:



RX slant/phase correction:

Draw a line over the border of the picture. A left mouse click on the border corrects the phase only; the slant will not be changed. A right click can be used to move the picture up. The slant and phase can be corrected during receive.

Holding the Shift+slant keys saves the current slant correction, and this value will be used while transmitting or receiving the next pictures.

### Modes

All the common SSTV modes are available for both TX and RX. Pull down the Mode text box for a

complete list.

## Header

By default MixW uses sstvhdr.bmp as a header. Edit this file if desired to change the header, or select another file by holding the Ctrl key and clicking the Load icon. Hold shift during the load or clipboard operations to eliminate header. Just remove sstvhdr.bmp if you do not want any header.

Here is a tuned SSTV signal in the Waterfall display:

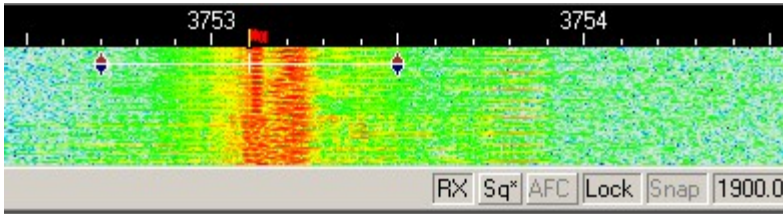

This yielded the following image from my friend Ron, W4ET:



## Soundcard calibration

It is most important your soundcard is fully calibrated. The MixW installation provides a very good tool for soundcard calibration of both receive and transmit without recourse to using an external receiver (see [Basic Set Up](#)) although it is slightly time consuming. Alternately use the procedure below.

## SSTV Calibration using WWV

The WWV mode can be used to calibrate the soundcard while receiving WWV or RWM signals. RWM broadcasts from Moscow, and WWV broadcasts from Colorado and Hawaii in the USA. For more information check:

<http://www.irkutsk.com/radio/tis.htm>

<http://tf.nist.gov/stations/iform.html>

RWM time marks are transmitted on 4996, 9996, 14996 KHz. Tune your TRCVR to 4994.100, 9994.100, 14994.100 (USB). When the RWM signals are tuned:  
Uncheck ALL Auto boxes

Select the WWV mode from the dropdown mode menu

Tune your receiver so the tuning indicator is on the signal as shown below.

Click on the RX button

You will see black and white bar patterns

Adjust the slant until the edges are straight

The image will depend on the timing intervals, but the edges should be straight in any case. It should look something like this:

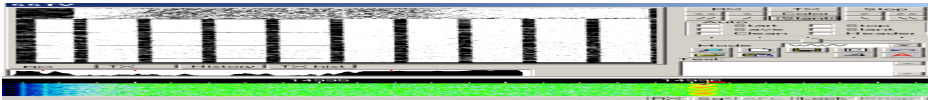

If you cannot find the time mark signals from RWM, tune about 1 khz above the WWV signal (10001, 15001, or 20001 khz) and click on receive. You should get a screen that looks something like this:

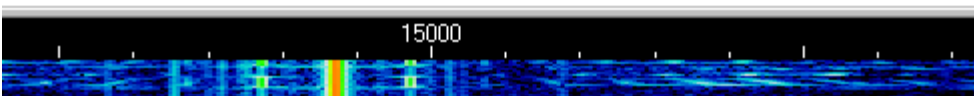
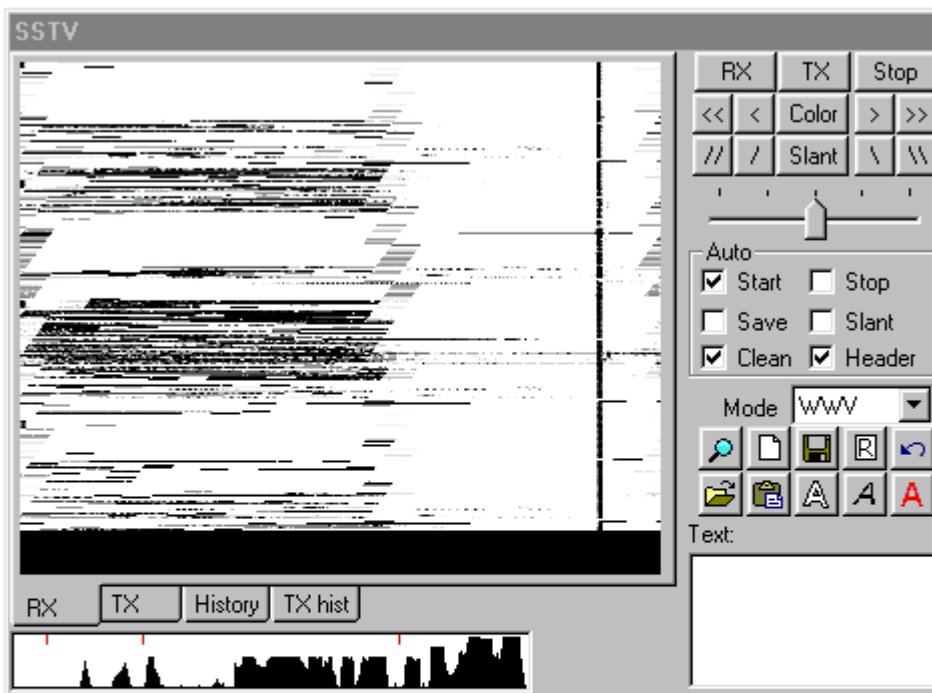

Adjust the slant as described above until the thin vertical line is parallel with the edges of the window.

This SSTV slant correction can be moved to the soundcard sample rate correction to let other modes use that correction as well. To do this select the SSTV settings dialog from the Mode Menu and click on the "Go" button:

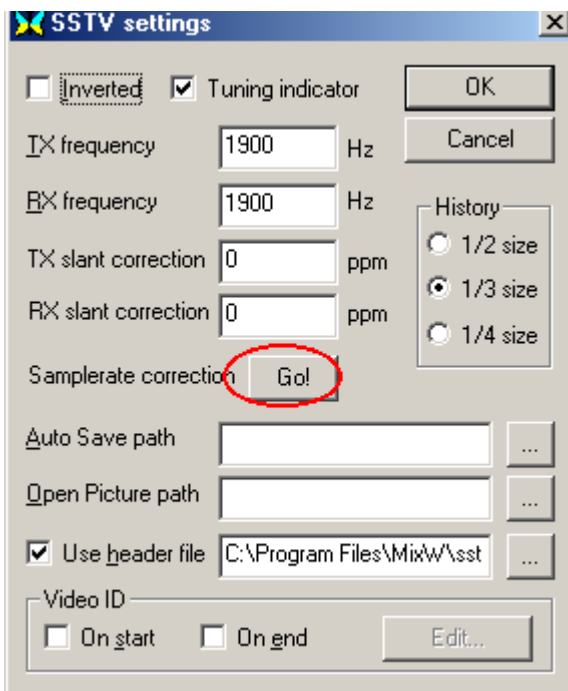

**NOTE:** The procedures described above will calibrate the soundcard for RX. Some soundcards have separate RX and TX corrections. To check your TX correction, start with the same correction you have calibrated for RX. Then send to a station with a soundcard calibrated for RX. If your transmitted pictures do not require slant correction by the receiving station your soundcard is corrected for TX. If your transmitted pictures do require slant correction you will need to experiment with changes to the TX slant correction (in the SSTV settings dialog) until they are correct.

### SSTV Settings

You can also select other SSTV options from above dialog.

**The Tuning indicator check box** toggles the SSTV tuning display at the bottom of the SSTV window.  
**The TX and RX frequency settings** locates your tuning indicator on the waterfall display and your radio's pass band. These cannot be moved with a mouse click on the waterfall display, but must be set here.

**TX and RX slant correction** are best left to the WWV calibration process, which automatically enters the correction here.

**The GO button** sends these corrections to the soundcard sample rate correction settings.

**Selecting the history size** determines how many images can fit in your History Tabs.

**Setting the Auto Save and Open Picture paths** will make saving and loading images much faster and more convenient.

**Check the use header box** if you want a header added to each TX image, and select the image you want to ad.

### Video ID

This is an unusual feature used to transmit a Video ID, which is visible on the waterfall display as follows:

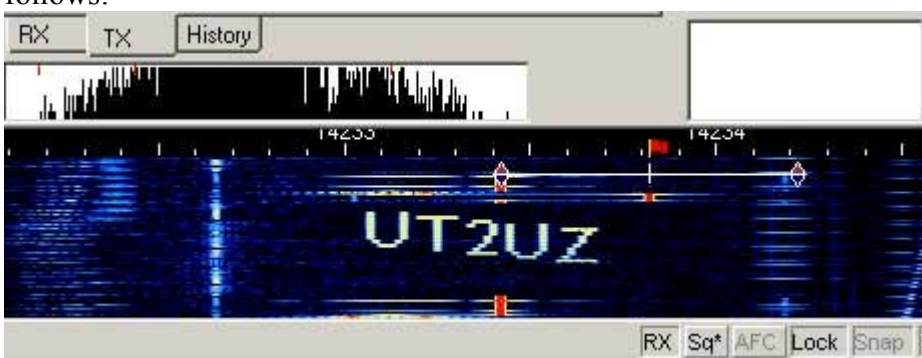

A simple editor is included. Since the power is divided by all points and transmitted at the same time, do

not make long horizontal lines. Try the VID samples butterfly.bmp and mixw.bmp, which are located in the MixW directory, or make your own. Select when to transmit your video (start, end, or both) and then click the Edit button, which will bring up the following dialog:

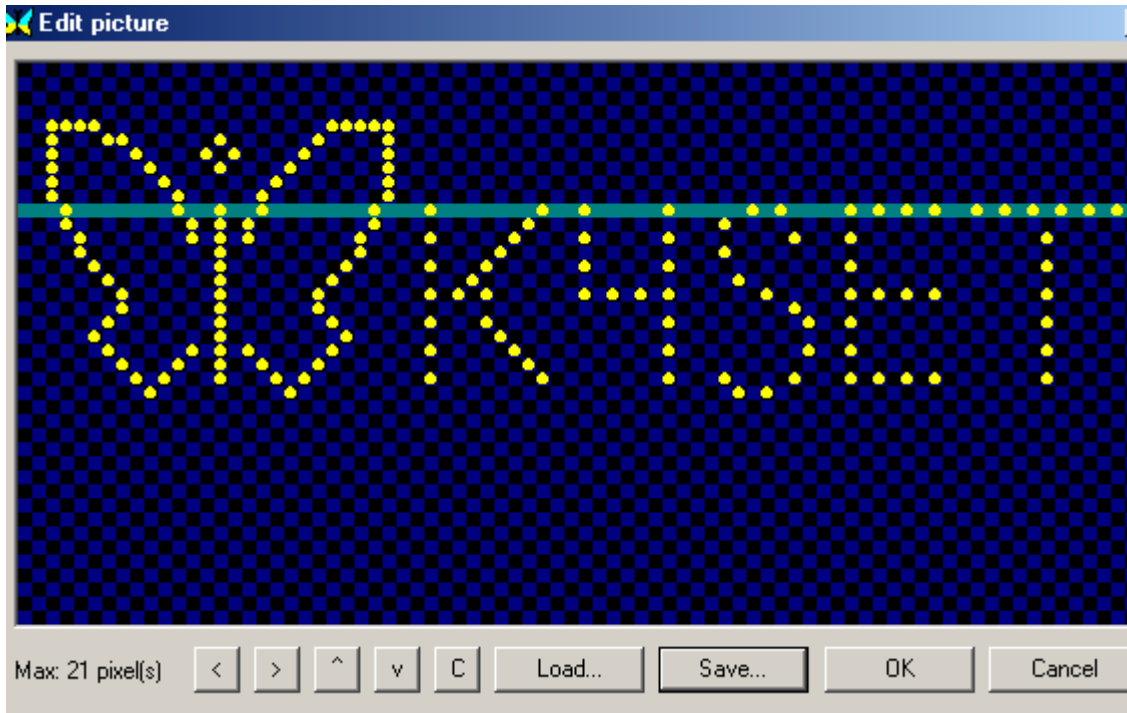

I made this VID by first loading the butterfly.bmp, and then clicking on the pixels to add my callsign to it. I then saved this to a new file and selected it as my VID.

### Troubleshooting SSTV

In case of trouble with dropping receive or transmit, the following hints may help.

Play with following lines in the mixw2.ini:

- Section

```
[Device 0 Setup]
```

```
m_iBufRxNum=48
```

```
m_iBufRxSize=256
```

```
m_iBufTxNum=48
```

```
m_iBufTxSize=256
```

declares 48 buffers, 256 bytes each to use for sound operations.

If we use sound card at 11025 sps, total length equals to

$48 * 256 / 11025 \sim 1.1$  sec. I.e. a little less that a second is

reserved for unexpected Windows delays. We can increase the time by enlarging buffer sizes or increasing the number of buffers.

Increasing the buffer size in parallel with decreasing the number of buffers may reduce system load a little:

```
m_iBufRxNum=24
```

```
m_iBufRxSize=512
```

```
m_iBufTxNum=24
```

```
m_iBufTxSize=512
```

- Changing the task priority. Look for following section in the MixW2.ini:

```
[Priority]
```

```
MainThread=0
```

```
Class=32
```

These values are by default, defining standard priority.

Try

```
Class=128 (HIGH PRIORITY)
```

or

Class=256 (REALTIME PRIORITY)

This will definitely help in multitasking environment, and let you work with other programs at the same time, but it may hang slow PC.

Also you may play with increasing the main thread priority:

MainThread=1

or

MainThread=2

or

MainThread=15

I could set

Class=256 (REALTIME PRIORITY) and MainThread=15 on my C366 under W2000 and both SSTV TX and RX worked great while I was opening PhotoShop, compiled next update etc.

Also you may play with following numbers in [SSTV] section of MixW2.ini

FilterLength=4 May be increased. I use the value of 64 on my C366.

This value defines the number of taps used for the

FOR filter (actually the number of taps is FilterLength\*2+1).

Dec=5 Decimation rate. May be decreased to 4 or 3.

I do not recommend to set it less than 3.

## Hellschreiber

---

### Hellschreiber Introduction and Theory

### Hellschreiber Operation

## Hellschreiber Intro

---

By Murray Greenman, ZL1BPU

### **Feld-Hell**

Hellschreiber was patented in 1929, and is still in use today using the original format. Hellschreiber was the first successful direct printing text transmission system, and was very popular at a time when teleprinters were complex and expensive (the Hell receiving mechanism had only two moving parts). At first the Hellschreiber was mostly used for landline press services, which continued well into the 1980s. A military version was used by the German Condor Legion during the Spanish Civil War (1933). During WWII, Hellschreiber was widely used for field portable military communications, for which it proved to be very suitable because the equipment was simple and robust. Today we use the term "Feld-Hell", or "Field Hell" for this system, to help differentiate it from the slightly different landline press systems.

Each character of a Feld-Hell transmission is portrayed as a series of dots, in a matrix, just like the printing of a dot-matrix printer. The dots are sent one at a time, rather like Morse code. Feld-Hell transmits in the following order - up each column from bottom to top, then up each successive column from left to right. The following picture shows a fragment of text "BCDE", depicting the order in which the dot elements are printed. Each of the dotted rectangles represents a potential dot location, and is identified by a locating letter/number. The transmit order therefore is A1, A2, A3... A7, B1, B2... etc.

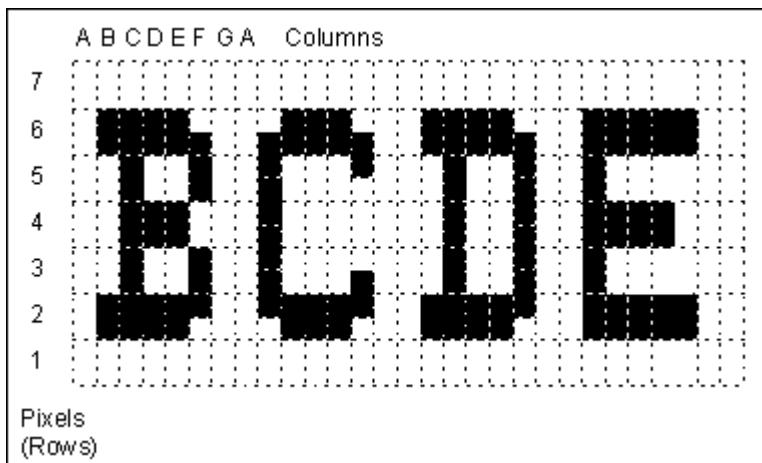

In this picture, the dotted rectangles depict individual dot locations in the matrix. There are blank, untransmitted picture elements (pixels) at the top and bottom of each character, and between characters. These are depicted as empty white rectangles. The transmitted (key down) pixels are shown black. Looking at the above diagram, it is easy to see that the transmitter duty cycle is quite low (about 22%). Another way of saying this is that the peak-to-average ratio is very high, which is important for good readability in noise. 150 characters are transmitted every minute. Each character takes 400ms. Since there are 49 pixels per character, each pixel is 8.163ms long. The effective baud rate is  $1/8.163\text{ms} = 122.5$  baud, and the throughput is 2.5 characters/sec, or about 25 WPM.

The original Feld-Hell equipment, and the best software implementations, transmit two pixels (each half height, or half the duration) for every pixel shown in the diagram, thus improving the vertical resolution. If you look carefully at the above diagram, you can see how this comes about without increasing the signal bandwidth. Rudolf Hell designed the font so that a single half-height pixel is never transmitted. For example, the right side of the "B" has enhanced resolution achieved by slipping the timing of the full-height pixels by half the height of one pixel. Three half-height pixels are transmitted without a break, so the bandwidth is not increased.

Another important reason for the restricted bandwidth design, while providing well-defined characters, was that this technique ensured that pulses to the radio transmitter were never less than 8ms. Shorter (half-pixel) pulses could be severely distorted by the slow rise-time of the transmitter, and as a result, cause excessive bandwidth or fail to energise the mechanical print hammer in the receiver.

The output of the wartime Feld-Hell machine was a 900 Hz keyed audio tone, sent on a telephone line or to a transmitter modulator, for example an MCW transmitter. It was possible in some models to separate the keying contacts for direct keying of a CW transmitter. Feld-Hell is therefore amplitude keyed, just like Morse, as CW or MCW. Each pixel of a dot matrix character is sent in a fixed pattern as a CW dots. Where there is no black dot, nothing is sent. Feld-Hell is in reality a simple facsimile mode. The early press system, F-Hell was identical except that it ran at 245 baud (5 characters/sec). An asynchronous variant, GL-Hell, (used by land-line machines) utilised a fixed start block of pixels at the left of each character, which provided character based synchronism, but this method has no advantage to Amateurs. An excellent article describing the traditional mechanical method of transmitting and receiving Feld-Hell appeared in Ham Radio Magazine, December 1979. An article which describes the Hell font and includes other useful information was printed in Radcomm, April 1981. The actual machine described by the late G5XB in that article is now in the possession of Ian G4AKD. The Siemens A2 war-time machine is also described in detail on the Feld-Hell History page.

For more information including a summary of the different Hell formats, see: [Murray's Website on Hell modes](#).

## PERFORMANCE

Feld Hell performs very well where the path has reasonable stability (little fading) and where the signal level is equal to the average noise or better. If gray-scale reception is used, performance at low signal to noise is much better. Feld-Hell is reasonably immune to interference, but can be badly affected by on-



frequency carriers or Morse.

## Hellschreiber Operation

---

Hellschreiber is a unique mode. Some would argue that it is not a digital mode at all. Still for our purposes, because we are certainly using digital techniques to operate Hellschreiber, we will call it a digital mode. It has more of a clicking, or chirping sound than the other, more recent digital modes. Receiving Hellschreiber text is more like receiving a FAX image. The characters you receive and transmit are actually pictures of characters.

Hellschreiber is another narrow band mode, like PSK31, and will benefit from the same transceiver settings. To review these settings please see the PSK31 Operation topic.

First switch to the Hellschreiber mode by selecting Mode | Hellschreiber, or by clicking on the Mode box in the Status Bar and selecting Hellschreiber. Next bring up the mode settings by selecting Mode | Mode settings. This will bring up the following dialog box:

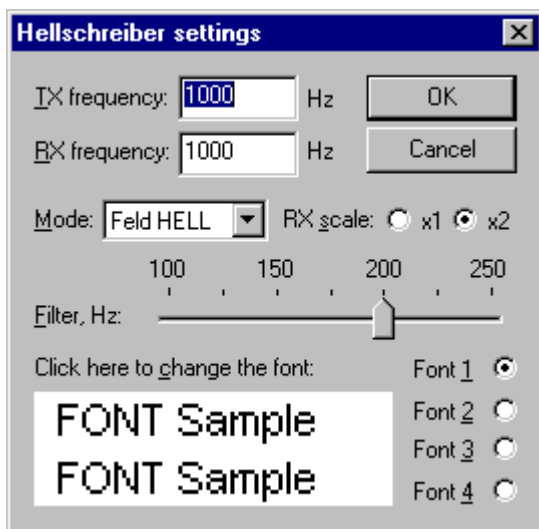

The TX and RX frequencies show the location of your cursor in the spectrum window. The best frequency is around 1500 Hz, which keeps your transceiver operating close to the center of its pass band.

**Mode:** The drop down box gives a choice of 3 sub-modes:

Feld HELL - The sub mode this description refers to.

FM 105bd - See [FM hell description](#). FM245bd - For FM Hell modes a two diamond cursor is used in the waterfall.

These modes may also be selected via the <SET SUBMODE:> macro.

**Filter:** You have a selectable software DSP filter width of between 100 and 250Hz. Varying this setting may improve your reception during differing conditions. A setting of 200Hz seems to work well overall.

**RX scale:** Setting the RX scale to x2 may help you decipher hard to read characters, but you will not be able to see as much text on each screen. Use x1 unless you're having trouble seeing the text at this resolution.

**Font Selection;** You can pre-select up to 4 different fonts by clicking the button next to each font # and then clicking in the font sample window. **This is the font you are transmitting, not receiving.** You will receive the font selected by the sending station.

Here is a screen shot of a Hellschreiber QSO:

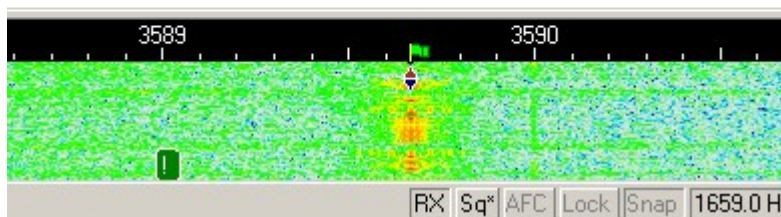

As you can see Hellschreiber uses the single diamond indicator like PSK31 uses, and the bandwidth is very narrow. Received text appears in double or triple lines. You can see more text on your screen by removing the log and other tool bars from the display.

### **Receiving Hellschreiber**

Tune in a Hellschreiber signal by pointing right in the center of the signal with the mouse and clicking the left mouse button. The text being sent by the station will then appear in the Receive Window.

### **Transmitting Hellschreiber**

To transmit to a station, first tune it in as indicated above. Type outgoing text in the Transmit Window. Click the T/R button, and the text in the Transmit Window will be transmitted. You can continue to type, and that text will also be transmitted. As it is being transmitted, text in the transmit Window will also appear in the Receive Window. To stop transmitting, press the T/R button again. Pressing ESC will abort transmission and return MixW to receive mode, but the last several characters typed will not be transmitted.

## **Olivia**

---

### **Introduction to Olivia Operations**

## **Olivia Operation**

---

### **Olivia.**

Olivia was designed and first implemented by Pawel Jalocho, SP9VRC. The draft specification for the Olivia HF transmission system can be seen at:

<http://www.qsl.net/a/aa3eu/olivia.htm>

### **Implementing Olivia in MixW.**

Effective with version 2.16 MixW has a capability for "External mode plugin support". This allows new

modes to be added to MixW without modification to the main MixW program. Olivia was the first mode implemented using this plugin support. In order to use Olivia in MixW 2.16 to MixW2.19 the file named ModeOlivia.dll must be downloaded from Nick's web site at <http://mixw.net> into the MixW program directory. For MixW2.2 and later ensure you have an internet connection select menu File|Extras|Modes. A list of available plugins will be displayed. Select all 3 and click on download. This will download all 3 additional mode DLLs into your data\plugins directory.

### Operating Olivia in MixW.

Olivia is a version of MFSK, and in MixW the operating procedures are the same as for MFSK with the exception of certain options which can be set in the Olivia | Mode Settings... dialog box. After installing the ModeOlivia.dll file restart MixW and select Mode | Olivia, then Mode | Mode Settings. You will see the following dialog box:

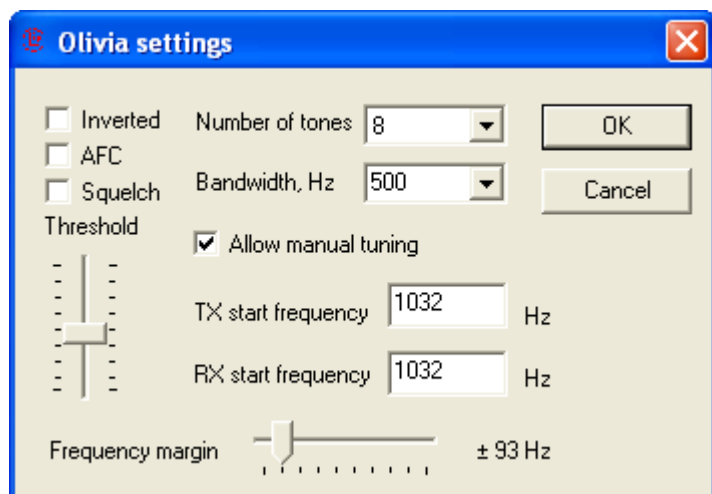

Be sure to check the "Allow manual tuning" box which will allow you to set the center frequency of the Olivia signal by clicking in the waterfall or spectrum.

The "Number of tones" can be selected from 8 different settings between 2 and 256, and the "Bandwidth, Hz" can be selected from 5 different settings between 125 to 200.

The tones/bandwidth combination are displayed in the status bar.



In practice, the normally used combinations are:

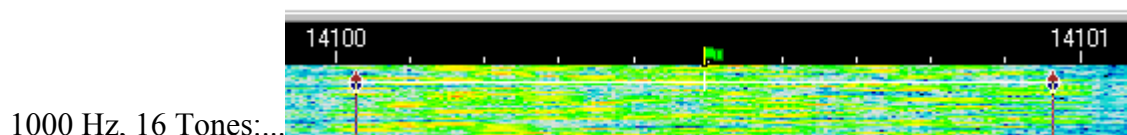
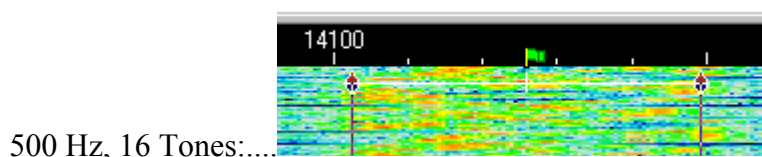
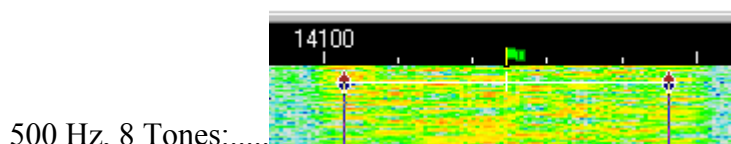

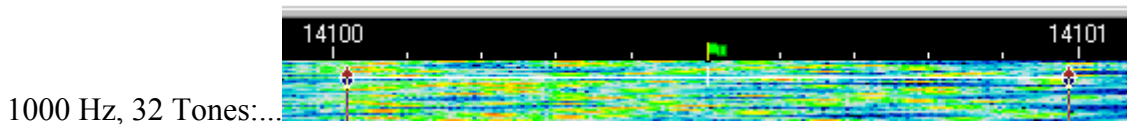

The signals seen on the waterfall are practically identical to Contestia and RTTYM signals. As with all digital modes, after a little experience the user will be able to identify the various formats visually in the waterfall.

It is important for successful Olivia operation that the soundcard is [calibrated](#).

### **Finding and Tuning Olivia Signals.**

Olivia under MixW is operated exactly like any other MFSK modes, by clicking the desired center frequency on the waterfall or spectrum display.

Frequencies currently being used for Olivia seem to be:

For 125/250/500 bandwidth just above the BPSK63/125 frequencies  
40 meters, 7072-7074  
30 meters, 10134-10139  
20 meters, 14100-14112

The best combination for calling CQ is probably 500 Hz, 8 Tones. However a common practice now is to call in whatever mode the operator wants to work in. Be careful using the 1000 Hz width, and particularly changing from 500 Hz, to 1000 Hz, that you do not cause interference to other users.

## **Contestia**

---

### **Introduction to Contestia Operations**

## **Contestia Operation**

---

### **Contestia.**

Contestia is a development from Olivia mode with reduced character set and robustness created by Nick Fedoseev (UT2UZ).

### **Implementing Contestia in MixW.**

Effective with version 2.16 MixW has a capability for "External mode plugin support". This allows new modes to be added to MixW without modification to the main MixW program. Contestia has been implemented using this plugin support. In order to use Contestia in MixW the file named ModeContestia.dll must be downloaded. To achieve this in MixW2.2 and later ensure you have an internet connection select menu File|Extras|Modes. A list of available plugins will be displayed. Select all 3 and click on download. This will download all 3 additional mode DLLs into your data/plugins directory.

## Operating Contestia in MixW.

Contestia is a version of MFSK, and in MixW the operating procedures are the same as for MFSK with the exception of certain options which can be set in the Contestia | Mode Settings... dialog box. After installing the ModeContestia.dll file and restarting MixW select Mode | Contestia, then Mode | Mode Settings. You will see the following dialog box:

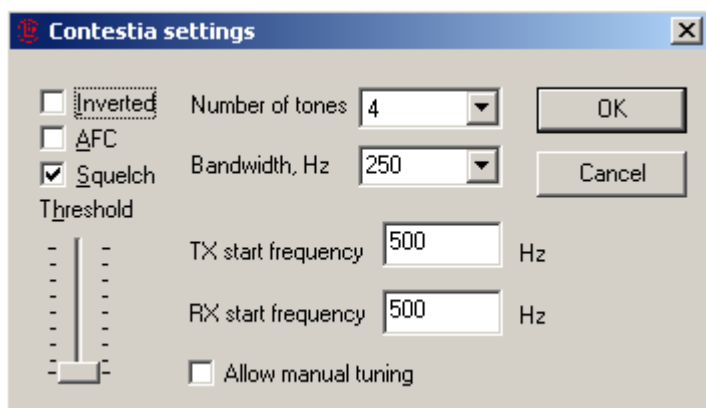

Be sure to check the "Allow manual tuning" box which will allow you to set the center frequency of the Contestia signal by clicking in the waterfall or spectrum.

The "Number of tones" can be selected from 8 different settings between 2 and 256, and the "Bandwidth, Hz" can be selected from 5 different settings between 125 to 200.

The tones/bandwidth combination are displayed as chars/s in the status bar.



The signals seen on the waterfall are practically identical to Olivia and RTTYM signals. As with all digital modes, after a little experience the user will be able to identify the various formats visually in the waterfall.

It is important for successful Contestia operation that the soundcard is [calibrated](#).

### Finding and Tuning Contestia Signals.

Contestia under MixW is operated exactly like any other MFSK modes, by clicking the desired center frequency on the waterfall or spectrum display.

Frequencies currently being used for Contestia seem to be:

- For 125/250/500 bandwidth just above the BPSK63/125 frequencies
- 40 meters, 7072-7074
- 30 meters, 10134-10139
- 20 meters, 14100-14112

The best combination for calling CQ is probably 500 Hz, 8 Tones. However a common practice now is to call in whatever mode the operator wants to work in. Be carefull using the 1000 Hz width, and particularly changing from 500 Hz, to 1000 Hz, that you do not cause interference to other users.

**Note:** QSOs with Mode Contestia will not be written to eQSL. Change the Mode in MixW's log to Contesti. This is the official [.ADI](#) file version 2 specification.

# RTTYM

---

## Introduction to RTTYM Operations

### RTTYM Operation

---

#### RTTYM.

RTTYM is a development from Contestia mode with further reduced facilities and robustness created by Nick Fedoseev (UT2UZ).

#### Implementing RTTYM in MixW.

Effective with version 2.16 MixW has a capability for "External mode plugin support". This allows new modes to be added to MixW without modification to the main MixW program. RTTYM has been implemented using this plugin support. In order to use RTTYM in MixW the file named ModeRTTYM.dll must be downloaded. To achieve this in MixW2.2 and later ensure you have an internet connection select menu File|Extras|Modes. A list of available plugins will be displayed. Select all 3 and click on download. This will download all 3 additional mode DLLs into your data\plugins directory.

#### Operating RTTYM in MixW.

RTTYM is a version of MFSK, and in MixW the operating procedures are the same as for MFSK with the exception of certain options which can be set in the RTTYM | Mode Settings... dialog box. After installing the ModeRTTYM.dll file restart MixW and select Mode | RTTYM, then Mode | Mode Settings. You will see the following dialog box:

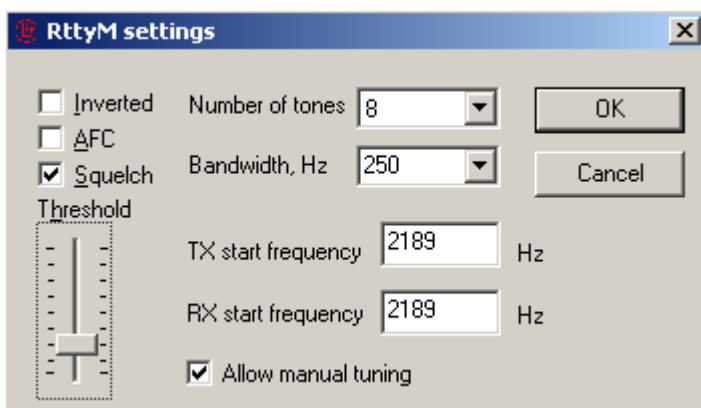

Be sure to check the "Allow manual tuning" box which will allow you to set the center frequency of the RTTYM signal by clicking in the waterfall or spectrum.

The "Number of tones" can be selected from 8 different settings between 2 and 256, and the "Bandwidth, Hz" can be selected from 5 different settings between 125 to 200.

The tones/bandwidth combination are displayed as chars/s in the status bar.

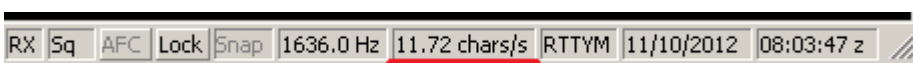

The signals seen on the waterfall are practically identical to Olivia and Contestia signals. As with all digital modes, after a little experience the user will be able to identify the various formats visually in the waterfall.

It is important for successful RTTYM operation that the soundcard is [calibrated](#).

### **Finding and Tuning RTTYM Signals.**

RTTYM under MixW is operated exactly like any other MFSK modes, by clicking the desired center frequency on the waterfall or spectrum display.

Frequencies currently being used for RTTYM seem to be:

For 125/250/500 bandwidth just above the BPSK63/125 frequencies

40 meters, 7072-7074

30 meters, 10134-10139

20 meters, 14100-14112

The best combination for calling CQ is probably 500 Hz, 8 Tones. However a common practice now is to call in whatever mode the operator wants to work in. Be careful using the 1000 Hz width, and particularly changing from 500 Hz, to 1000 Hz, that you do not cause interference to other users.

RTTYM is not as popular on the bands as Contestia and Olivia.

## **\*APPENDICES**

---

1. **Cat Bar/Cat config and Bands.ini**
2. **Contest Operation**
3. **DX Cluster**
4. **FAQ's**
5. **File Descriptions**
6. **HF Digital Modes Band Plan**
7. **Keyboard Shortcuts**
8. **Macro Commands**
9. **MixW External Resources**
10. **MixW Installation**
11. **MixW Release History**
12. **QSLPRINT.EXE**
13. **Script Commands**
14. **The Eye of a Needle (TEOAN)**
15. **TNC Configuration and Operation**
16. **Using MixW Voice Keying**
17. **Using MixW with DXAtlas**
18. **Using MixW with other programs, DDE**
19. **Using the Spectrum Display**
20. **Using the Waterfall--Step by Step**



# Cat Bar/Cat config

---

The Cat Bar, [Configure CAT/PTT](#) and [Bands.ini](#) file contents are used by MixW to control the way the Transceiver is set up by MixW.

## CAT Bar

The CAT Bar consists of three items, two drop down menus, one of which also displays as the transceiver frequency and tuning arrows.

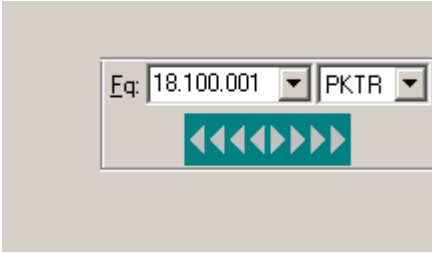

Position the mouse cursor over the left arrows and left click causes MixW to decrease the transceiver frequency. The further left the mouse is moved the faster the tune speed. Whilst the mouse cursor is over the left arrows right clicking will cause MixW to increase the transceiver frequency. The inverse is true for the mouse positioned over the right facing arrows.

The left drop down menu displays the current transceiver frequency and if the menu is selected all the bands configured in the bands.ini file are displayed. Bands can be added to or deleted from the bands.ini file.

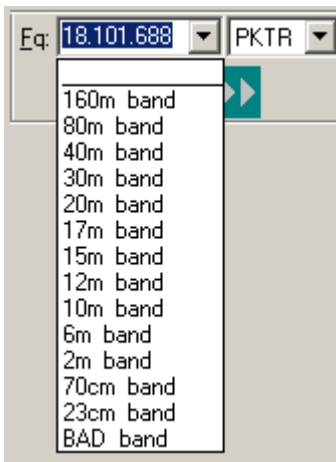

If a band is selected from this menu MixW will use the current MixW mode to read the preferred frequency and the transceiver mode from the bands.ini file and configure the transceiver accordingly. If the current mode does not have a separate entry for the band the ALL entry for the band will be used. If the transceiver mode is DEFAULT the mode selected will be as configured in menu Configuration|Trcvr CAT/PTT Default digi mode. If this entry is NONE no change will take place. If this entry is not valid for the transceiver results maybe unpredictable.

The right drop down menu displays the mode MixW believes the transceiver is in.

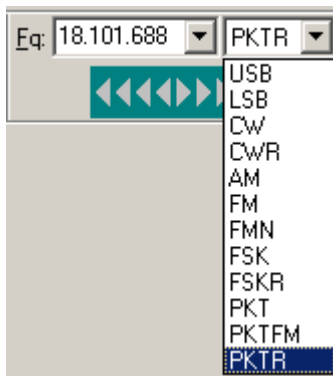

The transceiver type, as configured in Configure|TRCVR CAT/PTT menu, causes the selection of settings in this menu. The values in this menu are the ones to be used in the bands.ini file Tcvr mode position.

However the transceiver may not display the value shown in the window (the FTdx3000 shows Data USB but the menu item is PKTR).

## Contest Operation

---

MixW offers extensive support for contest operation, including special Macros, as well as special logging features. It can be configured for specific contests, and these settings can be stored for future use.

The full list of configured contests is shown in the List of Contests dialog from the View | Contest Mode. This brings up the List of Contests menu. You may edit, delete, or add new contest settings from this dialog. The "Select" button sets the active contest from the list of contests. Specific DLL files for many contests are also available from Nick's website. When downloaded and installed in the Plugins subdirectory, these DLLs will keep track of your statistics for that contest, as well as enable MixW to automatically calculate your scores for inclusion in your electronic log submission.

The contest mode is turned on or off from the View | Contest Mode menu. While In the contest mode, the Log Bar can be set to display exchange numbers instead of the name and QTH fields. To do this select View | Log bar | Contest layout.

The contest mode also allows you to check for previous QSOs made during the current contest only.

### **Configuring MixW's contest mode.**

For contest operation, first switch to the contest mode by selecting View | Contest Mode. This will bring up the following contest selection dialog:

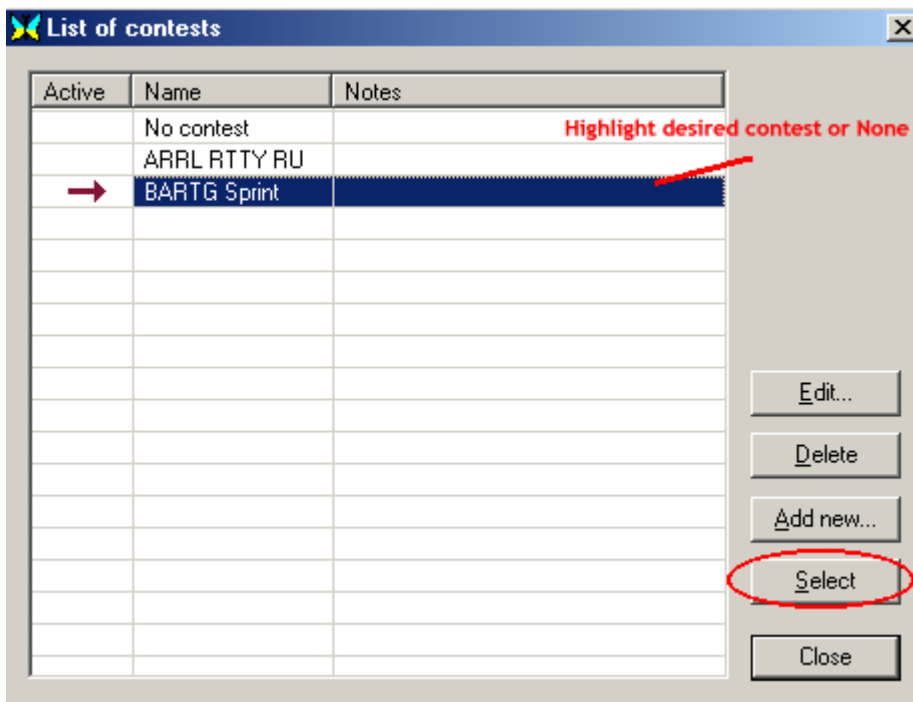

Select the active contest by highlighting it and pressing the Select button. From here you can also add a new contest, edit an existing contest, or change the active contest. (Selecting none returns MixW to the regular "non-contest" mode) To edit a contest, highlight it and select edit. To add a contest, click on the add button. Either of these options will bring up the following edit contest dialog box:

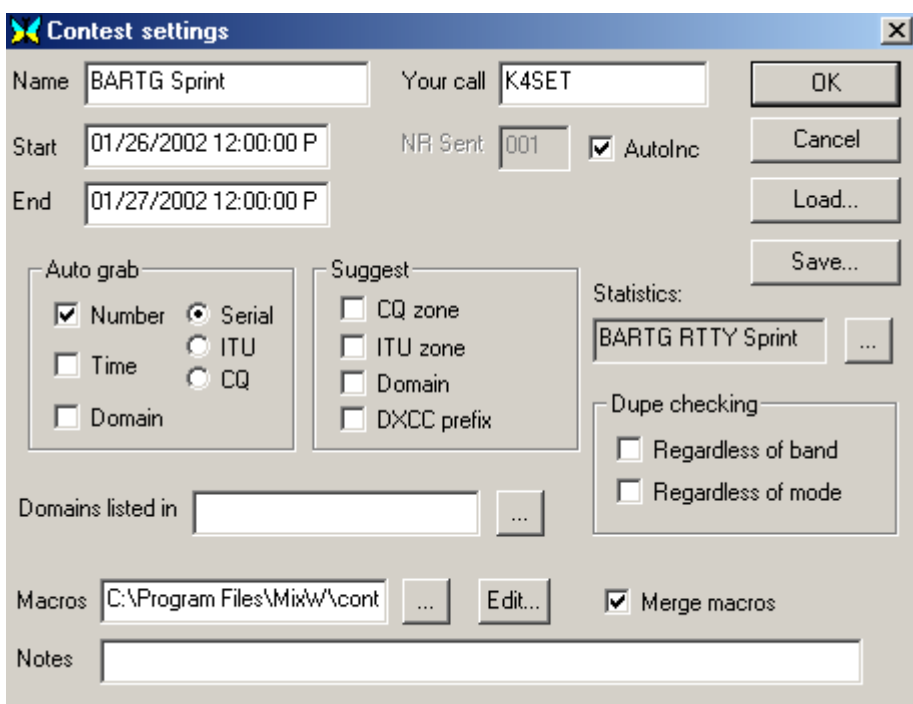

Here you can configure the logging features to suite the times and rules of the specific contest you are operating, and these settings can be saved and recalled for the next time you operate this contest (or a similar one).

**Name** - This is the name of contest, which appears at the top of MixW window when the contest mode is active.

**Your call** - specify the call sign you want to use in this contest. All QSOs during the contest will be logged with this call.

**NRS** is the report you send. If it is a serial number, enter the number you want MixW to start with, and

check the AutoInc box if you want MixW to automatically increment these numbers in your Macros and log.

**Note:** I found I had to check the AutoInc box, and then enter the first number manually in log bar to get this feature to work. If this specific contest requires a different type report, that can either be entered here, and simply leave AutoInc unchecked, or that can be added as text in your contest Macros.

**Start** is the start time of the contest.

**End** is the end time of the contest.

**Note:** Keeping track of the start and stop times enables MixW to know which QSOs count in the scoring and dupe checking.

If **AutoInc** is on, MixW automatically increments the number in the ExchSnt field of the previous QSO. If the previous QSOs has no number (such as at the very beginning of the contest) the number 001 is used.

If **AutoInc** is off, the **ExchSnt** field is just copied from the previous QSO. (The **NR sent** field from the Contest Settings dialog box is used at the beginning of the contest.)

The ExchSnt for the current QSO can be changed by typing another text in the pop up box that is displayed during the QSO.

**Auto Grab** - this feature allows auto-grabbing of serial numbers, time (such as for the BARTG contest) and states/counties/cantons/etc. from received data.

When the Auto Grab Serial number box is checked, MixW looks for strings that are likely to be a serial number and places them in the ExchRcv (exchange received) field of for the current QSO.

When the Auto Grab Time box is checked, MixW looks for time stamps like 2317 or 23:17 or 2317z or 23:17z, and places them in the Notes field. (This only works if the time does is not much different from the local computer's GMT time.)

When the other Auto Grab boxes are checked, MixW looks for a limited set of strings, which coincide with that type of data. Domains can also be checked and a .dom file (located in the Plugins directory) can be specified to determine where to place the data received. For instance:

A RUSSIAN.DOM file contains a list of Russian oblasts to grab automatically:

----- start of file -----

Ab = AB

Ad = AD

Al = AL

.....

(102 lines with oblast definitions)

----- end of file -----

Now both the received serial number and a grabbed domain are put to ExchRcv field of the log file.

DOM files use a simple data format compatible with N6TR software:

Each line consists of the left part, equal sign, and the right part. Lines without equal signs are ignored as comments.

The Left part is a domain name,

The Right part is a list of words to grab.

Samples:

Ab = AB

Cd = EF, GH

Ij = JKL, MNO, PQ, R

A DOM file can be specified for each contest with domains that you expect to encounter in that contest.

## Statistics

First you must download the specific contest DLLs available from the following sites:

Nick's Site: <http://www.mixw.net/>

Select the Contests page from the frame on the left of the home page. There are over 20 contests listed.

Jim Jaffe also maintains a collection of contest DLLs, which can be downloaded from:

<http://www.mixwusa.com/>

Victor, R3BB has a Mixw contest site where a number of up-to-date DLLs and links to contest rules can be found: <http://www.digitalrus.ru/>

Once downloaded these files should be unzipped into the Plugins directory, which is in the MixW folder. Next they are selected in the Contest dialog by clicking on the Statistics browse button:

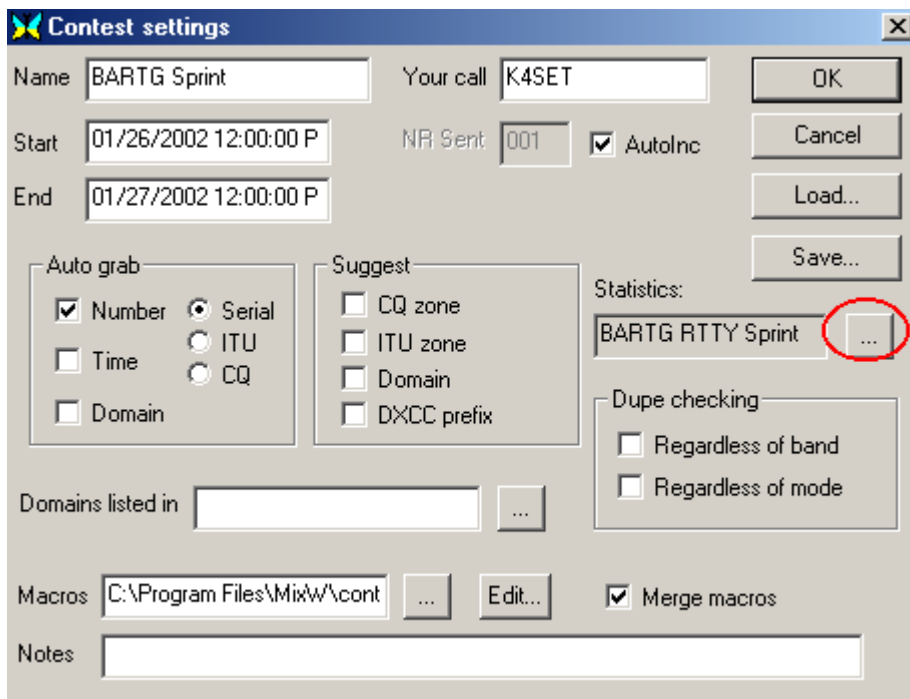

This brings up the following dialog:

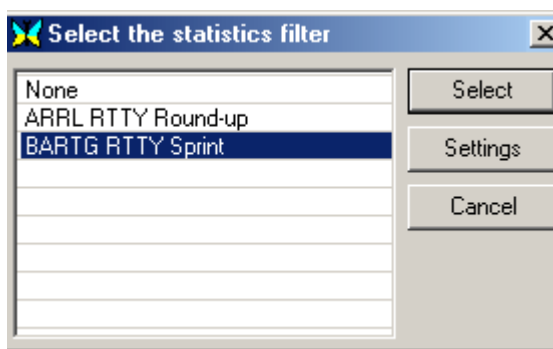

This is a list of available contest DLLs found in your Plugin directory. Simply highlight the desired contest DLL you wish to use for this contest and press the Select button. Some contests also offer settings options, which can be accessed from this menu as well.

With these DLLs installed and selected you can click View | Statistics - Show contest statistics, which will allow you to see your statistics as you work the contest in the following box:

	QSO	DX	JA	W
80m	3	1	0	3
40m	6	3	0	3
20m	17	7	0	6
15m	27	11	0	5
Total	53	17	0	9

Score:  $53 * (17 + 0 + 9 + 2 + 0) * 3 = 4452$  point

It's fun to watch your progress here as you work the contest. You can also view the Brief Log Statistics box for a more detailed view of your progress by selecting View | Statistics | Brief log statistics, which will display the following view of your progress:

Statistics for K4SET, contest: BARTG Sprint									
Callsigns:									
Band	Total	CW	SSB	DIGI	RTTY	PSK31	SSTV	WPX	
80m	3	0	0	3	3	0	0	3	
40m	6	0	0	6	6	0	0	6	
20m	17	0	0	17	17	0	0	17	
15m	27	0	0	27	27	0	0	24	
Total	49	0	0	49	49	0	0	42	
DXCC WKD/CFM:									
Band	Total	CW	SSB	DIGI	RTTY	PSK31	SSTV		
80m	1	0	0	1	1	0	0		
40m	3	0	0	3	3	0	0		
20m	7	0	0	7	7	0	0		
15m	11	0	0	11	11	0	0		
Total	17	0	0	17	17	0	0		

### Configuring the contest Macros

**Macros** - This is the name of a file containing the individual keyboard macros for this contest (or blank space if no individual macros are used).

**Merge Macros** - if this check box is unchecked, macros from the specified file will be directly assigned to the Control Bar keys. If it is checked, the macros from the file will be merged with the macros for the current mode and/or the default MixW macros.

**Notes** This can contain any useful information describing this contest.

There are several special keyboard macros, which can be used in the contest mode:

<NRS> - sent exchange number

<NRR> - received exchange number

<CLEARNRR> - clear the exchange received field

<INCNRR> - Increment the NRR field if it is an integer

<CTIME> - contest time (BARTG contest) like "2317" (hours and minutes)

<ONQSOBEFORE:macro> - if we had QSO before, run specified macro.

Here are some example contest Macros, which will prove very helpful while using the contest mode:

If a station calls you that you have worked before in this contest (a dupe), this macro tells him you have worked before, and then clears the QSO information from the log.

Macro: F9

Label: QSOB4

Text: QSO before!<CLEARQSO><RXANDCLEAR>

Now, when you press F9, the other station sees the message "QSO before", and then the new QSO data is erased.

<ONQSOBEFORE:macro> can also be used (for example, inside the macro that answers someone's CQ) to automate the process:

Without automation:

Macro: F5

Label: Answer

Text: <TX><CALL> de <MYCALL> 599 <NRS> <NRS> <RXANDCLEAR>

He sees " AB1CDE de UU9JDR 599 001 001 ".

With automation:

Macro: F5

Label: Answer

Text: <TX><CALL> de <MYCALL> <ONQSOBEFORE:F9> 599 <NRS> <NRS>  
<RXANDCLEAR>

In this case if you have not worked the station before they will see the above text. But if you have worked them before they will see " AB1CDE de UU9JDR QSO before! " and nothing more, because F9 macro with <RXANDCLEAR> at it's end and the "599 001 001" will not be sent.

You can configure Macros for a specific contest, but first you need to save the existing Macros to avoid loosing them and regretting it latter (ask me how I know about this!). Next, click on Save, and save the existing group as Basic. (You can skip this step if you have already saved the basic Macros). Now, let's load the generic contest Macros that come with MixW by selecting Configure | Edit Macros for this mode/group. This brings up the Edit Macro dialog box. Now you can load the default contest Macros that come with MixW by clicking on the Load button, then select the file "contest.mc". This will load the default Macros for contesting:

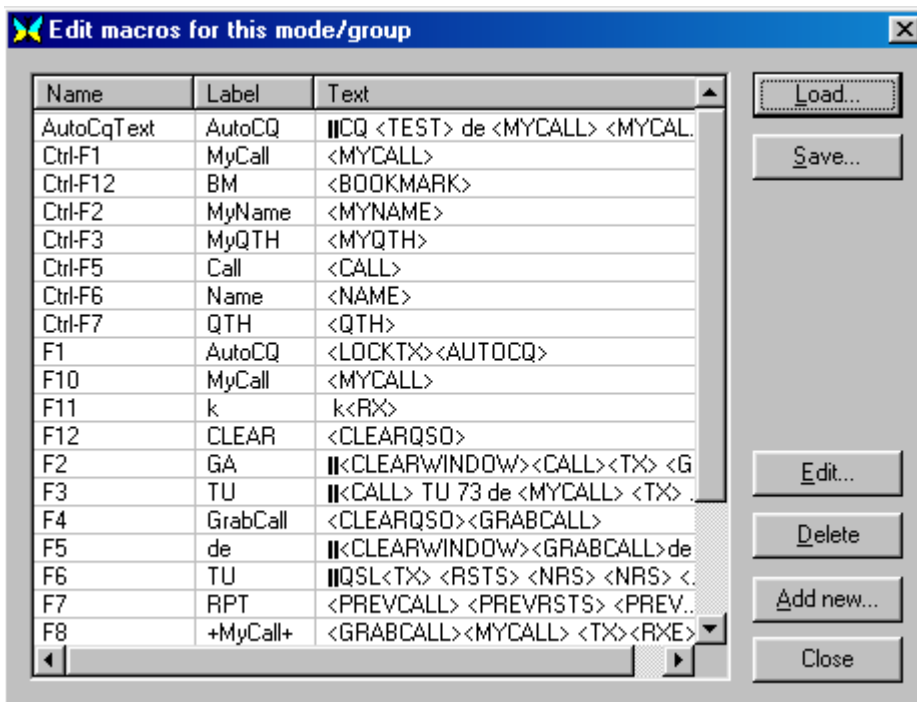

Now you can alter the Macros as you want them for this particular contest by double clicking on line (Macro) in this window, then edit them using the Edit Macro Window.

**As an example of contest specific Macros here is a suggested set of Macros for the CCCC contest.**

**Set one is for calling CQ in a contest:**

**CQ:** (To call CQ in the CCC contest)

<CLEAR><TX>CQ CQ CCC Test

CQ CQ Test de <MYCALL> <MYCALL> k<CR><LF><RX>

**AutoCQ:** (Assigns AutoCQ to the above Macro for this contest)

< ASAUTOCQ><CLEAR><TX>CQ CQ CCC Test

CQ CQ Test de <MYCALL> <MYCALL> k<CR><LF><RX>

**QRZ:** (To ask for another call when you haven't copied the station calling)

<CLEAR><TX>QRZ? AGN Pse de <MYCALL> k<CR><LF><RX>

**ANSWER:** (To answer a call with your report)

<TX><CALL> de <MYCALL> Hello, ur <RSTS>.<NRS>.<NRS> k<CR><LF><RX>

**REPEAT:** (To repeat your report)

<TX><CALL> Agn ur <RSTS>.<NRS>.<NRS> k<CR><LF><RX>

**CFM:** (Confirms and calls QRZ and saves the QSO to the log)

<TX><CALL> QSL 73 de <MYCALL> QRZ? k <CR><LF><SAVEQSO><RX>

**NOCFM:** (To ask for your report again)

<TX><CALL> PSE AGN UR REPORT de <MYCALL> k <CR><LF><RX>

**These two Macros are for answering in a contest:**

**CALL S/P:** (To call the station currently in <CALL>)

<TX><CALL> de <MYCALL> <MYCALL> k <CR><LF><RX>

**CFM S/P:** (To confirm, give your report, and save the QSO)

<TX><CALL> de <MYCALL> TNX, QSL, ur <RSTS>.<NRS>.<NRS> 73 de <MYCALL> k <CR><LF><SAVEQSO><RX>



**Note:** Ensure 'Use default RST' is ticked in the View menu to ensure an <RSTS> of 599 is always sent.

These can be altered to work in almost any contest. When your finished editing your Macros for this contest, consider saving these to a new Macro file so you can use them next time by clicking on Save, and then calling something related to this contest.

**The RUN, SEARCH AND POUNCE, and INTELLIGENT (<INT>) macros.**

There are several macros which are dependent on each other and the contents of certain fields in the contest log.

First, there are four macros to set the RUN or SEARCH AND POUNCE mode:

- <SP1> sets search and pounce mode on.
- <SP0> sets search and pounce mode off (run mode on).
- <SP> sets search and pounce mode off (run mode on).
- <S/P> toggles between search and pounce and run mode.

Second, there is the <INT> macro which is called by default by the OnCR macro when MixW is in the contest mode. The output of the <INT> macro depends on the content of the CALL and RX EXCHANGE fields as shown in the following tables:

**Search and Pounce Mode**

<u>Call</u>	<u>RX Exchange</u>	<u>.....Output.....</u>	<u>Macro to Edit</u>
-empty-	-empty-	?	INTQRL
NEWCALL	-empty-	de mycall	INTDE
WKDCALL	-empty-	nothing	none
NEWCALL	exchange	QSL UR 599 001 (saves QSL)	INTQSL

**Run Mode**

<u>Call</u>	<u>RX Exchange</u>	<u>.....Output.....</u>	<u>Macro to Edit</u>
-empty-	-empty-	CQ TEST DE mycall	INTCQ
NEWCALL	-empty-	newcall GA 599 001	INTGA
WKDCALL	-empty-	newcall QSO b4 QRZ	INTQB4
NEWCALL	exchange	QSL 73 QRZ de mycall (saves QSL)	INTQRZ

**Cabrillo file generation**

**Note:** The generated Cabrillo file (*yourcallsign.cbr*) is usually created in the default data directory.

Before generating a new Cabrillo file make sure you have saved the previous file if you need it.

Most contests today accept entries that are in the Cabrillo file format (see <http://www.arrl.org/cabrillo-format-tutorial> for information on the file specifications).

Before starting the Cabrillo file generation it is a good idea to have the contest rules available for display.

To create a Cabrillo file after a contest select the small spectacles button (Search) below left on the MixW log bar

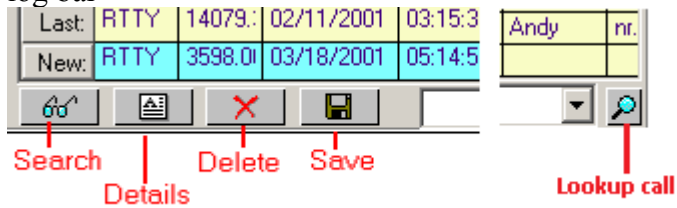

Uncheck all boxes except the Contest box in the Search in logfile selection window.

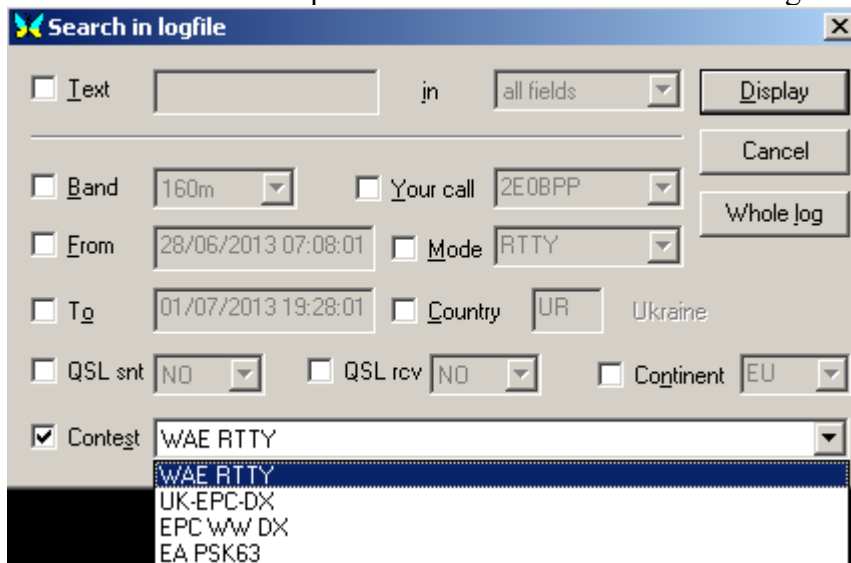

Select the contest name from the drop down list of contest names and click Display. The displayed log will have been selected by using the last contest settings date and time. If the start or end date and time are incorrect contest entries may be missed

Select the entries you wish to be entered in the contest and click on the to Cabrillo button at the bottom of the log display.

Search results - 35 QSO(s) found																
UTC start	UTC end	RX kHz	TX kHz	Mode	Call	Sent	R...	Na...	Q...	Dom	Cou...	IOTA	Loc	M...	Notes	NrS..
29/06/2013 10:24:48	29/06/2013 10:25...	21149...	21149...	RTTY	DJ2QXZ	599	599									001
29/06/2013 10:26:09	29/06/2013 10:26...	21149...	21149...	RTTY	EB5QQX	599	599									002
29/06/2013 10:26:37	29/06/2013 10:26...	21149...	21149...	RTTY	HA5ZZQ	599	599									003
29/06/2013 10:27:05	29/06/2013 10:27...	21149...	21149...	RTTY	EC7HQ	599	599									004
29/06/2013 10:27:28	29/06/2013 10:30...	21149...	21149...	RTTY	D4ZQ	599	599									005
29/06/2013 10:31:25	29/06/2013 10:31...	21149...	21149...	RTTY	RA2FQZ	599	599									006
29/06/2013 10:32:47	29/06/2013 10:32...	14080...	14080...	RTTY	EA1ZFX	599	599									007
29/06/2013 10:33:30	29/06/2013 10:35...	14080...	14080...	RTTY	UB0XEQ	599	599									008
29/06/2013 10:35:35	29/06/2013 10:35...	14080...	14080...	RTTY	G3XQZ	599	599									009
29/06/2013 10:36:03	29/06/2013 10:36...	14080...	14080...	RTTY	9A2QDZ	599	599									010
29/06/2013 10:36:44	29/06/2013 10:36...	14080...	14080...	RTTY	R6KQ	599	599									011
29/06/2013 10:37:04	29/06/2013 10:37...	14080...	14080...	RTTY	W2JZQ	599	599									012
29/06/2013 10:37:34	29/06/2013 10:37...	14080...	14080...	RTTY	HP4EQD	599	599									013
29/06/2013 10:40:01	29/06/2013 10:40...	14080...	14080...	RTTY	7U2XY	599	599									014
29/06/2013 10:40:25	29/06/2013 10:42...	14080...	14080...	RTTY	VE3QAX	599	599									015
29/06/2013 10:42:39	29/06/2013 10:42...	14080...	14080...	RTTY	VK4DQY	599	599									016
29/06/2013 10:42:58	29/06/2013 10:43...	14080...	14080...	RTTY	LA2WQH	599	599									017
29/06/2013 10:43:22	29/06/2013 10:43...	14080...	14080...	RTTY	SA6FZY	599	599									018
29/06/2013 10:43:48	29/06/2013 10:43...	14080...	14080...	RTTY	Dw1K	599	599									019
29/06/2013 10:44:15	29/06/2013 10:44...	14080...	14080...	RTTY	E77ZAQ	599	599									020
29/06/2013 10:44:55	29/06/2013 10:45...	14080...	14080...	RTTY	LU2QV	599	599									021
29/06/2013 10:47:17	29/06/2013 10:47...	14080...	14080...	RTTY	VK8WQG	599	599									022
29/06/2013 10:50:06	29/06/2013 10:50...	14080...	14080...	RTTY	OX4RE	599	599									023
29/06/2013 10:51:05	29/06/2013 10:51...	14080...	14080...	RTTY	JW3QAQ	599	599									024
29/06/2013 10:52:25	29/06/2013 10:54...	14080...	14080...	RTTY	IH9ZED	599	599									025
29/06/2013 11:00:45	29/06/2013 11:00...	14080...	14080...	RTTY	D5QG	599	599									026
30/06/2013 04:33:02	30/06/2013 04:33...	14080...	14080...	RTTY	RZ6LJQ	599	599									027
30/06/2013 04:41:35	30/06/2013 04:41...	14080...	14080...	RTTY	HI8YQ	599	599									028
30/06/2013 04:43:06	30/06/2013 04:43...	14080...	14080...	RTTY	ON3YZ	599	599									029
30/06/2013 05:42:19	30/06/2013 05:42...	14080...	14080...	RTTY	ZL2WSZ	599	599									030
30/06/2013 05:54:59	30/06/2013 05:54...	14080...	14080...	RTTY	EA8YPQ	599	599									031
30/06/2013 05:56:55	30/06/2013 05:56...	14080...	14080...	RTTY	CN2JZQ	599	599									032
30/06/2013 06:02:38	30/06/2013 06:03...	14080...	14080...	RTTY	4Z1QA	599	599									033

- Select all
- Select QSOs with contest numbers
- QSOs with numerical contest numbers
- Invert selection
- Set QSL Sent Ctrl-Shift-S
- Set QSL Received Ctrl-Shift-R
- Set QSL Sent+Received Ctrl-Shift-Q
- Print QSL Ctrl-Shift-P
- Send QSL(s) to eQSL.cc Ctrl-Shift-L
- Set eQSL Sent Ctrl-Alt-Shift-S
- Set eQSL Received Ctrl-Alt-Shift-R
- Search call UB0XEQ

The steps following the selection of to Cabrillo depend on the contest and maybe controlled by either the conteststats.dll or MixW. You may have a further selection to make or you could have to fill in the information for the Cabrillo header file. For this you may need the contest rules to sort out the correct information.

Finally you will OK the information and a message box will be displayed informing you a file *yourcall.cbr* has been created. This file is in the MixW data directory (or just the MixW directory for MixW2.19 and earlier versions).

Check your Cabrillo file using your favourite text editor **BEFORE** submitting it.

Some Stats dlls create an ini file in the Plugins folder, some do not. **QTCs**  
 With thanks to Pat ON2AD for the original information.

QTC means how many messages do you have for me or I have xx messages for you in the Q-Codes.

In contests QTCs are a good source of points, particularly the WAE ([Worked All Europe](#)) RTTY contest. The rules provide information on QTCs and how to use them.

A QTC consists of up to 10 entries which contain information, taken from the log, of each contest QSO completed.

Each entry comprises:

Time of QSO *sep* Callsign *sep* Exchange received

where *sep* is a separator character, dependent on which software was used to create the QTC

e.g.  
 0836/CA1ZZZ/042

**MixW and the WAE contest**

To set up MixW for the WAE contest:

Download the statistics file StatsWAE.zip from Victor Kosobokov (R3BB)'s contest web site <http://www.digitalrus.ru/>

Extract the two files. Copy StatsWAE.dll into the MixW data folder Plugins subfolder. Copy darc-wae-rtty.mc file into the MixW data folder. This file contains a set of macros suitable for use with the contest. Use the contest set up to create a WAE contest entry in the contest list

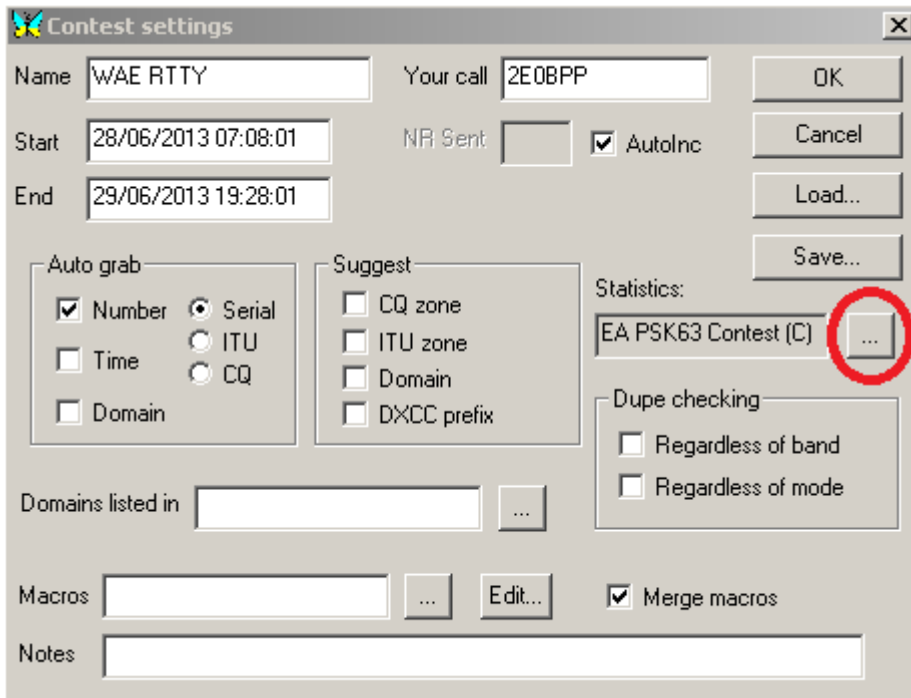

Click on the button to the right of the text box below the Statistics: heading. This will bring up the Select the statistics filter selection box.

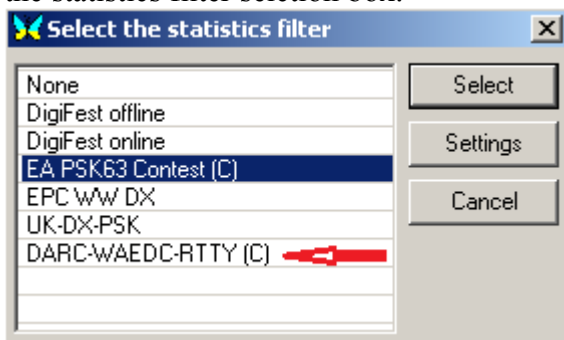

Select the DARC-WAEDC-RTTY (C) entry then click on Settings.

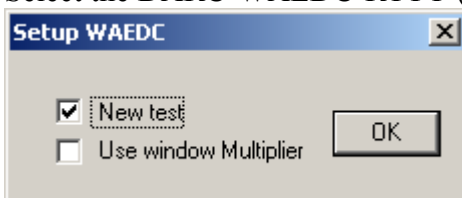

Select New test if this is the start of the test. This will clear any files left over from the last time the test was entered. Select Use window multiplier to display all countries worked on the band currently selected. Use the OK buttons to save the data.

If QTCs are to be exchanged five macros are required:

<STATS:ReadQTC>

Initiate the reception of QTCs

<STATS:SendQTC>	Initiate the transmission of QTCs
<TX>I have QTCs to send<RX>	Inform remote operator of QTC availability.
<TX>Have you QTCs to send?<RX>	Inform remote operator you can receive their QTCs.
<TX>SRI no QTC! 73<RX>	Inform remote operator no QTC operations.

These macros are included in the macro file extracted from the zip file above.

### Transfer of QTCs

For MixW2.19 and earlier first save the QSO. If there is no valid current QSO a request is made for the callsign of the station the QTC exchange will be with.

If an exchange is requested with a station in the same continent as your station a message box is displayed stating the exchange is not permitted (see the contest rules).

### Sending QTCs

Execute the macro <STATS:SendQTC>

This displays the Send QTC window

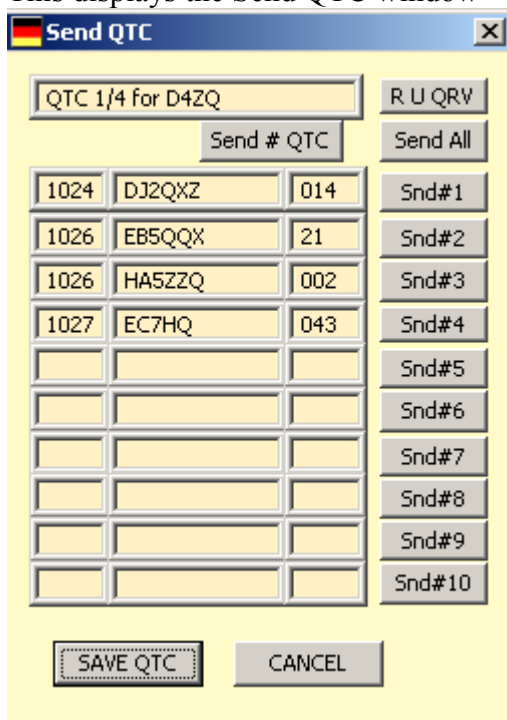

The Buttons have the following actions:

R U QRV      Ask the recipient if they are ready to receive the QTCs

Send # QTC      Send the QTC header information

Send All      Send all the QTC data

- Snd#n            Send single QTC #n
- SAVE QTC        Save the QTCs sent to the QTCTX.log. Send a 73 message
- CANCEL            Cancel the QTC exchange. No data is written to the QTCTX.log

**Receiving QTCs**

Execute the macro <STATS:ReadQTC>

This will bring up the Receive QTC window

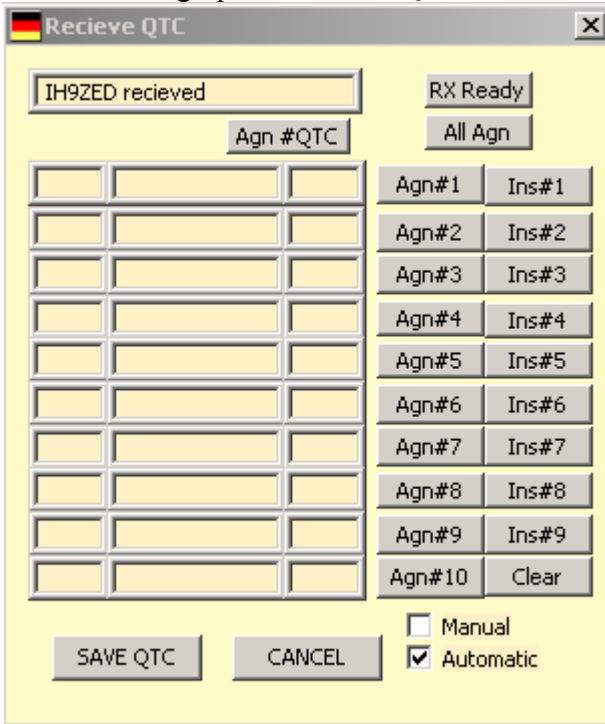

The Buttons have the following actions:

- RX Ready    Send message informing sender you are ready to receive the QTCs
- Agn #QTC    Request repeat of the QTC header information
- All Agn      Request repeat of all the QTC data
- Agn#n        Request repeat of a single QTC #n
- Ins#n        Create a blank entry on line #n. It will then be necessary to request QTC #n again
- SAVE QTC    Save the QTCs received to the QTCRX.log. Send a message confirming reception of the QTCs
- CANCEL        Cancel the QTC exchange. No data is written to the QTCRX.log

Check boxes Manual and Automatic select whether the data will be filled in by StatWAE.dll (Automatic) or if the data will be selected and copied across by the operator.

In manual selection when QTCs are received correctly highlight the whole message and click on Add to statistics on the drop down menu

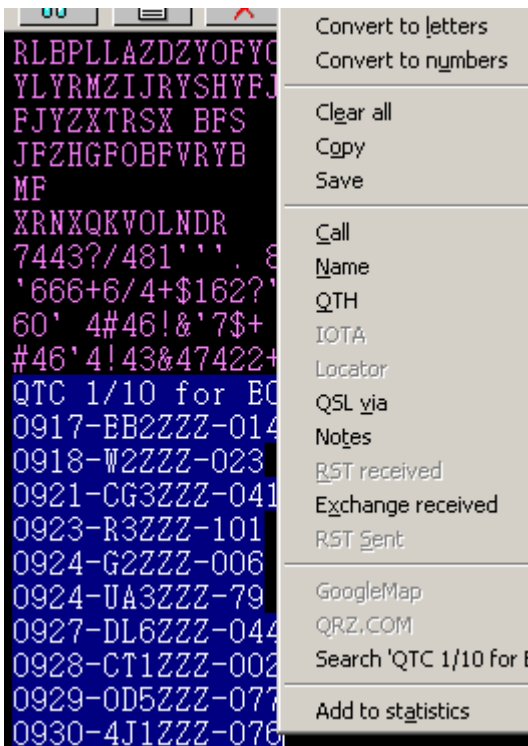

and the data will be added to the Receive QTC window.

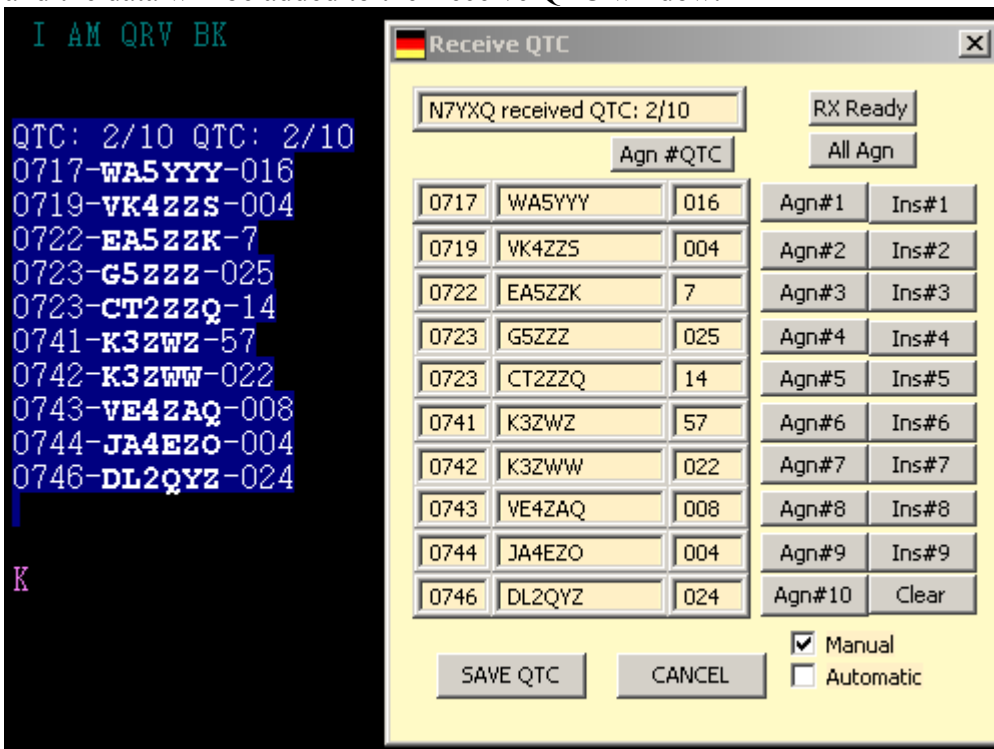

Note:

As well as the individual QTCTX.log and QTCRX.log files a third file QTC.log is also maintained.

Before creation of the Cabrillo contest log entry file these files can be edited to correct the information if required.

### Entry log file generation

The StatsWAE.dll is capable of generating either an STF or Cabrillo file format.

The entries to be included in the test are [selected in the usual way](#) and when the Cabrillo button is selected a Windows selection box is displayed for either Cabrillo or STF format. Whichever is selected the appropriate file is created and stored in the MixW data folder (there is no option to save it elsewhere)

overwriting the previous file (which may have been for a different contest).

**Note:**

There is another file StatsWAE.dll available. This file was created by the MixW team in 2003. This file can also send and receive QTCs but does not have the capability to create contest entry files (Cabrillo or STF format)..

**Use the StatsWAE.dll created by Victor (R3BB).**

## DX Cluster

---

MixW has a built in DX Cluster window, which can obtain data from either a Packet, Telnet or Internet DX Cluster. To activate this window select View | DXCluster dialog. This brings up the following window:

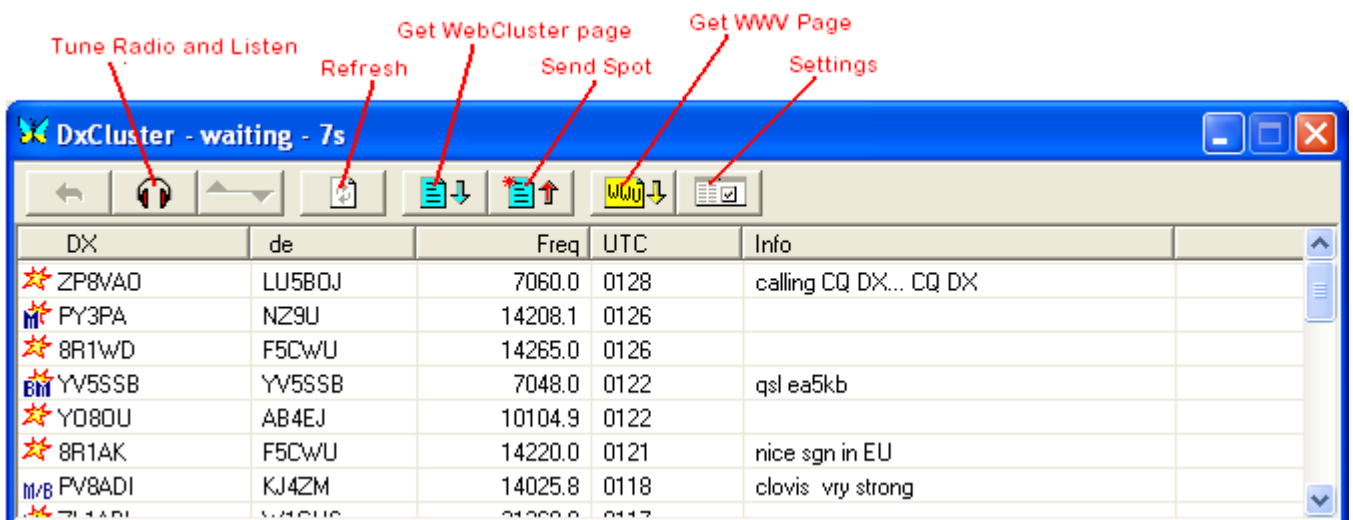

**Internet based "WebCluster":** Clicking on the "Settings" icon allows you to set the options for the DXCluster window. The options shown below are the default settings, which are for the DX Summit WebCluster. Another WebCluster can be substituted by filling in the appropriate server, port, and page information.

**DO NOT put a Telnet DXCluster URL in the WebCluster Server drop down list box.**



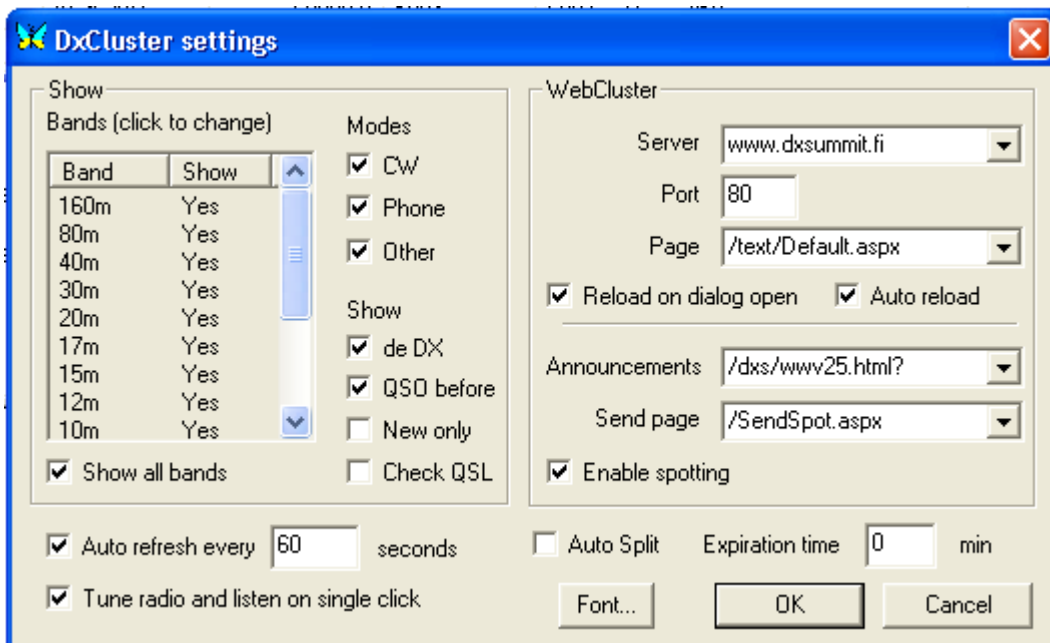

**Packet based DXCluster:** For the Packet DXCluster to work you must have a packet TNC connected and configured. This is done by selecting Configure | TNC settings. You can also write a script file to connect your TNC to the packet DXCluster. Then configure the Settings as shown for the Telnet based DXCluster below.

**Telnet based DXcluster:** You can use a Telnet DX cluster by telneting to the cluster and signing on manually using View | Telnet Window and clicking Connect. You can then use the Telnet Cluster in the Telnet window, or configure the MixW DX Cluster window. Using the MixW DX Cluster window will give you the advantages of a formatted display, and the ability to click on a spot and automatically QSY the radio (using CAT) to the location and mode of the DX. To configure the MixW DX Cluster window for a Telnet or Packet DXCluster, click on the Settings button and DELETE the entry in the server drop down box as shown below.

**Do NOT put the URL for a Telnet DX Cluster in the server box.**

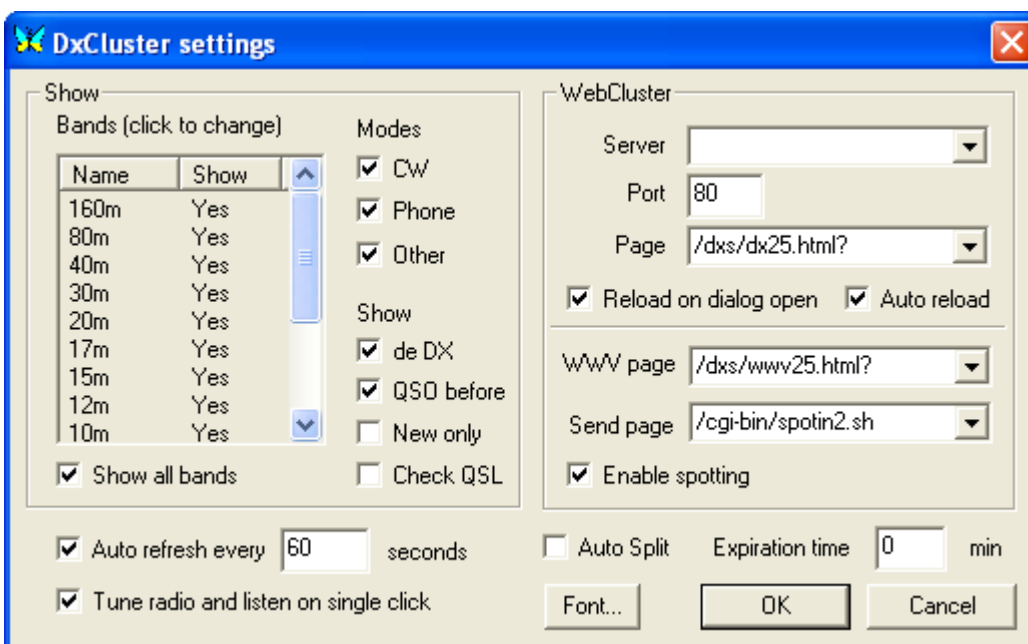

Click the OK button to close the Settings window and the MixW DX Cluster window will show "grey" buttons for the Get Web Cluster Page, Send Spot, and Get WWV Page buttons. The two windows below show the DX Cluster window and the Telnet windows displaying the same spots. You can then minimize either or both of the windows.

**DxCluster - waiting - 19s**

DX	de	Freq	UTC	Info
★ 7Z1UG	4Z5ML	14022.0	0158	CQ CQ CQ
★ 4X4PP	W8YRB	10108.0	0159	

**k1ttt.net:23 - Telnet**

```

Connect Disconnect Run script Run last Echo AutoLf Logging
TIP: SH/DX Stats - Shows node DX statistics
New Mail: Personal = 0 Bulletin = 1
67 nodes, 50 local / 289 total users Uptime 25 03:18
K6IX de K1TTT 13-May 0159Z arc >
13-May-2006 0159Z Logging out user on node K1TTT: K5RAT-2
13-May-2006 0159Z Logging in user on node K1TTT: K5RAT-2
DX de W8YRB: 10108.0 4X4PP 0159Z
DX de 4Z5ML: 14022.0 7Z1UG CQ CQ CQ 0158Z
13-May-2006 0201Z Logging in user on node K1TTT: AD4EB

```

## DX Cluster Selection Transceiver Setup

**Note:** This information was found by trial and error and may not be completely accurate.

Remember the frequency being spotted may be well outside the recommended bands.ini setting or your personal bands.ini setting.

Following a click on an entry in the MixW DxCluster window an attempt is made, using CAT control, to set the transceiver to the correct frequency and mode. This is not always successful as a number of pieces of information from sources other than the DxCluster window are used. The frequency should be correct but the mode selected may not be.

The information that may be used is:

- Information in the DX Cluster Info entry
- [Bands.ini file](#)
- Default [CAT Configuration](#) Setting

If the DX Cluster Entry has a recognisable mode in the Info column then this mode is used. Next MixW will use the frequency to look up a mode in the bands.ini file. If the entry in the bands.ini file is unambiguous then the mode will most probably be correct. However if there are multiple entries for a particular frequency results will be unpredictable. MixW looks at the Preferred frequency column and will use the closest value in this (right hand) column to select the mode. Finally MixW will use the Default Digital Mode as defined in the CAT/PTT configuration menu item.

This is the default entries for the MixW3.1.1h delivered bands.ini file for the 20 metre (14mhz) band.

; 20m band

20m SSB USB 14100 14350 14100 ; Defines the upper band limit

20m CW CW 14000 14350 14010 ;Defines the lower and upper band limits

20m RTTY DEFAULT 14065 14112 14080

20m BPSK31 DEFAULT 14065 14112 14070

20m QPSK31 DEFAULT 14065 14112 14070  
20m FSK31 DEFAULT 14065 14112 14070  
20m PACKET DEFAULT 14065 14112 14105  
20m HELL DEFAULT 14065 14112 14062  
20m SSTV USB 14220 14240 14230  
20m ALL DEFAULT 14065 14112 14070

For the frequencies 14000 to 14065 and 14112 to 14220 there is no problem. Any entry with a frequency in these ranges will be set to the bands.ini setting provided no mode is set in the Info column. However an entry for a frequency of 14238 will be set to SSTV.

A frequency of 14072 will be mode BPSK31 as this is the first mode found with the closest preferred frequency to the entry frequency.

Try setting your bands.ini file from the [Bands.ini file](#) section of these help files.

## FAQ

---

### **I have changed my call or lost my registration file.**

Send an email to the person you got your original registration file from giving them your old and new call signs.

### **My Menus do not look like the Menus in MixWHelp.**

MixW has two Menu Layouts.  
Go to View | Menu and choose Layout 1.

### **I cannot find Olivia, Contestia or RTTYM in my Modes Menu.**

These are "plug in modes". For MixW 2.19 and earlier there must be a dll file for each mode in your MixW program folder.  
If it is not there go to <http://www.mixw.net/> and download it.  
For MixW2.2 and later the dll files must be installed in the User Data folder Plugins folder.  
To download the dll files:  
ensure you have an internet connection  
Start MixW and ensure you have menu 1 layout  
Select File->Extras->Mode... Click on Select All and then Download  
All 3 mode dlls will now be downloaded to the correct location to be accessible to this MixW installation.

### **MixW will not transmit.**

Your callsign must be entered under Configure | Personal Data.  
TX/RX switching via VOX, RTS/DTR, or CAT must be properly configured.  
"DSP Filters" must be set to "none" under Configure | Soundcard Settings.

### **I can not get out of "Lock" mode.**

In CW: Go to Configure | TRCVR CAT/PTT and click "CW out via soundcard".

In RTTY: Go to Configure | TRCVR CAT/PTT and click "AFSK in place of FSK".

SSTV does not allow tuning on the waterfall. You must use the Tcvr tuning control to adjust the signal.

For Olivia, Contestia and RTTYM the lock can be over-ridden by:

Select Menu Modes->Mode settings and tick the Allow Manual Tuning box.

Manual tuning is only suitable for more powerful or multi-core CPUs.

### **I have totally goofed up my screen layout.**

In your MixW installation folder, rename the MixW2.ini file to OldMixW2.ini.

Restart MixW and your screen configuration will be set back to the original format.

When you get you screen layout set the way you like it, be sure to backup the MixW2.ini file.

### **Changes to my screen layout are lost when I quit MixW.**

In your MixW data folder, right click on the MixW2.ini file then left click on Properties at the bottom of the pop up menu. At the bottom of the MixW2.ini Properties dialog are two attributes, Read Only and Hidden.

Read-only must NOT have a checkmark in the attribute box. Click OK to close the dialog box.

Now when you make screen layout changes in MixW the changes will be saved to the MixW2.ini file.

### **If I shut down MixW during a contest and start up later to continue with the contest I lose my sequence numbers and DUPE function.**

When you restart MixW during a contest you must ensure the contest beginning date and time are set to the original contest start time. MixW automatically saves the contest settings in the file MixContests.ini.

### **I don't understand how to calibrate my sound card.**

See [Sound Card Calibration](#) in the Basic Set Up section of Configuration and Set Up.

### **For very slow computers:**

Turn the tuning indicator off by selecting View | Tuning indicator (should be unchecked).

Set the spectrum speed to Slow (under Configure | Soundcard settings).

Set samplerate to 8000 (under Configure | Soundcard settings).

Set DSP filter to none (under Configure | Soundcard settings).

Reduce the height of waterfall. (Use the cursor)

Turn off the average spectrum line (if not in the waterfall mode) (View | Spectrum | Average curve)

| None.

### **Waterfall seems to move very slowly.**

Set the Spectrum speed (Configure | Soundcard settings) to a higher value (x4 is OK).

### **CAT interface doesn't work.**

Refer to the interface manual and set the RTS and DTR state properly (Configure | TRCVR CAT/PTT, and click on the Details button).

Several interfaces require RTS=Always On and/or DTR=Always On. With these transceivers, the Hardware Flow Control does not work and should be unchecked.

Make sure the MixW Com port settings match the settings in the transceiver. In particular the Baud Rate. Some transceivers have a preset baud rate and they may not match the value assigned as a default by MixW.

### **It's very difficult to tune to MFSK16 signals.**

Right-click at waterfall window and set Zoom to x2 or x3.

### **Name and QTH of non-US stations are not automatically filled from Radio Amateur Callbook (RAC) CD-ROM.**

P.O. Box 2013, Lakewood, NJ 08701, USA - drop them a letter asking why they didn't make the non-USA records properly!

But for now, In MixW you can use the drag-and-drop method to copy the name and QTH from the Callbook window.

### **Is there <RESYNC> macro for MT63?**

Two possible solutions:

Position the mouse cursor over the centre of the MT63 signal. Then hold the keyboard shift key down and left click with the mouse.

Try to use <REPLAY> or <REPLAY:seconds>. It will resynchronize the receiver and also replay the sound history not to lose any information.

### **Is it possible to export selected QSOs?**

See [Printing and Exporting your log file](#) in the Logging and QSLing section of Operation.

### **I cannot find an ADIF file I have just created.**

If you have created the file using the *Search Log->to ADIF* function and used the default setting in the "Input file name for ADIF export" text box selection carry out the following steps:

Create a macro <EXT:start cd> and execute it.

This will bring up a CMD window the last line of which shows the absolute path name to the directory containing your ADIF file.

Ignore the > character at the end of the line.

This is the path of your MixW data directory.

### **Is it possible to work PSK having another mode at second receiving channel?**

Yes, right-click a second RX channel window, click Mode... and choose a new mode for this window.

### **When I edit my macros, using the Edit Macro box, I find using copy and paste puts the data in the wrong place.**

When using highlight and copy (to clipboard) you must highlight from right to left. Then if you want to highlight and overwrite text in the macro this must also be highlighted from right to left. This problem also occurs in the same way when editing text in the Transmit window.

### **The frequency display above the Waterfall has changed to AF but the CAT bar is correctly tracking my trcvr frequency.**

The most likely problem is the menu View|Spectrum has the Sound setting checked. Select Auto for MixW to decide which sideband you are using or check the appropriate setting for your mode of operation, either Upper or Lower sideband.

### **Why doesn't the log frequency date or time update? It worked yesterday.**

The most likely reason is you have gone into manual logging mode. Select View|Log and uncheck Manual entry mode.

### **Where do I find an uncorrupted version of MixW? When I try to download MixW I get a file corrupted message.**

You must download MixW on to your hard disc and then run it from there. Do not try to run it from the download instructions.

### **How do I get MixW3.1.1h to run on my Windows98Se machine?**

Unfortunately you can't. MixW3 requires Version 5 of Shell32.dll. Microsoft states Shell32.dll version 5 will only run on Windows 2000 systems and later.

By implication this means MixW3 cannot run on any system earlier than Windows 2000.

For additional help and discussion on using MixW please subscribe to the MixW email reflector by following this link:

<http://groups.yahoo.com/group/mixw/>

## **File Descriptions**

---

### **.adi (ADIF) file description and creation**

### **Bands.ini file description**

### **Cty.dat File description**

### **MixW initialisation file**

### **MixW log file**

### **Master.dat file description**

### **Pfx.dat file description**

## **ADIF Files**

---

Files with a suffix .adi should be files created using the Amateur Data Interchange Format.

See [The independent ADIF site](#) for up to date information.

MixW2.19 and earlier write the ADIF spec version 1 format but from MixW2.2 the version 2 format is used. MixW writes a 5 line header file that indicates it is using ADIF version 1 format what ever version of MixW is used to create the .adi file.

Because MixW2.19 and earlier uses ADIF V1 this limits the modes that can be written. It would appear the MixW team and eQSL team did attempt to allow modes not specifically in the ADIF V1 spec to be written to eQSL but this was lost when eQSL updated to V2 spec (and MixW did not). So MixW will not log any QPSK QSOs up to MixW2.19.

The only known problem of logging data to eQSL at MixW3.1.1 is mode Contestia in MixW should be Contesti in the .adi file. eQSL will reject the record if mode Contestia is input to it.

.ADI file creation in MixW.

Select the QSOs to be included in the file by using the Search log facility.

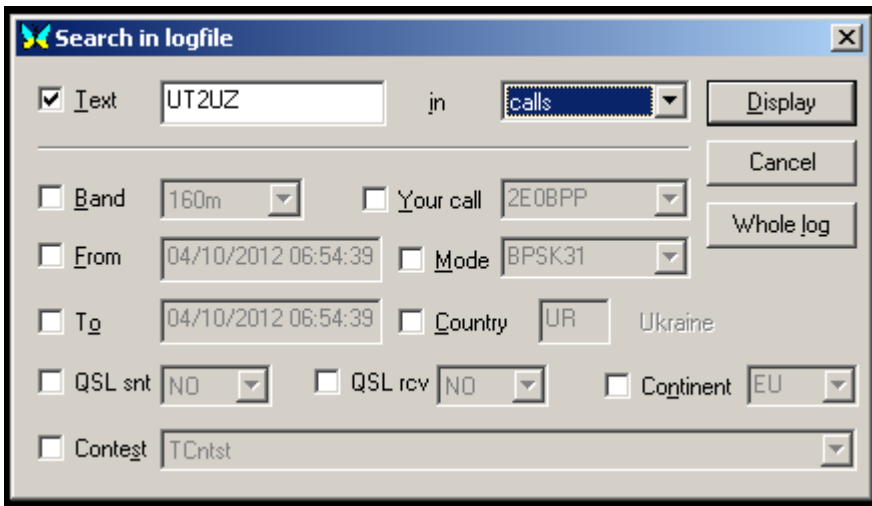

Either click on Whole log to display the whole log or fill in the search criteria and click on Display

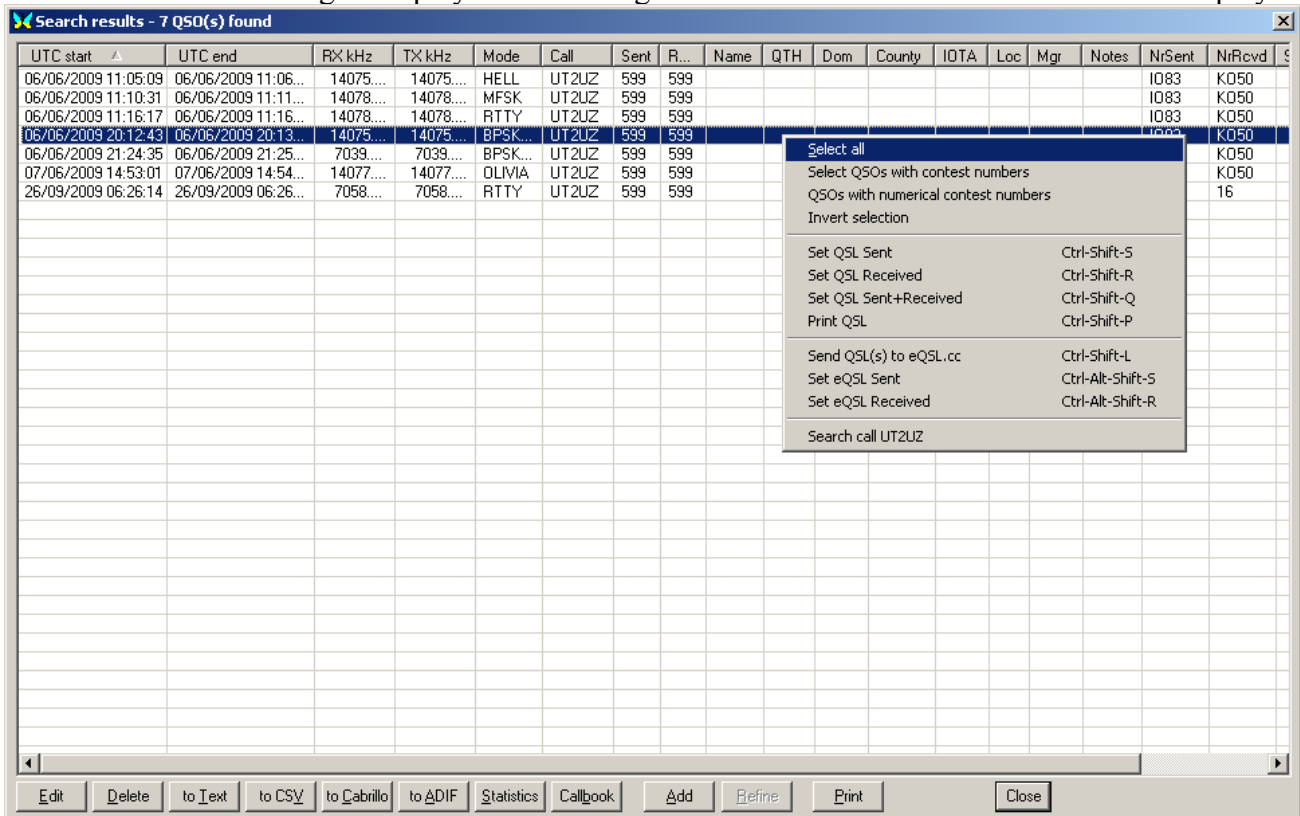

To to select all QSOs displayed position the cursor over any entry, click the right mouse button to bring up a further action window and select all.

If all the displayed QSOs are not required. To make a further selection from the displayed QSOs the standard windows selection actions can be used by use of the left mouse button and the Ctrl and Shift keys to select the QSOs.

When the selection is made left click on the to ADIF button. This will bring up a file selection box:

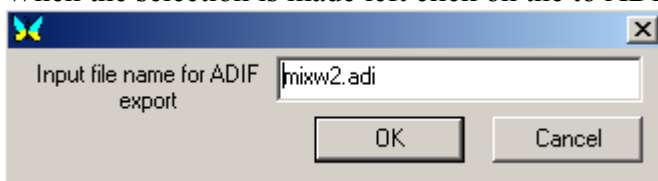

If no changes are made the default file MixW2.adi will be saved in the default data directory and will overwrite any previous file in this directory with the same name.

The file name and destination maybe changed.



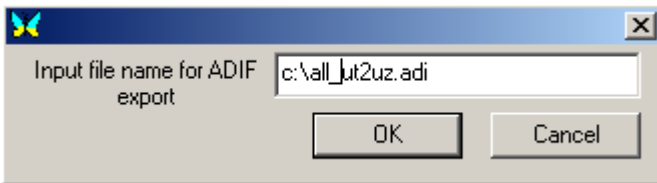

In the example above file all\_ut2uz.adi will be saved in the root directory of the C: drive.

The newly created file can be modified by using a text editor (e.g. Change the mode Contestia to Contesti) but make sure the ADIF file format specification is adhered to.

## Bands.ini File

---

**Note:** this file should be checked after installation to ensure the correct limits are applied to the bands.

The bands.ini file defines the limits of the ham bands MixW will operate in and allows configuration of personal choice in frequency and mode selection.

Each line consists of 6 space/tab separated data columns plus an optional comment column. The lines for each band are grouped together for readability but do not have to be in any particular order. A line beginning with a semi-colon is considered a comment line and is ignored.

The entries are:

Band	MixW Mode	Tcvr Mode	Start fq khz	End fq khz	Prefered fq khz	Comment
Numeric data in metres or centimetres with m or cm appended to the figure	A mode that can be selected from the Modes menu. Can also be ALL which defines the action for all other modes not in this band.	A mode that appears in the Cat Bar drop down menu. Varies between manufacturer and transceiver models. Can also be DEFAULT which is the Default Digimode set in the Configure TRCVR CAT/PTT set up menu.	The lower frequency within the bandplan for this MixW Mode within the band.  <i>The lowest frequency in this column defines the lower band limit</i>	The upper frequency in the bandplan for this MixW mode.  <i>The highest frequency in this column defines the upper band limit</i>	The preferred frequency MixW will set when switching to this band using the frequency drop down menu in the Cat Bar.	Comments are preceded by a semi-colon (;)

This is the default entries for the MixW3.1.1h delivered bands.ini file for the 20 metre (14mhz) band.

; 20m band

20m SSB USB 14100 14350 14100 ; Defines the upper band limit

20m CW CW 14000 14350 14010 ;Defines the lower and upper band limits  
20m RTTY DEFAULT 14065 14112 14080  
20m BPSK31 DEFAULT 14065 14112 14070  
20m QPSK31 DEFAULT 14065 14112 14070  
20m FSK31 DEFAULT 14065 14112 14070  
20m PACKET DEFAULT 14065 14112 14105  
20m HELL DEFAULT 14065 14112 14062  
20m SSTV USB 14220 14240 14230  
20m ALL DEFAULT 14065 14112 14070

There are similar entries for most of the bands.

### **Adding a band**

To add the 4 metre (70mhz) band to the bands.ini file enter the following lines anywhere in the bands.ini file:

; 4m band

4m SSB USB 70000 70500 70000  
4m BPSK31 PKTR 70000 70500 70000  
4m CW CW 70000 70500 70000  
4m FM FM 70200 70500 70300  
4m ALL USB 70000 70500 70000

The frequencies are for the UK and the modes are those used for the Yaesu FT450, FT950, FT991, FTdx1200, Ft2000, FTdx3000, FTdx5000 and FTdx9000.

The entries do not have to be in any order and can be randomly scattered through the file. The requirement is they must all be started with the same characters (in this case 4m). The start characters are used by MixW at program load time to construct band tables and during normal operation to recognise the band from the frequency for use in the <OnEnterxx>, <OnLeavexx> and <BAND> macros.

### **Setting the Mode**

As delivered the digital mode entries in the bands.ini file are set to DEFAULT and this equates to the DEFAULT mode in the [CAT/PTT settings](#). Unfortunately the available values are not always suitable for the users transceiver (the FT450 for example) and are fixed. The CAT bar also has a drop down menu that displays the possible mode settings available for setting the transceiver and this menu is more representative of the possible settings available for the selected transceiver.

For more reliable mode selection in the CAT configuration set the Default digi mode to NONE and then set all the DEFAULT entries in the bands.ini file to whatever the setting is in the CAT bar menu for the transceiver when in each of the digital modes.

## **cty.dat File**

---

### **cty.dat**

The cty.dat file is used for Contests to assist in the generation of country multipliers from call signs. MixW also uses the entries to cross reference into the [pfx.dat](#) file to obtain possible further country information.

Each entry consists of multiple lines of data, the first contains 8 colon/space separated fields, the second and subsequent lines, are comma separated fields. The further data lines must start with a space and the last line is terminated by a semi-colon.

The eight fields of the first line are:

Country name:

CQ Zone:

ITU Zone:

Two letter continent:

Latitude: (a negative value is South)

Longitude: (a negative value is East. This is the opposite of the data in Personal Data)

Time difference from UTC:

Primary country prefix:

The subsequent lines are any of:

Further prefixes associated with this country

A Prefix or partial call followed by a figure in round brackets. This changes the CQ Zone for this prefix or partial call.

A Prefix or partial call followed by a figure in square brackets. This changes the ITU Zone for this prefix or partial call.

A prefix or partial call with both round and square bracketed figures. This changes both zones.

Up to MixW3.1.1g A complete callsign to be associated to this country. This call may have round or square brackets with it.

At MixW3.1.1h a complete callsign preceded by the equals sign to be associated with this country. This change has been made as other ham software packages had been written expecting it.

A copy of this file is delivered with the MixW software.

This file is regularly updated to reflect country changes, individual call location changes and other special event callsigns. For MixW there are two versions of the file, a version for use up to MixW3.1.1g and another version for use with MixW3.1.1h.

The version of cty.dat installed and in use by MixW can be identified by entering VERSION as the current QSO callsign. The country that is displayed changes for each version.

A release note with the cty.dat file indicates which country will be identified by the VERSION callsign.

The latest version of the file and more information can be found at:

<http://www.country-files.com/>

There is also a big copy of this file. It will only work with MixW3.1.1h. For more information on the big cty.dat file see:

<http://www.country-files.com/bigcty/index.htm>

## Initialisation File

---

**The initialisation file must NOT be a read only file. If it is any changes made during a MixW operating session will be lost.**

**MixW2.ini** is the default name given to the file MixW uses at program load time to customise the MixW session.

This file is read by MixW at program launch time. It contains most of the data used to configure the

system at start up.

MixW updates this file at exit time.

The first time MixW is started after installation this file will be created as a skeleton file. [Configuration](#) of MixW will set up values in the data saved by MixW at exit time pertaining to the current MixW set up.

It is quite permissible to have a number of different MixW initialisation files on your system. MixW2.ini is the default name and its default location is in the data files directory of the MixW installation. Prior to MixW2.2 the only way to change the MixW2.ini file was to copy a different file into the default MixW directory. There are now two ways to use a different MixW2.ini file:

From MixW2.2 on there is a file MixW2Startup.cfg. This file consists of two lines:

```
[Inifile]
Filename=C:\radio\mixw311h\Mixw2.ini
```

To change the name and/or the location of the file either:

use a text editor, use the menu File->Save config... (to write the MixW configuration to a new file name or location) which brings up a standard windows file selection box or use menu File->Load config... (to read the MixW configuration from a different file name or location). If writing a file the file will not be written until MixW shutdown but the MixW2Startup.cfg file is changed immediately.

or at MixW3.1.1

a [parameter](#) (INI:) at startup can be used to select a different .ini file.

The file consists of a number of section heading lines enclosed in square brackets followed by individual lines that consist of a parameter name followed by an equals character followed by the value assigned to the parameter.

A large number of the parameters are of no interest and their names are incomprehensible. The following is the Spectrum section from the MixW2.ini file with the System Info section showing the end of the Spectrum section:

```
[Spectrum]
ScaleBkg=0
Width=1
HorizSpectrums=0
Line=4227327
AverageInverted=0
Grid=0
DynRange=80
ScaleColor=16777215
TwoSpectrums=0
Type=3
AverageWidth=1
Sensitivity=2
GridColor=8421504
ShiftPx=0
AverageLine=16776960
Background=0
[System Info]
Data=406d3d0ad723951be440
MixW=3.1.1
```

System=Microsoft Windows 7 Home Premium ver 6.1 Service Pack 1 (build 7601)

The TwoSpectrums line can be changed by the parameters at MixW load time (see [Starting MixW Parameters](#) table). This line could also be edited, using a text editor (notepad.exe, wordpad.exe or your favourite editor) to change the parameter value to be 0 (one spectrum/waterfall display) or non-zero (two spectrum/waterfall displays).

**Before starting to edit the MixW2.ini file ensure you have a working copy of your MixW2.ini file.** If you haven't and make a mistake you will have to restart MixW with no MixW2.ini file which means you will have to reconfigure MixW.

There are a number of lines in MixW2.ini that can be changed by text editor to improve MixW useability:

m\_iCatDelay=0 in [Cat]

MixW actions the CAT continuously. As soon as 1 command is finished the next is sent. The value is in milliseconds and slows the CAT polling down.

isMinimized=1 in [Window]

If MixW is exited whilst it is minimized. On restart MixW is minimized but when the window is restored the Rx, Tx and CAT bars are in the wrong positions and wrong sizes. Either find an archive of MixW2.ini with isMinimized=0, use a text editor or script file to remove the line or restore the windows after loading.

MaxRxFines=360 in [Misc]

This is the number of lines available for scrolling back in the RX window. It can safely be increased to 3000 if the user needs the extra data to be available.

QrzPage=http://qrz.com/db/ in [WEBCLUSTER]

There are two menus in the log display that have an option to call QRZ.COM to display further information about the selected call sign. This line defines the web address that will be called on selection of qrz. This address can be changed if required.

AutoSavePath=C:\radio\mixw311h\AutoSavedPictures in [SSTV]

Defines the directory MixW will use to save SSTV pictures if the Auto Save option is checked.

A number of initialisation lines are described in other sections of these help files:

[SSTV Operation section](#). See this section for a description of what the parameters do and why they may be changed.

[Log Bar layout section](#). See this section for a description of what parameters to change to alter the Log Bar layout.

## Master.dat File

---

The Master.dat file provides a database of callsigns.

The original and still the main intention is to provide assistance to contesters enabling partial callsigns to be recognised or as a check for duplicate QSOs (see <http://www.supercheckpartial.com/> for more information and to download the **master.dta** file) However a file has been created with, supposedly, all the callsigns held in the qrz.com database. This provides assistance to recognising valid callsigns and looking for pirates.

The master.dat file consists of entries of just a callsign separated by a single NULL (hexadecimal 00) character.

MixW however can process and successfully use a file where the callsigns are separated by other separator characters, or character sequences. These include the space character, the carriage return/linefeed combination and tab character.

The master.dat file can be created locally by the user or the file master.dta downloaded from <http://www.supercheckpartial.com/>. The downloaded file, master.dta, must be renamed master.dat and checked to ensure it is not a blocked file.

A blocked file can be identified by opening Windows Explorer, selecting the file and right clicking. Select properties from the drop down menu. If a button marked Unblock is visible in the Attributes section of the properties display box this file is blocked. Left click on the Unblock button and then click on OK to unblock the file.

### Warning:

As the size of the Master.dat file increases the longer it takes to load. The method of electing to use Master.dat is to select menu View|Quick search>Use master file. Once this selection is made MixW now reads in the master.dat file, which must be loaded in the default data directory. During the read file process MixW will not respond to any other commands. Thus the longer it takes to read the file the longer MixW appears frozen, or to have crashed. To read a 10mb file takes at least 7 minutes on a modern fast PC. The number of processor cores is immaterial.

## Log Files

---

MixW creates a log file as part of its initial set up. The default file name is MixW2.log, the default format is csv and the default location is in the data files directory of MixW.

Up to MixW2.19 the only format was CSV. However since MixW2.2 four formats are offered CSV, MDB (Microsoft Access Database file), MYSQL (MySQL file) or Web based.

MixW2 csv log contains a number of lines, each of which contains 26 semi-colon (;) separated fields.

A number has been assigned to each position for reference. It does not appear in the log data.

Posn	Field	Description	Custom1.d at Field Ref no.
1	MYCALL	As in <MYCALL> macro.	
2	CALL	As in <CALL> macro.	6

3	Date/Time	A combined date and time. Set when CALL field populated or when <SETTIME> macro executed. Time is as per the UTC setting (UTC or local).	4 5
4	Duration	A value in seconds from when the Date/Time field was set to the time the QSO is saved.	*
5	QSLs	Date QSL Sent.	
6	QSLR	Date QSL received.	
7	RXFQ	The receiver QSO frequency (includes any offset on the waterfall).	2
8	TXFQ	The transmitter QSO frequency if different from the RXFQ. 0 if no difference.	3
9	DxPfx	The corrected country for the callsign if it has been changed in the Edit QSO box.	
10	MODE	As in <MODE> macro	1
11	RSTS	As in <RSTS> macro.	7
12	RSTR	As in <RSTR> macro.	9
13	NRS	As in <NRS> macro.	8
14	NRR	As in <NRR> macro.	10
15	NAME	As in <NAME> macro.	11
16	QTH	As in <QTH> macro.	12
17	NOTES	As in <NOTES> macro.	13
18	DOMAIN	The Domain field in the Edit QSO box.	14
19	MANAGER	The Manager field in the Edit QSO box.	17

20	COUNTY	The County field in the Edit QSO box.	15
21	IOTA	The IOTA field in the Edit QSO box.	16
22	LOC	As in <LOC> macro.	20
23	QSL MSG	The QSL Msg field in the Edit QSO box. This field is the field displayed by eQSLs.	
24	eQSLs	The date an EQSL is logged as being sent.	
25	eQSLR	The date an EQSL is logged as being received.	
26	CUSTOM	The Custom field in the Edit QSO box.	

**Field 4 Note:** The duration field is used with the Date/Time field to calculate the log displayed End Date and End Time fields (18 & 19 in Custom1/2.dat) in the log displayed in the Mixw main window.

The **MDB and MYSQL** versions of the log file, default names MixW2.mdb or MixW2.sql contains an enhanced number of fields.

To run the MYSQL database it is necessary to be able to log into a system running MYSQL. This can be on the local pc or a remote system.

The default database files can be found in:  
for XP:

c:\documents and settings\all users\mixw

for Vista, Windows 7, Windows 8 and Windows 10 a linked folder:

c:\program data\mixw

c:\users\all users\mixw

**Note:** a linked folder means a change to the contents of any of the folders is reflected through to the other linked folders.

MDB and SQL fields:

Posn	Field	Description	Custom1.d at Field Ref no.
1	QSO_ID	QSO number in this log.	
2	MyCall	As in <MYCALL> macro.	



3	Call	As in <CALL> macro.	6
4	StartTime	Set when CALL field populated or when <SETTIME> macro executed. Time is as per the UTC setting (UTC or local).	4 5
5	EndTime	Set when the QSO is saved..	18 19
6	QslSent	Date QSL sent.	
7	QslRcvd	Date QSL received.	
8	FqRx	The receiver QSO frequency (includes any offset on the waterfall).	2
9	FqTx	The transmitter QSO frequency.	3
10	DxPfx	The corrected country for the callsign if it has been changed in the Edit QSO box.	
11	Mode	As in <MODE> macro	1
12	RstSent	As in <RSTS> macro.	7
13	RstRcvd	As in <RSTR> macro.	9
14	ExchgSent	As in <NRS> macro.	8
15	ExchgRcvd	As in <NRR> macro.	10
16	Name	As in <NAME> macro.	11
17	QTH	As in <QTH> macro.	12
18	Info	As in <NOTES> macro.	13
19	Dom	The Domain field in the Edit QSO box.	14
20	QslTo	The Manager field in the Edit QSO box.	17
21	County	The County field in the Edit QSO box.	15

22	Iota	The IOTA field in the Edit QSO box.	16
23	WWLoc	As in <LOC> macro.	20
24	QslInfo	QSL Message field.	
25	EQslSent	The date an eQSL was sent.	
26	EQslRcvd	The date an eQSL was received.	
27	Custom	The Custom field in the Edit QSO box.	
28	ITUZ	ITU Zone.	
29	CQZ	CQ Zone.	
30	Country	Country name.	
31	CONT	Two letter continent (as found in the cty.dat file).	

To change the log between formats, before making any changes to the log name or type [export all the QSOs you want in the new log to an ADIF file](#). Then after changing the log file type in menu Configure| Personal Details import the ADIF file you just created into the new log file.

**Note**

- MixW does not automatically copy QSOs between log file types.
- The ADIF file transfer does not copy the Custom, DxPfx, QslInfo or eQSL Sent/Rcvd fields.

## **pfx.dat**

---

The pfx.dat file provides further information about the current QSO call sign prefix. This information supplements the information in [cty.dat](#).

The file format is similar to the cty.dat format.

Each entry consists of multiple lines of data, the first contains 8 colon/space separated fields, the second and subsequent lines, are comma separated further data pertaining to the country prefix. The further data lines must start with a space and the last line is terminated by a semi-colon. The eight fields of the first line are:

Additional Name:  
CQ Zone:  
ITU Zone:  
Two letter continent:  
Latitude: (-ve is South)  
Longitude: (-ve is East. This is the opposite of the data in Personal Data)  
Time difference from UTC:  
Primary country prefix:

The subsequent lines are callsign or partial callsigns to be associated with the first line data.  
The partial callsigns will contain wildcards. ? for a single character and \* to the end of the call

This file is delivered with the MixW software. It will be updated if the QSO details, Change button, Change Rule sequence is entered and a new call area is added. When a change is being written MixW displays a warning message box.

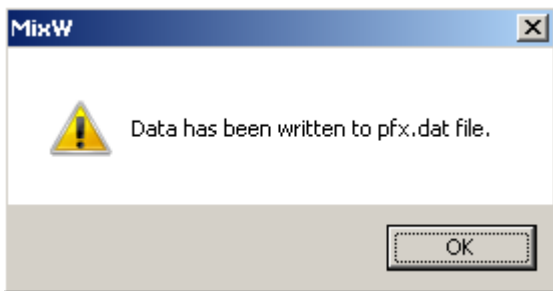

## HF Digital Modes Band Plan

---

### General HF Digital Band Plan

There is little consensus right now on which modes are acceptable in certain portions of the digital mode sub-bands. The influx of new digital modes and operators is not welcome by some. Please make every effort to avoid interference with other modes.

To see the official band plans for all three IARU Regions see:

[http://www.iaru-r2.org/hf\\_e.htm](http://www.iaru-r2.org/hf_e.htm)

The ARRL maintains "The Considerate Operator's Frequency Guide" for the United States at:

<http://www.arrl.org/considerate-operator>

In order to keep up with some of the current ideas you could join the email reflector at:

[http://groups.yahoo.com/group/DigiMode\\_HF\\_Band\\_Plans/](http://groups.yahoo.com/group/DigiMode_HF_Band_Plans/)

### Common Operating Frequencies for Specific Digital Modes

Specific frequencies for the digital modes change often as new modes are introduced, and general purpose lists are frequently out of date or incorrect. Your best bet is usually to search the Yahoo discussion groups for "digital radio" or the specific mode you are interested in. By joining the discussion groups and "reading the mail" for a few weeks you will usually see questions and answers about the best places to find a particular mode. A good place to start is:

<http://groups.yahoo.com/group/digitalradio/>

# Keyboard Shortcuts

---

These key combinations are for MixW3.1.

## **Standard Windows Edit Key Combinations used by MixW**

Ctrl-A - Select All  
Ctrl-C - Copy  
Ctrl-P - Print  
Ctrl-V - Paste  
Ctrl-X - Cut  
Ctrl-Z - Undo  
Home - Go to the start of the line  
End - Go to the end of the line  
Shift-Home - Highlight text from cursor position to the start of the line  
Shift-End - Highlight text from the cursor position to the end of the line

## **Ctrl Key combinations used by MixW**

Ctrl-S - Swap Windows  
Ctrl-> - Increase Audio Frequency by 10hz  
Ctrl-< - Decrease Audio Frequency by 10hz

Ctrl-Shift-P - Add QSO to the Print Queue

Ctrl-Alt-c - In Packet mode initiate Connect Dialogue.

Ctrl-1 to Ctrl-0 are used to write the current Mode/Frequency to Memory locations 1-10  
Ctrl-Shift-1 to Ctrl-Shift-0 write the current Mode/Frequency to Memory locations 11-20

## **Alt Key Combinations used by MixW**

Alt-A - Start Auto CQ  
Alt-D - Show QSO details from the currently selected Log Bar window entry  
Alt-E - If Log is displayed from the Search Dialogue: Edit currently selected QSO in the Log display  
          If log is not displayed: Show Edit Menu.  
Alt-F - Set Frequency from CAT Bar  
Alt-H - Show Help Menu  
Alt-I - Show File Menu  
Alt-M - Show Mode Menu  
Alt-O - Clear QSO data  
Alt-P - Show Options Menu  
Alt-Q - Toggle display of DX Cluster Window On/Off  
Alt-R - Display Search in Log dialogue box  
Alt-S - Save current QSO  
Alt-T - Toggle display of Telnet Window on/off  
Alt-U - Show Configure Menu  
Alt-V - Show View Menu  
Alt-W - Toggle between Spectrum and Waterfall display  
Alt-X - Go to Transmit  
Alt-Z - Toggle between Transmit and Receive  
Alt-> - Increase Audio Frequency by 1hz  
Alt-< - Decrease Audio Frequency by 1hz

Alt-1 to Alt-0 are used to read the stored Memory locations 1-10  
Alt-Shift-1 to Alt-Shift-0 read Memory locations 11-20

### **Other Keys used by MixW**

Pause/Break - Toggle between Transmit and Receive  
Esc - Puts MixW into Receive

### **Macro Keys**

The keys F1 to F12 select one of 12 [Macros](#). The Ctrl, Shift and Ctrl-Shift keys are used in combination with the 12 function keys to give further 12 key selections of macros.

The maths keys Ins, Gray/, Gray\*, Gray+ and Gray- give a further 5 macros.

This gives a total of 53 macros available at any one time.

If the keyboard has Multimedia keys these keys may be programmed with further [macro commands](#).

## **Macro Commands**

---

### **The following Macro commands are available in MixW:**

#### **Text**

<CALL> - Insert the callsign of other station as in log  
<NAME> - Insert the name of the other station operator as in log  
<QTH> - Insert the QTH of the other station as in log  
<WWLOC> - Insert the station locator  
<RSTR> - Insert received RST  
<RSTS> - Insert sent RST  
<NOTES> - Insert the Notes field as in the log  
<NRR> - Insert Exchange received  
<NRS> - Insert Exchange to send  
<DATE> - Insert the current date  
<TIME> - Insert the current UTC time  
<LOCALTIME> - Insert current local time  
<STARTTIME> - Insert QSO start time  
<CTIME> - Insert time in HHMM format  
<MYCALL> - Insert your callsign as configured in Personal Data  
<MYMAINCALL> - Insert your callsign without /P etc  
<MYNAME> - Insert your name as configured in Personal Data  
<MYQTH> - Insert your QTH as configured in Personal Data  
<MYWWLOC> - Insert your locator configured in Personal Data  
<PREVCALL> - Insert other station Callsign of last QSO saved  
<PREVCTIME> - Insert <CTIME> of last contest QSO saved  
<PREVNAME> - Insert other station Name of last QSO saved  
<PREVNRR> - Insert Exchange received of last QSO saved  
<PREVNRS> - Insert Exchange sent of last QSO saved  
<PREVQTH> - Insert other station QTH of last QSO saved  
<PREVRSTR> - Insert received RST of last QSO saved

<PREVRSTS> - Insert sent RST of last QSO saved  
 <SELCALL> - Insert other station Callsign of selected logged QSO  
 <SELNAME> - Insert other station Name of selected logged QSO  
 <SELNRR> - Insert Exchange received of selected logged QSO  
 <SELNRS> - Insert Exchange sent of selected logged QSO  
 <SELQTH> - Insert other station QTH of selected logged QSO  
 <SELRSTR> - Insert received RST of selected logged QSO  
 <SELRSTS> - Insert sent RST of selected logged QSO  
 <CR> - Insert Carriage Return  
 <CRLF> - Insert Carriage Return then Line Feed  
 <LF> - Insert Linefeed  
 <CTRL-x> - Insert Ctrl-A - Ctrl-Z (as defined by x)  
 <TAB> - Insert tab symbol (same as tab key)  
 <[> - Insert < character  
 <]> - Insert > character  
 <GA> - Insert GM GA or GE depending on time at Call station  
 <GAL> - As <GA> but use long phrase (Good Morning, Afternoon or Evening)  
 <IMD> - Insert the current IMD if IMD is fixed on the statusbar  
 <KHZ> - Insert current frequency in Khz  
 <KHZ:n> - Insert current frequency in Khz to n decimal places  
 <MHZ> - Insert current frequency in Mhz  
 <MHZ:n> - Insert current frequency in Mhz to n decimal places  
 <BAND> - Insert current Band  
 <MODE> - Insert current mode  
 <QSOBEFOREDATE> - Insert previous QSO for this band and mode date  
 <QSOBEFORETIME> - Insert previous QSO for this band and mode time  
 <ANYQSOBEFOREDATE> - Insert date of last QSO with this call  
 <ANYQSOBEFORETIME> - Insert time of last QSO with this call  
 <ANYQSOBEFOREBAND> - Insert band of last QSO with this call  
 <ANYQSOBEFOREMODE> - Insert mode of last QSO with this call  
 <QSONR:BAND> - Insert this band QSO number  
 <QSONR:MODE> - Insert this mode QSO number  
 <QSONR> - Insert this QSO number  
 <TXTIME> - Insert the elapsed time of transmission of the previous message  
 <WX> - Insert weather data as input with <WX?>  
 <MILES> - Insert distance in miles  
 <DIST> - Insert Distance in km  
 <AZ> - Insert azimuth  
 <CWID> - Insert CWID  
 <CWID:DEFAULT> - Set CWID as defined in Personal Data  
 <CWID:text> - Set CWID to text  
 <FILE> - Insert contents of file (opens file selection dialogue)  
 <FILE:filename> - Insert contents of filename  
 <TEXTFILE> - Insert text from file (opens file selection dialogue)  
 <TEXTFILE:filename> - Insert text from file filename  
 <RANDOM:filename> - Insert random string from a file. Designed to simulate live typing  
 <INIFILE:file,section,name> - Insert data from inifile  
     file *FILE*, section [*SECTION*], name *Name*=  
 <VER> - Insert Version Number

---

## Program

<TX> - Switch to TX mode immediately  
 <TXE> - Switch to TX mode when the RX carrier drops  
 <TXTOGGLE> - Toggle between TX and RX  
 <RX> - Switch to RX when encountered in the TX data stream

<RXANDCLEAR> - Switch to RX when encountered in the TX data stream and clear TX window  
<RXC> - Same as <RXANDCLEAR>  
<RXE> - Switch to RX mode when all TX data is transmitted  
[<ACALL>](#) - [Allows call changing on the fly](#)

The Call in the log maybe changed at any time up to the start of transmission of the call.

<CLEARQSO> - Erase the data in the current QSO line  
<CLEARRXWINDOW> - Clear RX window  
<CLEARTXWINDOW> - Clear TX window  
<CLEARWINDOW> - Clear current window  
<CURSOR:n> - Position cursor at field n of the log file  
<CURSOR:TX> - Position the cursor in the TX window  
<DTMF:abcd> - Send DTMF sequence  
<ESCAPE> - Same as escape key  
[<EXEC:program>](#) - Execute a program and continue  
[<EXT:command>](#) - Run an external program or command and wait until the action terminates  
<FILTER:name> - Turn filter on  
Filters available are NONE, PASS, NOTCH, NOISE  
<FIXSTARTTIME> - Set current time as QSO start time in log  
<GRABCALL> - Grabs calls from stack  
<LASTCALL> - Grabs the last call received  
<SHOW:name> - Show Toolbar  
<HIDE:name> - Hide Toolbar  
The following toolbars can be toggled with the SHOW and HIDE Macros:  
CONTROLBAR, LOGBAR, CATBAR,  
TUNINGBAR, TNC, WORLDMAP,  
STATUSBAR, DXCLUSTER, CALLBOOK,  
BEACON, TELNET, CONTESTSTATS, QUICKSEARCH  
<INPUTVOLUME> - Set the soundcard input volume using the Windows Volume Control  
<OUTPUTVOLUME> - Set the soundcard output volume using the Windows Volume Control  
There maybe problems with <INPUTVOLUME>  
and <OUTPUTVOLUME> in the latest windows versions  
<MARKERS:xx,yy,...> - Add marker lines to the waterfall/spectrum at xx,yy etc (up to 5) fq  
<MARKERS:OFF> - Remove all marker lines  
<MODE:mode> - Set mode to MixW mode  
<MODEADD:mode> - Set mode to additional mode  
<MODETNC:mode> - Set mode to TNC mode  
<NEWRXWINDOW:audiofq:mode> - Create RX mode window at audiofq  
<NEWRXWINDOW:audiofq> - Create RX current mode window at audiofq  
<NEWRXWINDOW> - Create new RX window in current mode and fq  
<CLOSERXWINDOWS> - Closes all secondary RX Windows  
<PTTOFF> - Switch PTT off  
<PTTON> - Switch PTT on  
<PTTSWITCH> - Toggle the PTT  
<BEEP:OFF> - Turn the PC Beep off  
<BEEP:ON> - Sound the PC Beep  
<SAVEQSO> - Save QSO data. Make sure this macro comes before any 'Clear' macros.  
<SCRIPT:filename> - Run script from filename  
<ASSCRIPT> - Run following text as a script file  
<TELNETSCRIPT:filename> - Run filename as telnet script  
<TNCSCRIPT:filename> - Run script for 2nd TNC from filename  
[<SEEKLEFT>](#) - Initiate a seek left  
[<SEEKRIGHT>](#) - Initiate a seek right

<SENDEQSL> - Send current QSO to eQSL. Prompts for password.  
This macro must come before a SAVEQSO or any 'Clear' macros.

<SENDEQSLNP> - Send current QSO to eQSL with no prompt.  
Same restrictions as <SENDEQSL>

<QSLPRINT> - Add current QSO to the QSL print queue.  
Same restrictions as <SENDEQSL>  
Use QSLprint to print card or label

<REPLAY> - Replay the sound history

<REPLAY:n> - Replay n seconds of the sound history

<STARTRECORD> - Start a wav recording

<STARTRECORD:filename> - Start wav recording to filename

<STARTRECORD:filename.mp3> - Start mp3 recording to filename (requires lame\_enc.dll)

<STARTRECORD2> - Start wav recording from 2nd Spectrum/Waterfall

<STOPRECORD> - Stop recording

<SAVESH> - Save the last 40 seconds of sound history.  
Brings up file selection dialogue box.

<SAVESHAUTO> - Save the last 40 seconds of sound history  
into a file with a name of the format shYYMMDDHHMISS.wav

<WAVE:filename> - Play filename as a .wav file

[<RXLOGSTART>](#) - Start RXLog (opens RXLog file select dialogue)

[<RXLOGSTART:filename>](#) - Start RXLog using filename

[<RXLOGSTOP>](#) - Stop RXLog

<SNAPNOW> - Do snap now

<STARTSCAN> - Starts the scan feature

<STOPSCAN> - Stops the scan feature

<TOGGLECATPORT> - Toggle the CAT port Enable/Disable

<TOGGLEPTTPORT> - Toggle the PTT port Enable/Disable

<TOGGLESOUNDDEV> - Toggle the sound device Enable/Disable

<TUNE> - Send a tuning signal (ESC key aborts)

<TUNE:nn> - Send a tune signal for nn seconds

<WKDIGNOREBEFORE:date time> - QSO is ignored before specified time

<WKDPERIOD:nn> - QSO is ignored until nnn minutes has elapsed

<CAPITALSONLY:x> - Switch capitals only (x = 1 on, x = 0 off)

<WORDMODE:x> - Switch word mode (x = 1 on, x = 0 off)

<SHOW:RIGEXPERTS> - Display Rigexpert devices connected to PC

<YAPPRECV> - YAPP receive

<YAPPSEND:filename> - YAPP send filename

<YAPPSEND> - YAPP send

<ALERT:text> - Display message box with text. Need to action OK to continue

<SENDSPOT> - Send spot to DX cluster if DX cluster is open

<GOOGLEEARTH:<SELCALL>> - Display map position of selected logged QSO call

<GOOGLEEARTH:<CALL>> - Display map position of current QSO call

[<LANG\\_>](#) - Change name of a macro depending on current callsign

---

## Frequency

<FQ:fq\_in\_kHz> - Set the transceiver frequency (use +/- for relative change)

[<FQB:fq\\_in\\_kHz>](#) - Set the transceiver VFO B frequency

<ZFQ:fq\_in\_kHz> - Set the transceiver zero-beat frequency (use +/- for relative change)

<JUMPTOTXFQ> - RX frequency jumps to TX frequency

<ALIGN:fq\_in\_Hz> - Aligns on the specified audio frequency

<AUDIOFQ:fq\_in\_Hz> - Sets the audio frequency (use +/- for relative change)

<BOOKMARK> - Toggles the Bookmark on/off

<BMERASE> - Clears all marks on this frequency

<CATCMD:text\_command> - Sends the text command to the transceiver



<CATCMDDE:text\_command> - Sends text via DDE  
<CATCMDHEX:hex\_command> - Sends the hex command to the transceiver  
<CATENABLEVFO SYNC> - Enable VFO sync  
<CATDISABLEVFO SYNC> - Disable VFO sync  
<CATVFO SYNC SHIFT:shift> - Set VFO B to VFO A +/- shift value.  
Use <CATDISABLEVFO SYNC> to stop this command.  
<CATVFO SYNC CONCE:fq> - Set VFO B to fq khz (use +/- for relative change)  
<CATTRANSVERTER:(+/-)shift\_in\_hz> - Allows working with different Transverters  
<CATWAIT:ms> - CAT delay in ms  
<SPSHIFT:fq\_in\_Hz> - Sets the spectrum or waterfall shift  
<SPZOOM:n> - Set the spectrum or waterfall zoom (0.5, 1, 2, 3, 4 are available)  
<MEMW:n> - Save certain settings to memory number n (1-20)  
<MEMR:n> - Restore settings from memory number n  
<SPLIT:1> - Put the transceiver into split mode working  
<SPLIT:0> - Restore the transceiver to single frequency working

---

## Macros

<MACROS:filename> - Load macros from filename  
filename will be used as default macros (instead of MixMacros.ini)  
<MODEMACROS:filename> - Load macros from filename for this mode  
This macro sets filename to store macros for this mode  
<EDITMACRO:name> - Edit macro with specified name  
This command brings Edit User Macro dialogue  
This command can be used to edit Event macros  
<HIDETEXT> - Don't show Macro text in window  
<SHOWTEXT> - Show Macro text in window  
<ONQSOBEFORE:name> - Run Macro name if QSO before  
<QSOCMDDE:command> - DDE command to external program  
<WX?> - Enter weather data that will be recalled by the <WX> macro

---

## Mode

<AFCON> - Switches AFC On  
<AFCOFF> - Switches AFC Off. See <LOCKRX> below  
<AFC> - Toggle AFC  
<INVON> - Turns invert on  
<INVOFF> - Turns invert off  
<INV> - Toggle invert  
<SNAPON> - Switches Snap on  
<SNAPOFF> - Switches Snap Off  
<SNAP> - Toggle Snap  
<SQUELCHON> - Switches squelch on  
<SQUELCHOFF> - Switches squelch off  
<SQUELCH> - Toggle squelch  
<LOCKRX> - Lock RX Frequency. Turns waterfall flag blue  
Does not inhibit AFC. RX fq may still wander  
<LOCKRXTOGGLE> - Toggle Lock RX  
<UNLOCKRX> - Unlock RX Frequency  
<LOCKTX> - Lock TX Frequency. Turns waterfall flag red  
<LOCKTXTOGGLE> - Toggle Lock TX  
<UNLOCKTX> - Unlock the TX Frequency  
<MODESETTINGS> - Displays mode settings dialogue box

<THRESHOLD> - Displays the Squelch dialog box

---

## Auto CQ

<ACQ> - Pause and restores AutoCQ mode

<ACQDELAY> - Set the AUTO CQ delay

<ALARM:string> - Beeps when string is received but see <OnAlarm> event macro

[<ASAUTO CQ>](#) - Initiate the following string as AUTO CQ

[<AUTO CQ>](#) - Initiates the auto CQ routine as set under Options | AutoCQ

<AUTOCQRESUME> - Resume an interrupted AUTO CQ

---

## Contest

<SP:0> - Run mode on (also <SP0>)

<SP:1> - Search and pounce mode on (also <SP1>)

<SP> - Switch to Run mode (same as SP:0)

<S/P> - Toggle between Search and Pounce and Run

<OnSP0> - Execute when switch to Run mode

<OnSP1> - Execute when switch to Search and Pounce mode

<STATS:GENERATEQTC> - Send 10 QTCs

<STATS:REPEATQTC> - Repeat the same 10 QTCs

<CLEARNRR> - Clear the NRR received field

<INCNRR> - Increment the NRR field if it is an integer

<INT> - Action depends on S&P or Run mode and content of CALL and NRR fields

<INTELLIGENT> - Same as <INT>

<INTQRL> - Called in S&P mode when Call is empty

<INTDE> - Called in S&P mode with a new call but NRR empty

<INTQSL> - Called in S&P mode with a new call and NRR complete

<INTCQ> - Called in Run mode when Call is empty

<INTGA> - Called in Run mode with a new call but NRR empty

<INTQB4> - Called in Run mode with a previous QSO call

<INTQRZ> - Called in Run mode with new call and NRR complete

<INTAGNCALL> - Request call sign again

<INTAGNNR> - Request exchange again

---

## Rotor

<ROTOR:LP> - Turn rotor to the Long Path for the station in the <CALL> field

<ROTOR:SP> - Turn rotor to the Short Path for the station in the <CALL> field

<ROTOR:n> - Turn rotor to the specified azimuth using n

<ROTORCMD:command> - Send command to the rotor port

<ROTORCMDHEX:command> - Send hexadecimal command to the rotor port

---

## CW

<LANGUAGE:xxx> - Select language

A language must have a corresponding xxx.cwt file

<FORCELANGUAGE:xxx> - Force receiving as xxx

<WPM:-n> - Decrease the CW speed by n

<WPM:+n> - Increase the CW speed by n

<WPM:n> - Set the CW speed to n  
<WPM:RX> - Match the TX speed to the RX speed  
<WKHEX:hex command> - Send hex command to WinKey  
<WKTEXT:text> - Send text to WinKey  
<WKPOT> - Enable WinKey pot  
<WKNOPOT> - Disable WinKey pot

---

## Hell

<SET FILTER:width\_in\_hz> - Set filter width  
<SET FONT:n> - Set the font to n  
<SET RXFQ:fq\_in\_hz> - Set the RX frequency  
<SET SCALE:n> - Set the scale  
<SET SUBMODE:submode> - Set the Hell submode (FELD, FM105, FM245)  
<SET TXFQ:fq\_in\_hz> - Set the TX frequency

---

## MFSK

<PIC:filename 00> - Sends filename in high resolution black and white  
<PIC:filename %C> - Sends filename in high resolution colour  
<PIC?N> - Same as selecting File->Send Picture->B/W..  
opens dialog box to select picture file, sends in black and white  
<PIC?N%C> - Same as selecting File->Send Picture-> Colour...  
opens dialog box to select picture file, sends in colour

---

## Olivia

<GET OFFSET> - Get frequency offset  
<GET RATE> - Get sample rate difference  
<GET SN> - Get s/n ratio  
<SET BW:n> - Set bandwidth in hz  
<SET TONES:n> - Set number of tones

---

## Contestia

<SET BW:n> - Set bandwidth in hz  
<SET TONES:n> - Set number of tones

---

## RTTYM

<SET BW:n> - Set bandwidth in hz  
<SET TONES:n> - Set number of tones

---

## RTTY

<LETTERS> - Forces letters  
<NUMBERS> - Forces numbers  
<SHIFT:shift\_in\_Hz> - Sets the RTTY shift in Hz

<BAUDRATE:baudrate> - Sets the baudrate

---

## SSTV

<FONTBOLD:n> - Set font bold (n=1 on, n=0 off)  
<FONTCOLOR:n> - Set font color  
<FONTFACE:name> - Set the font face name  
<FONTITALIC:n> - Set font italic (n=1 on, n=0 off)  
<FONTSIZE:n> - Set the font size  
<FROMCLIP> - Load picture from clipboard  
<LIMITSCANLINES:n> - Send only n lines  
<LOADPICTURE:filename> - Load picture with header  
<LOADPICTUREONLY:filename> - Load picture only  
<LOCKMODE> - Lock the SSTV mode  
<PLACETEXT:x:y:text> - Place text at position x,y  
<PLACETEXT:x:y> - Place cursor at position x,y  
<PUTHEADER:filename> - Put filename header file  
<PUTRXPICT:x0:y0:x1:y1> - Put received picture into the specified rectangle  
<TEXTSTYLE:n> - Set current text style  
<UNLOCKMODE> - Unlock current SSTV mode

---

## Event

<OnAlarm> - Execute after an <ALARM> event. Beep is cancelled  
<OnOpenTelnetWindow> - Execute after open of Telnet window  
<OnCloseTelnetWindow> - Execute after close of Telnet window  
<OnOpenTNCWindow> - Execute after open of TNC window  
<OnCloseTNCWindow> - Execute after close of TNC window  
<OnCRm> - Execute when Enter is pressed with focus in log field m  
<OnCR> - Execute when focus in log (also see <INT>)  
<OnSpace> - Execute when focus in call field and space bar is pressed  
<OnSpaceTXW> - Execute when focus is RX/TX/Waterfall area and space bar is pressed  
<OnStartMixW> - Execute when MixW starts  
<OnEndMixW> - Execute during close of MixW  
<OnStartMode> - Execute when mode is entered  
<OnEndMode> - Execute on leaving current mode  
<OnEnter#> - Execute when band# is entered (set in bands.ini file)  
<OnLeave#> - Execute when band# is exited (set in bands.ini file)  
<OnGrabCall> - Executed when call has been received (<GRABCALL> retrieves it)  
<OnGrabCallTx> - Execute when call is grabbed from keyer  
<OnGrabNumber> - Execute when (serial) number is grabbed  
<OnSaveQSO> - Execute when QSO is saved  
<OnRemoveQSO> - Execute when QSO is removed  
<OnRX> - Execute when RX is initiated  
<OnTX> - Execute when TX is initiated  
<OnEscape> - Execute when Escape key pressed  
<OM> - Execute if <NAME> is called and Name field in the log is empty  
<OnAPPCommandxx> - Execute when multimedia key xx is pressed  
<OnClickAny> - Execute when any of the selectable fields is transferred to the log  
<OnClickCall>; - Execute when the CALL is transferred to the log  
<OnClickLoc> - Execute when the Locator is transferred to the log  
<OnClickName> - Execute when the Name is transferred to the log  
<OnClickNr> - Execute when the Number is transferred to the log  
<OnClickQth> - Execute when the QTH is transferred to the log

<OnClickRst>; - Execute when the received RST is transferred to the log

Single/Double clicking the fields in the RX Window transfers them to the log. When this method is used to populate the log field the appropriate OnClick macro is executed

---

### Further explanation on the use of some of MixW's special Macro commands:

**OnEnter#** If, for example, you had a set of MARS macros defined in a file named MARS.mc, and you were working MARS in the 150 meter band, you would first define the 150m band in the bands.ini file, and then you could define the macro OnEnter150m as <MACROS:MARS.mc>.

**OnCRm** This macro tells MixW what to do if CR is pressed while focus is in the log in field m. If m is omitted it applies to any field. This macro is specified in the default macros dialog. Use with <CURSOR:n> macro to move the cursor to field n in the log.

Example: After entering Call (field 5) and hitting Enter you want the cursor to jump to the field Rx Exchange (field 9) then declare the macro OnCR5 as <CURSOR:9>.

**CWID:** To add a CW ID to the default signoff macro you must first define it under Personal Data. Select Configure | Personal Data. This brings up the personal data window. Check the "use CWID" box and then enter your sign off CW ID text, then uncheck this box to avoid sending the CWID when you don't want too. Next add <CWID> to the end of the macro, such as, 73 <CALL> DE <MYCALL> SK<CWID>. Of course, <CWID> can also be assigned to a separate function key, as can <TIME> and <DATE>, but MixW's log also logs the time and date automatically. If you use CW ID, keep in mind that while it is executing, the other station is printing only garbage. For that reason, you might want to use CW ID only at the end of your signoff macro.

### AUTO CQ:

Auto CQ is a very handy Macro that enables you to transmit a predetermined CQ sequence at regular intervals. It will stop automatically when a call sign is received (indicating that your CQ has been answered). AutoCQ must first be configured by selecting Options | Auto CQ | Text. It can then be configured just like any other Macro by using the following dialog box:

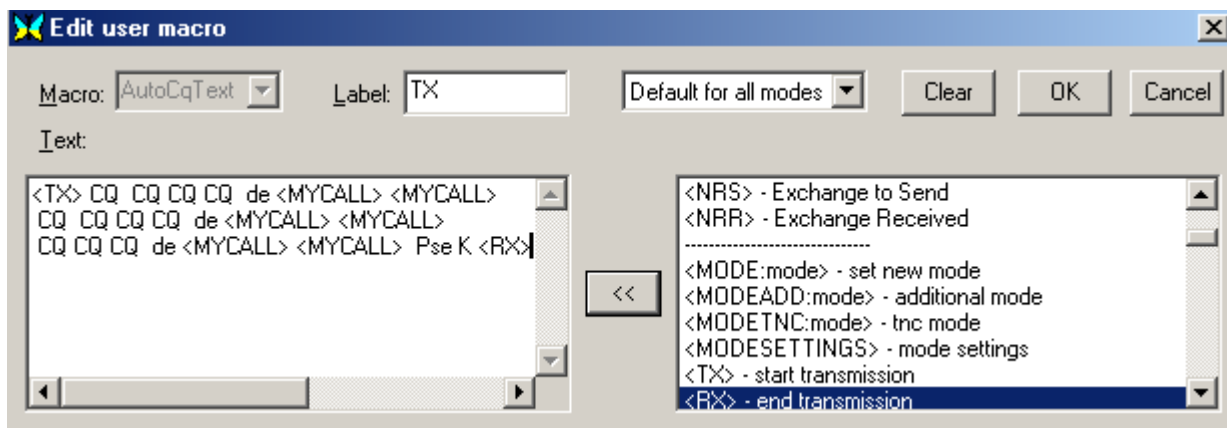

When you're done configuring this click OK to save it. Then select options | Auto CQ | Delay, which brings up the following box:

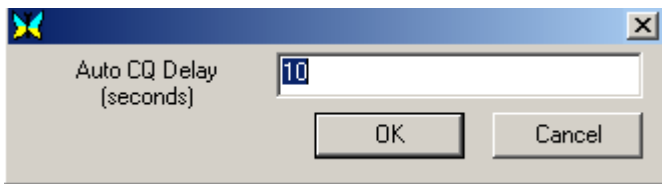

Enter the delay in seconds you want between your AutoCQ transmissions. Next simply assign <AUTOCQ> to one of your Macro Keys as any other Macro.

You can initiate AutoCQ in three ways: Click on the button you have assigned it to, depress the key you have assigned it to, or select Options | Auto CQ | Start. You will see the AutoCQ indication box appear above your cursor in the spectrum or waterfall display. AutoCQ will cycle until a call sign is received in the RX window, when it will automatically stop (MixW knows that your CQ has been answered!). You can manually stop AutoCQ by depressing the Escape Key, or by Selecting Options | Auto CQ | Stop.

By selecting Options | Auto CQ | and Watch squelch, AutoCQ will then only operate when your RX is squelched, thereby avoiding accidentally transmitting over the top of an existing QSO.

### <ASAUTOCQ>

Using this Macro command at the beginning of any Macro string will define it as the new AutoCQ text and commence to AutoCQ with it when selected. This enables MixW to have multiple AutoCQ strings. For instance you could define one for a contest or special event station, and still leave your default AutoCQ text for your normal operations.

### <WAVE:filename>

Plays the indicated \*.WAV file. This is very handy to use as a voice Keyer for contesting or otherwise calling CQ or other automated voice responses. Simply record wave files using the Windows Sound Recorder (included with Windows) or another digital recording program and save them as .WAV files. Then you can configure your Macros to replay your voice as recorded all automatically. For instance the following Macro would be used for calling CQ in a contest:

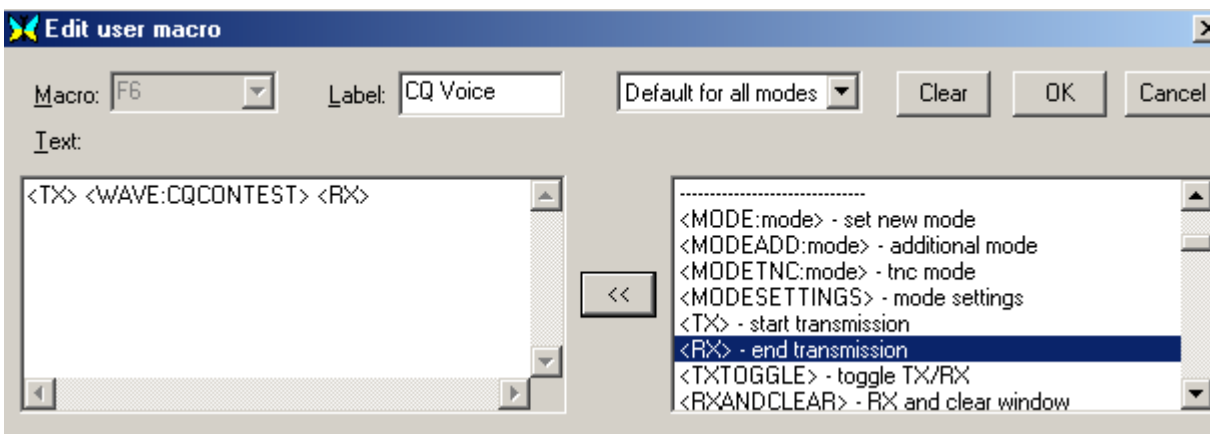

Where CQCONTEST is the name of the pre-recorded .WAV file of my voice saying, "CQ Contest CQ Contest CQ Contest CQ Contest, this is K4SET calling CQ Contest". For this Macro to work, you should be in SSB, AM, or FM phone modes. Then by initiating this Macro (by clicking on the button or depressing the F6 key in this case) MixW will automatically key your transceiver, then play your recorded voice calling CQ through the soundcard to your transceiver's input audio, then it will switch back to receive while you just sit by and listen for answers. You can likewise pre-record any number of other transmissions including reports or QRZ type end of contact calls. This can really save you voice during a long contest or special event operation.

**Note:** <WAVE:filename> can also be used in conjunction with your <AUTOCQ> or <ASAUTOCQ> Macros to use the voice keyer to automatically call CQ.

**<TEXTFILE:filename> - Inserts the indicated text file**

When creating or editing a text file (.txt) for use with a Macro, be sure that the file is terminated by hitting the "Enter" key on the computer keyboard. This will place a cr/lf at the end of the file. Without the "Enter" at the end the file will not be sent to the TX window, but will just produce an empty line.

**<INIFILE:file,section,name>** - insert a line from an ini-file.

Suppose I have a program that measures the temperature using a sensor outside of the house and periodically writes the value into d:\emp\ensor.ini file:

--- start of d:\emp\ensor.ini ---

[Sensor]

Temperature=xx

Humidity=yy

Illumination=zz

--- end of d:\emp\ensor.ini ---

Then I can make a macro:

The current temperature in Kiev is

<INIFILE:d:\emp\ensor.ini,Sensor,Temperature> degrees centigrade.

**<INIFILE:friend.ini,[HI],<CALL>>** - is a special application of the INIFILE macro for use with the friend.ini file.

The format of the friend.ini file is:

[HI]

UA4FCO=Yuri

DS4AEM=Cha

F5NBX=Meuzac

. . . etc. . .

One way to use this macro would be to combine it with the <OM> macro. To edit the OM macro go to Configure | Default Macros and change the Text to <INIFILE:friend.ini,[HI],<CALL>>. Now when you use the OM macro, if there is no name in the current log Name field, the Call will be looked up in the friend.ini file and the name found there will be transmitted. If the call is not found, nothing will be sent.

### **Use of <EXT> and <EXEC> macros**

Although both these macros can be used to execute windows commands and programs their behaviour can be different.

<EXT:dir> will execute the CMD.exe command dir on the current default data directory and put the output in the MixW TX window.

<EXEC:dir> will cause MixW to create an Error! message box informing 'Cannot execute dir!

<EXT:notepad> will execute notepad and MixW then halts and displays 'Not Responding' in the main MixW window title bar until the notepad window is closed.

<EXEC:notepad> executes notepad and then MixW continues.

The <EXEC:> cannot be used to execute an internal CMD.exe command directly. However a separate command window can be opened using <EXEC:cmd>.

### **MFSK Picture macro commands:**

A picture file of about 250 x 200 pixels can be sent using the following macro commands:

<PIC?N> - same as selecting File | Send Picture... | B/W...

opens dialog box to select picture file, sends in black and white

<PIC?N%C> - same as selecting File | Send Picture... | Color

opens dialog box to select picture file, sends in color

<PIC:filename.ext 00> - sends picture file in high resolution black and white

<PIC:filename.ext %C> - sends picture file in high resolution colour

See the MFSK Topic in the Digital Modes Section of this Help File for more information.

## Creating or Changing Macros

The macroname is the key combination (eg Shift-F8) or the event name not the label name.

New macros can be added or the contents changed by a number of different methods:

Use the MixW menu Configure->Default Macros (or Macros for this mode)

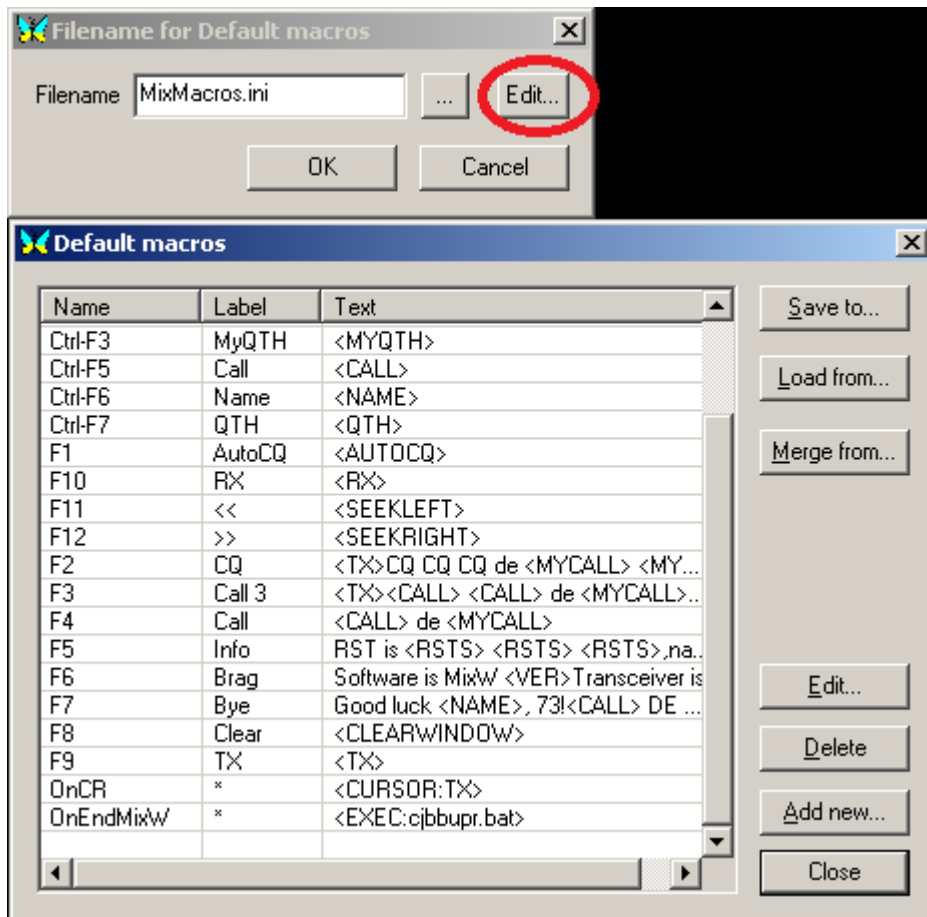
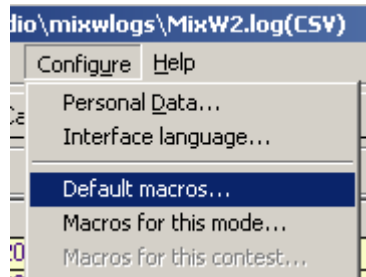

and select Add new or Edit from the macro selection box.

Right Click on the Macro button to bring up the Edit user macro box.

This method cannot be used to edit the 5 'Maths' key macros (Gray+, Gray-, Gray\*, Gray/ and INS), the Media keyboard macros, the Search and Pounce/Run integral macros nor the Event Macros.



Use the <EDITMACRO:macroname> macro

Use <macroname?>

This will bring up a small text input box. Input or change the text as required.

Using this method of creating or changing a macro has limitations. If you press the Enter key whilst the focus is in the text area the edit will terminate and the macro will be executed 'as is'. It is not possible to create extra lines for the macro being changed and if it is being created only one line is possible. However by use of <CRLF> multiple transmitted lines can be created.

Use <macroname> to execute the macro if it is being created/changed as an event macro

An example in the macro list is <WX?>

## **A WARNING**

If an attempt is made to use a text editor to edit the raw macro files it is possible Windows will 'corrupt' the file when it is written back. This will occur if a 'special' character (eg the temperature degree symbol) is included in a macro text. Some text editors write the data back and include special characters at the start of the file to identify there are special characters in the text, invisible to a text editor but confusing to MixW and the default macro set is now appended to the back of the macro file and the user has 'lost' their macros.

## **REMEMBER BACK UP ALL YOUR MACRO FILES.**

### **Alphabetical list of Macro Commands**

<[> - Text

<]> - Text

<ACALL> - Program

<ACQ> - Auto CQ

<ACQDELAY> - Auto CQ

<AFC> - Mode

<AFCOFF> - Mode

<AFCON> - Mode

<ALARM:string> - Auto CQ

<ALERT:text> - Program

<ALIGN:fq\_in\_Hz> - Frequency

<ANYQSOBEFOREBAND> - Text

<ANYQSOBEFOREDATE> - Text

<ANYQSOBEFOREMODE> - Text

<ANYQSOBEFORETIME> - Text

<ASAUTOCQ> - Auto CQ

<ASSCRIPT> - Program

<AUDIOFQ:fq\_in\_Hz> - Frequency

<AUTOCQ> - Auto CQ

<AUTOCQRESUME> - Auto CQ

<AZ> - Text

<BAND> - Text

<BAUDRATE:baudrate> - RTTY

<BEEP:OFF> - Program

<BEEP:ON> - Program

<BMERASE> - Frequency

<BOOKMARK> - Frequency

<CALL> - Text

<CAPITALSONLY:x> - Program

<CATCMD:text\_command> - Frequency  
<CATCMDDE:text\_command> - Frequency  
<CATCMDHEX:hex\_command> - Frequency  
<CATDISABLEVFOSYNC> - Frequency  
<CATENABLEVFOSYNC> - Frequency  
<CATTRANSVERTER:(+/-)shift\_in\_hz> - Frequency  
<CATVFOSYNCONCE:2xxxxx> - Frequency  
<CATVFOSYNCSHIFT:shift> - Frequency  
<CATWAIT:ms> - Frequency  
<CLEARNR> - Contest  
<CLEARQSO> - Program  
<CLEARRXWINDOW> - Program  
<CLEARTXWINDOW> - Program  
<CLEARWINDOW> - Program  
<CLOSERXWINDOWS> - Program  
<CR> - Text  
<CRLF> - Text  
<CTIME> - Text  
<CTRL-x> - Text  
<CURSOR:n> - Program  
<CURSOR:TX> - Program  
<CWID:DEFAULT> - Text  
<CWID:text> - Text  
<CWID> - Text  
<DATE> - Text  
<DIST> - Text  
<DTMF:abcd> - Program  
<EDITMACRO:name> - Macros  
<ESCAPE> - Program  
<EXEC:program> - Program  
<EXT:command> - Program  
<FILE:filename> - Text  
<FILE> - Text  
<FILTER:name> - Program  
<FIXSTARTTIME> - Program  
<FONTBOLD:n> - SSTV  
<FONTCOLOR:n> - SSTV  
<FONTFACE:name> - SSTV  
<FONTITALIC:n> - SSTV  
<FONTSIZE:n> - SSTV  
<FORCELANGUAGE:xxx> - CW  
<FQ:fq\_in\_kHz> - Frequency  
<FQB:fq\_in\_kHz> - Frequency  
<FROMCLIP> - SSTV  
<GA> - Text  
<GAL> - Text  
<GET OFFSET> - Olivia  
<GET RATE> - Olivia  
<GET SN> - Olivia  
<GOOGLEEARTH:<CALL>> - Program  
<GOOGLEEARTH:<SELCALL>> - Program  
<GRABCALL> - Program  
<HIDE:name> - Program  
<HIDETEXT> - Macros  
<IMD> - Text  
<INCNRR> - Contest

<INIFILE:file,section,name> - Text  
<INPUTVOLUME> - Program  
<INT> - Contest  
<INTAGNCALL> - Contest  
<INTAGNNR> - Contest  
<INTCQ> - Contest  
<INTDE> - Contest  
<INTELLIGENT> - Contest  
<INTGA> - Contest  
<INTQB4> - Contest  
<INTQRL> - Contest  
<INTQRZ> - Contest  
<INTQSL> - Contest  
<INV> - Mode  
<INVOFF> - Mode  
<INVON> - Mode  
<JUMPTOTXFQ> - Frequency  
<KHZ:n> - Text  
<KHZ> - Text  
<LANG\_> - Program  
<LANGUAGE:xxx> - CW  
<LASTCALL> - Program  
<LETTERS> - RTTY  
<LF> - Text  
<LIMITSCANLINES:n> - SSTV  
<LOADPICTURE:filename> - SSTV  
<LOADPICTUREONLY:filename> - SSTV  
<LOCALTIME> - Text  
<LOCKMODE> - SSTV  
<LOCKRX> - Mode  
<LOCKRXTOGGLE> - Mode  
<LOCKTX> - Mode  
<LOCKTXTOGGLE> - Mode  
<MACROS:filename> - Macros  
<MARKERS:OFF> - Program  
<MARKERS:xx,yy,...> - Program  
<MEMR:n> - Frequency  
<MEMW:n> - Frequency  
<MHZ:n> - Text  
<MHZ> - Text  
<MILES> - Text  
<MODE:mode> - Program  
<MODE> - Text  
<MODEADD:mode> - Program  
<MODEMACROS:filename> - Macros  
<MODESETTINGS> - Mode  
<MODETNC:mode> - Program  
<MYCALL> - Text  
<MYMAINCALL> - Text  
<MYNAME> - Text  
<MYQTH> - Text  
<MYWWLOC> - Text  
<NAME> - Text  
<NEWRXWINDOW:audiofq:mode> - Program  
<NEWRXWINDOW:audiofq> - Program  
<NEWRXWINDOW> - Program

<NOTES> - Text  
<NRR> - Text  
<NRS> - Text  
<NUMBERS> - RTTY  
<OM> - Event  
<OnAlarm> - Event  
<OnAPPCommandxx> - Event  
<OnClickAny> - Event  
<OnClickCall> - Event  
<OnClickLoc> - Event  
<OnClickName> - Event  
<OnClickNr> - Event  
<OnClickQth> - Event  
<OnCloseTelnetWindow> - Event  
<OnCloseTNCWindow> - Event  
<OnCR> - Event  
<OnCRm> - Event  
<OnEndMixW> - Event  
<OnEndMode> - Event  
<OnEnter#> - Event  
<OnEscape> - Event  
<OnGrabCall> - Event  
<OnGrabCallTx> - Event  
<OnGrabNumber> - Event  
<OnLeave#> - Event  
<OnOpenTelnetWindow> - Event  
<OnOpenTNCWindow> - Event  
<ONQSOBEFORE:name> - Macros  
<OnRemoveQSO> - Event  
<OnRX> - Event  
<OnSaveQSO> - Event  
<OnSP0> - Contest  
<OnSP1> - Contest  
<OnSpace> - Event  
<OnSpaceTXW> - Event  
<OnStartMixW> - Event  
<OnStartMode> - Event  
<OnTX> - Event  
<OUTPUTVOLUME> - Program  
<PIC:filename 00> - MFSK  
<PIC:filename %C> - MFSK  
<PIC?N%C> - MFSK  
<PIC?N> - MFSK  
<PLACETEXT:x:y:text> - SSTV  
<PLACETEXT:x:y> - SSTV  
<PREVCALL> - Text  
<PREVCTIME> - Text  
<PREVNAME> - Text  
<PREVNRR> - Text  
<PREVNRS> - Text  
<PREVQTH> - Text  
<PREVRSTR> - Text  
<PREVRSTS> - Text  
<PTTOFF> - Program  
<PTTON> - Program  
<PTTSWITCH> - Program

<PUTHEADER:filename> - SSTV  
<PUTRXPICT:x0:y0:x1:y1> - SSTV  
<QSLPRINT> - Program  
<QSOBEFOREDATE> - Text  
<QSOBEFORETIME> - Text  
<QSOCMDDDE:command> - Macros  
<QSONR:BAND> - Text  
<QSONR:MODE> - Text  
<QSONR> - Text  
<QTH> - Text  
<RANDOM:filename> - Text  
<REPLAY:n> - Program  
<REPLAY> - Program  
<ROTOR:LP> - Rotor  
<ROTOR:n> - Rotor  
<ROTOR:SP> - Rotor  
<ROTORCMD:command> - Rotor  
<ROTORCMDHEX:command> - Rotor  
<RSTR> - Text  
<RSTS> - Text  
<RX> - Program  
<RXANDCLEAR> - Program  
<RXC> - Program  
<RXE> - Program  
<RXLOGSTART:filename> - Program  
<RXLOGSTART> - Program  
<RXLOGSTOP> - Program  
<S/P> - Contest  
<SAVEQSO> - Program  
<SAVESH> - Program  
<SAVESHAUTO> - Program  
<SCRIPT:filename> - Program  
<SEEKLEFT> - Program  
<SEEKRIGHT> - Program  
<SELCALL> - Text  
<SELNAME> - Text  
<SELNRR> - Text  
<SELNRS> - Text  
<SELQTH> - Text  
<SELRSTR> - Text  
<SELRSTS> - Text  
<SENDEQSL> - Program  
<SENDEQSLNP> - Program  
<SENDSPOT> - Program  
<SET BW:n> - Contestia  
<SET BW:n> - Olivia  
<SET BW:n> - RTTYM  
<SET FILTER:width\_in\_hz> - Hell  
<SET FONT:n> - Hell  
<SET RXFQ:fq\_in\_hz> - Hell  
<SET SCALE:n> - Hell  
<SET SUBMODE:submode> - Hell  
<SET TONES:n> - Contestia  
<SET TONES:n> - Olivia  
<SET TONES:n> - RTTYM  
<SET TXFQ:fq\_in\_hz> - Hell

<SHIFT:shift\_in\_Hz> - RTTY  
<SHOW:name> - Program  
<SHOW:RIGEXPERTS> - Program  
<SHOWTEXT> - Macros  
<SNAP> - Mode  
<SNAPNOW> - Program  
<SNAPOFF> - Mode  
<SNAPON> - Mode  
<SP:0> - Contest  
<SP:1> - Contest  
<SP> - Contest  
<SPLIT:0> - Frequency  
<SPLIT:1> - Frequency  
<SPSHIFT:fq\_in\_Hz> - Frequency  
<SPZOOM:n> - Frequency  
<SQUELCH> - Mode  
<SQUELCHOFF> - Mode  
<SQUELCHON> - Mode  
<STARTRECORD:filename.mp3> - Program  
<STARTRECORD:filename> - Program  
<STARTRECORD> - Program  
<STARTRECORD2> - Program  
<STARTSCAN> - Program  
<STARTTIME> - Text  
<STATS:GENERATEQTC> - Contest  
<STATS:REPEATQTC> - Contest  
<STOPRECORD> - Program  
<STOPSCAN> - Program  
<TAB> - Text  
<TELNETSCRIPT:filename> - Program  
<TEXTFILE:filename> - Text  
<TEXTFILE> - Text  
<TEXTSTYLE:n> - SSTV  
<THRESHOLD> - Mode  
<TIME> - Text  
<TNCSCRIPT:filename> - Program  
<TOGGLECATPORT> - Program  
<TOGGLEPTTPORT> - Program  
<TOGGLESOUNDDEV> - Program  
<TUNE:nn> - Program  
<TUNE> - Program  
<TX> - Program  
<TXE> - Program  
<TXTIME> - Text  
<TXTOGGLE> - Program  
<UNLOCKMODE> - SSTV  
<UNLOCKRX> - Mode  
<UNLOCKTX> - Mode  
<VER> - Text  
<WAVE:filename> - Program  
<WKDIGNOREBEFORE:date time> - Program  
<WKDPERIOD:nn> - Program  
<WKHEX:hex command> - CW  
<WKNOPOT> - CW  
<WKPOT> - CW  
<WKTEXT:text> - CW

<WORDMODE:x> - Program  
<WPM:-n> - CW  
<WPM:+n> - CW  
<WPM:n> - CW  
<WPM:RX> - CW  
<WWLOC> - Text  
<WX?> - Macros  
<WX> - Text  
<YAPPRECV> - Program  
<YAPSEND:filename> - Program  
<YAPSEND> - Program  
<ZFQ:fq\_in\_kHz> - Frequency

## External Resources

---

### Using External Resources

MixW has a number of purpose written programs to enable it to be linked to external software packages both for sending and receiving data. There are also a number of inbuilt features available to allow any amateur programmers to develop their own custom solutions. See [Using MixW with other Programs](#) for a description of some of the available information.

### ProLog

A standalone logging program written and supported by DataMatrix. Has inbuilt support for MixW. See <http://www.prologsystem.com/> for more information.

### MixWLogger32.exe

This utility allows the MixW log to be used by the Logger32.exe logging software.

Download from Victor Kosobokov ( R3BB)'s site <http://www.digitalrus.ru/>

### Mixw2-dx-labs-gateway

Provides an interface between MixW and the DXLabs suite of ham radio software. See the download site <http://www.n2amg.com/software/mixw2-dx-labs-gateway/> for a full description of all that is available.

### MixWeblookup.exe

This utility allows the look up of callsigns from 4 different callsign holder websites plus an extra one for USA and Canadian callsigns.

The access policy of some sites now make it necessary to log in before the callholders data is available.

Download from <http://www.mixwusa.com/downloads.htm> or [the MixW Yahoo group files section](#) (membership necessary). **CBDLL**

An online Callbook DLL permitting callsign lookups from MixW to QRZ.COM.

See the download site <http://www.k1pgv.com/cbdll.html> for more information on all the facilities available.

### **MixWButtons.exe**

MixWButtons provides up to 100 extra Macro buttons which can be used in the same way as the 48 available MixW macro buttons.

See the download site <http://www.k1pgv.com/mixwbuttons.html> for more information on all the facilities available.

### **MixWBuddy.exe**

MixWBuddy is the precursor to MixWButtons.

See the download site <http://www.k1pgv.com/mixwbuddy.html> for more information on the features in this utility

### **JT-Alert**

This utility provides some access to the MixW log from JT65-HF.

See <http://hamapps.hamspots.net/> for more information on the features in this utility

### **MixW Facilities to Access External data**

#### **Using the <EXEC:> macro to access internet sites.**

If you wish to activate an internet site try using the macro:

```
<EXEC:"c:\program files\internet explorer\iexplore.exe" site to access>
```

The following macro will display the current qso call eQSL page (if one exists):

```
<EXEC:"c:\program files\internet explorer\iexplore.exe" www.eqsl.cc/member.cfm?><CALL>>
```

Other free callsign holding sites include:

[www.hamqth.com](http://www.hamqth.com)

[www.callook.info](http://www.callook.info) (USA only)

[www.rac.ca](http://www.rac.ca) (Canada only)

[www.qrz.com](http://www.qrz.com) (login required before callsign information is available)

[hamcall.net](http://hamcall.net)

You will need to find the path/program name for other browsers

The <EXEC:> macro can be used to activate almost any program on the computer. See [Use of <EXT> and <EXEC> macros.](#)

**Use of External Modes to Activate programs.** MixW has the ability to run modes externally, disabling the CAT, PTT and Soundcard if required. using these facilities it is possible to run any program. To enable another mode or other piece of software select Menu Modes|Additional Mode Settings...



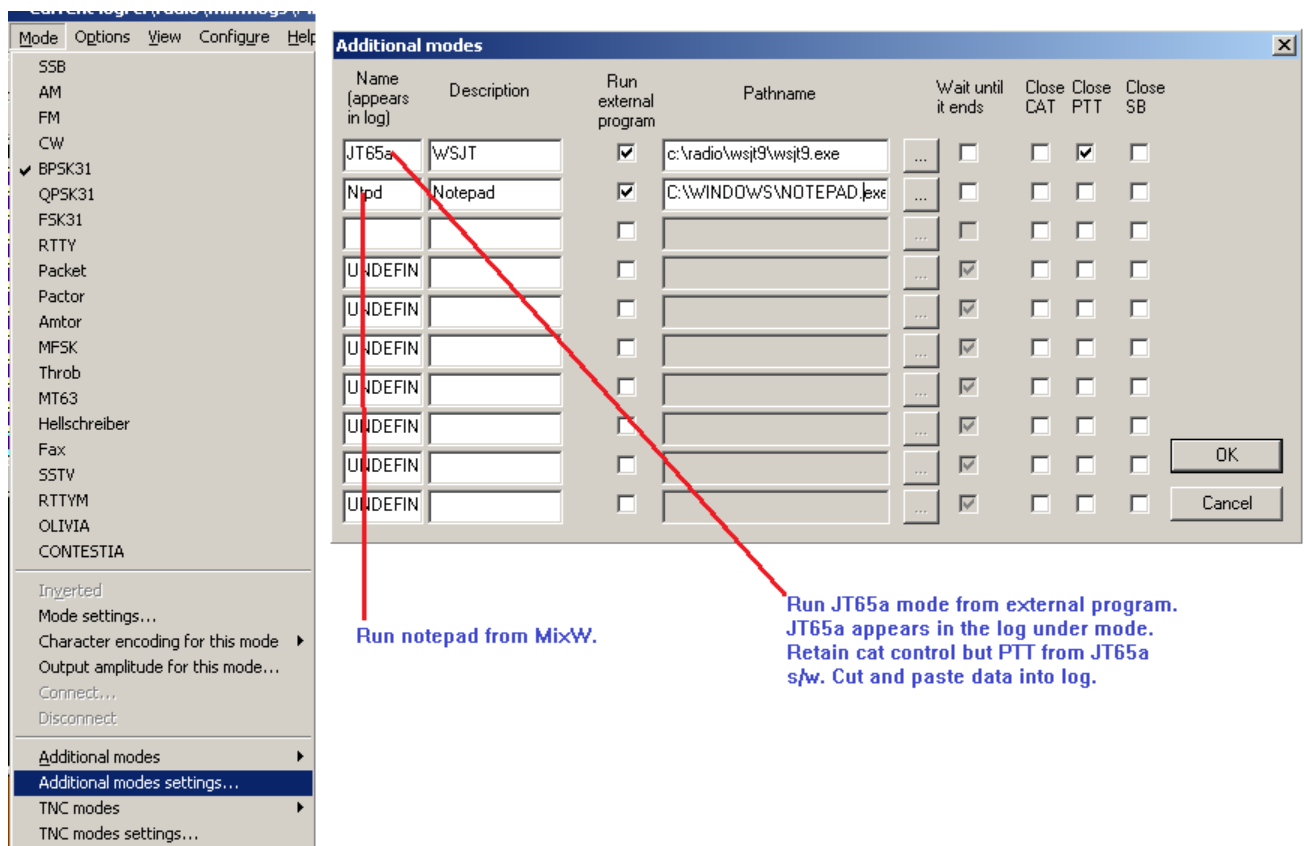

To activate either of these Additional Modes from MixW either use the menu Modes|Additional Modes or use the the macro <MODEADD:additional mode name>. One limitation on using this method of launching a program is there can be no parameter arguments on the pathname.

## MixW Installation

---

A MixW release is delivered as a single self install program (e.g. MixW3\_01b.exe for release MixW3.01b).

Once the program has been checked to make sure it is not [blocked](#) decide where the extracted files are to be installed (either a default or custom installation).

For MixW2.19 and earlier a default installation is not recommended. Microsoft does not encourage writing to the program file folder, which is where MixW installs the data files in these earlier releases. For MixW2.2 and later releases, as the installation progresses the split between program and data files can be seen.

Start the downloaded and unblocked program. An installation window will be displayed, click next which will cause the user licence screen to be displayed, Click I Agree to continue and the component installation screen will be displayed.

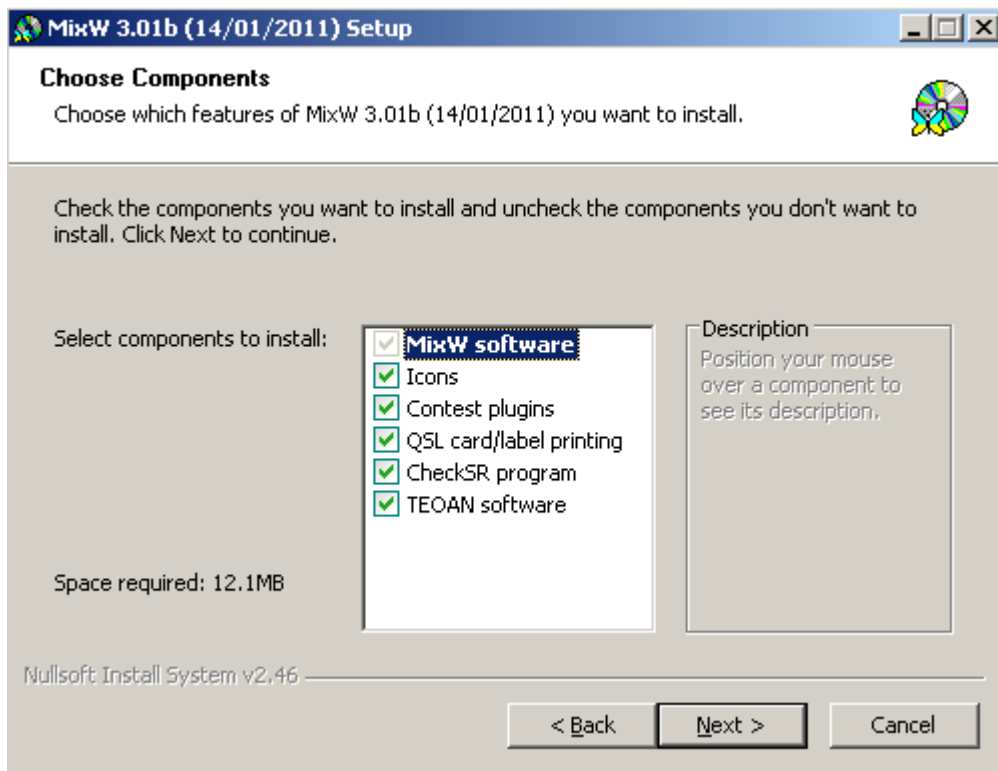

Initially all components are marked for installation. Left click on the checked boxes of any components you don't want to install (if you are unsure hover your mouse pointer over the component to find out what it does) then click Next.

This causes the file installation folder (MixW2.19 or earlier) or the program files installation folder (MixW2.2 or later) selection screen to be displayed.

Either leave the screen unchanged for a default installation or for a custom installation use the Browse button or directly type into the text box to select the required folder.

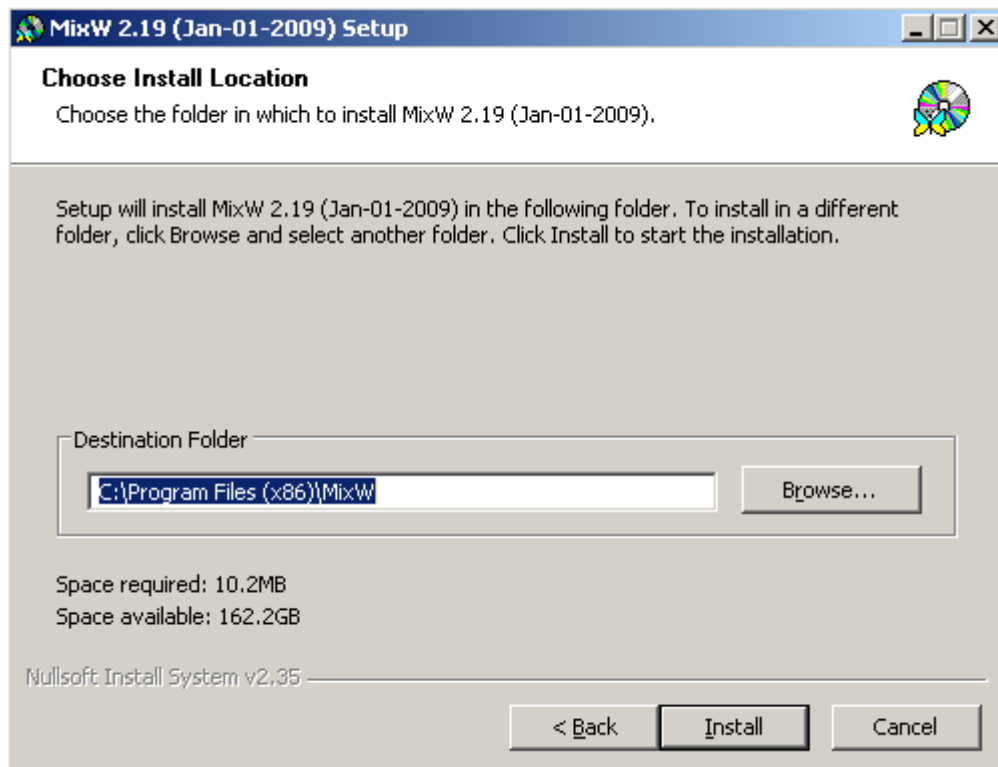

MixW2.19 and earlier file folder selection screen.

If the installation is for MixW2.19 or earlier click on Install.

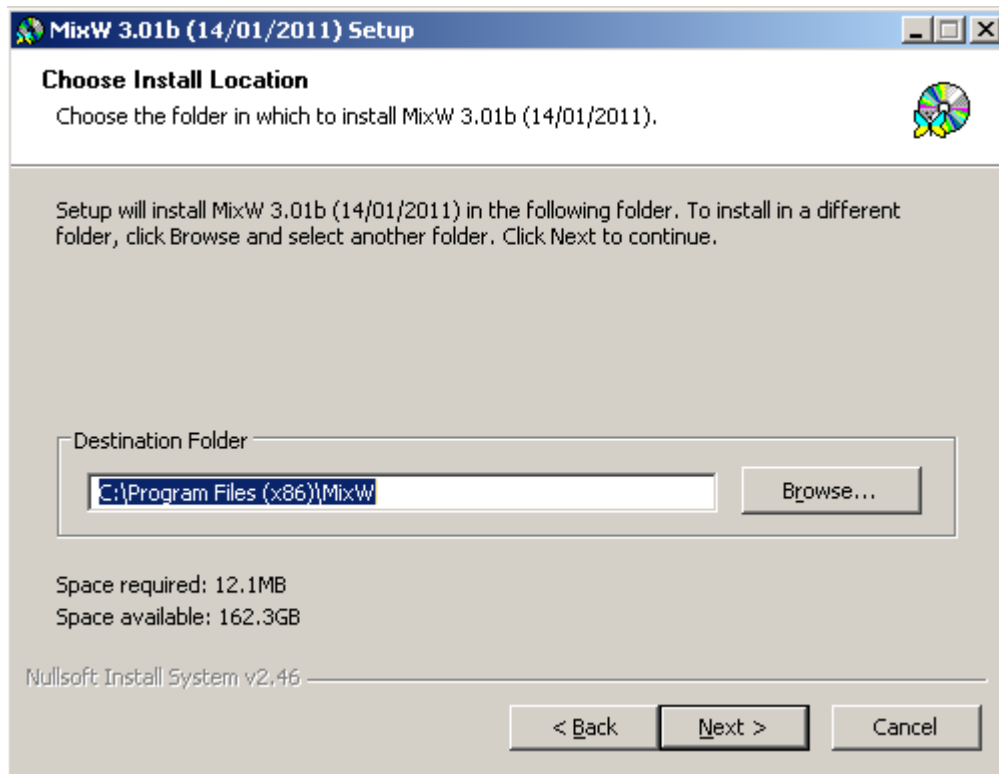

MixW2.2 and later program file folder selection screen.

For MixW2.2 and later clicking on Next will display the data folder selection.

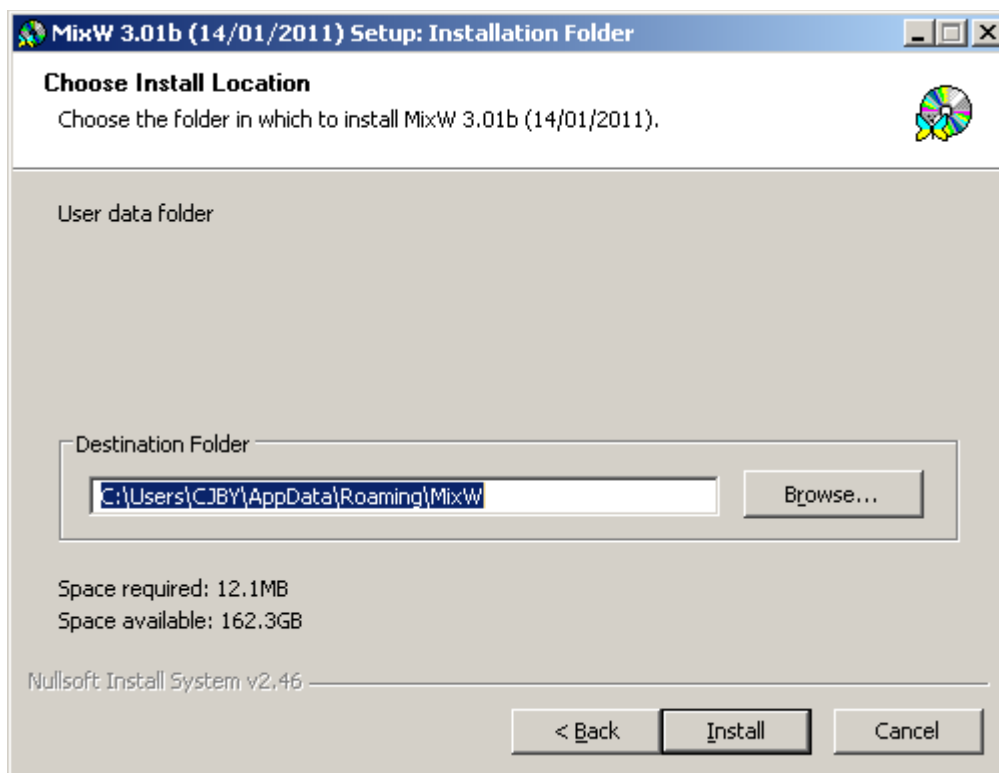

MixW2.2 and later data file folder selection screen.

As for the program files selection leave the screen unchanged for a default installation. Otherwise use the Browse button or directly enter the required folder in the text box. Click on Install.

**Remember the location name entered in the screen above. MixW uses this location to write the latest information files to.**

Once installation is complete it will now be necessary to [configure](#) MixW.

## MixW folder structure on disc

### MixW2.19 and earlier

MixW will create the folder specified in the Choose Install Location screen above (if it does not exist) and then copy all the installation files and sub-folders into this folder.

### MixW2.2 and later

The latest MixW installation is more complex. The program files and data files are installed as two separate parts although the installer can, if they so wish, install most of the files into the program directory. MixW now offers 4 different [log formats](#), CSV, MDB, MYSQL or Web and the program load sequence is changed.

The last two changes to MixW result in a new folder and files being installed although the installer has no control over where the folder is installed. This new folder is a linked folder. A linked folder means it can be addressed from more than one location and any change made to the folder or its contents are reflected to all the locations it is visible in. The new folder is:

c:\programdata\mixw

which is linked to:

c:\documents and settings\All Users\application data\mixw in Windows XP  
c:\Users\All Users\mixw in Windows Vista, 7, 8 and 10

and the new files are:

mixw2launch.cf contains a pointer to the MixW data  
g folder

MixW2.mdb Skeleton MDB log file database

MixW2.sql Skeleton MYSQL log file database

The sub-folders created by the installation process are:

<b>Folder Name</b>	<b>Usage</b>
AutoSavedPictures	Default for saving MFSK/SSTV pictures
Icons	MixW Icon files saved in this folder.
Plugins	Storage for various files used as tools by MixW. Language Files Contest Statistics dlls From MixW2.2 onwards extra mode DLLs
PrintQueue	Record of QSOs to be printed using QSLPrint.exe.

## MixW Load Actions

### NOTE:

During the loading of the latest MixW release the Windows Registry maybe accessed. Considering the danger to the Windows system if an accident should take place no information will be given of what activity takes place. If MixW fails to load the registry is very unlikely to be the problem.

### PLEASE BE CAREFUL. WINDOWS MAYBE UNUSABLE AFTER A MISTAKE

The actions below are listed in chronological load order as observed on one Windows 7 system. There maybe minor differences in activity but it is unlikely these minor differences will inhibit a MixW load.

The first actions taken by MixW after the user has activated a MixW [start up](#) vary between MixW2.19 and earlier and MixW2.2 and later.

During the initial sequence both versions are trying to find the MixW2.ini file. Once this has been found the actions are common between the different releases

There are certain internal Windows security actions that take place before MixW takes control but these are not shown below.

The changes between releases:

#### MixW2.19 and earlier

User activates MixW2.exe MixW identifies the load folder and attempts to read MixW2.ini.

The common path is now entered.

#### MixW2.2 and later

User activates MixW2.exe (V2.2) or MixW3.exe (V3.0/V3.1). The first action is to find the data folder.

MixW looks for and reads mixw2launch.cfg. If mixw2launch.cfg is not found MixW uses the registry to try to find the data folder and finally uses the runtime parameters (if any). MixW attempts to read the MixW2.ini file.

#### Common Path

If MixW2.ini is not found a new MixW2.ini file is created.

Once MixW has first actioned the MixW2.ini file it reads:

- .cwt files - If the eng.cwt file is not found it aborts the start up
- icons.cfg file
- icon files
- lang.ini
- cty.dat - Error flagged if file not found but MixW starts
- pfx.dat - Error flagged if file not found but MixW starts
- calls.dat
- default macro file is read or created.
- MixWContests.ini

bands.ini - Error flagged if file not found. MixW starts but log is not read.  
events.dat  
log file is now read or created  
log bar display initialised  
audio system is initialised  
Plugins folder searched for any required files (Olivia, Contestia, RTTYM dlls, contest stats dlls)  
current mode macros  
KnownFqs.dat  
Not Saved QSO - If last MixW session had an unsaved QSO

Once the MixW installation is complete it is strongly recommended the latest [help files](#) are copied from the MixW reflector.

## Release History

---

This is the Release History of MixW.

### MixW 3.1.1

- RX windows coloring
- Log improvements: sort and optimization

### MixW 3.01

- New World Map with resizing and greyline
- New Telnet dialog with talk and links to QRZ.com and google map
- Backup logs on mixw.net server (password protected)  
Edit Backup.pwd with notepad to set the password

### MixW 2.20

- New LOG database engine with MDB and SQL support  
See personal data, log [...] button  
SQL lets use remote SQL database via internet connection  
more details to follow
- New fast CheckSR (Check samplerate utility)
- Updated QslPrint utility
- Vista/W7 compatibility

### MixW 2.19

- Rx window highlights URLs like http://site.net or mailto:me@server.com and posts according system request on doubleclick
- files Custom1.dat and Custom2.dat contain a list of log fields for the corresponding log layout. Each of these files looks like this:

```
8<--- Custom1.dat -----  
1 MODE  
2 FQRX  
3 FQTX  
4 DATE  
5 TIME  
6 CALL  
7 RSTSNT  
;8 EXCHSNT  
9 RSTRCV
```

;10 EXCHRCV  
14 DOM  
11 NAME  
12 QTH  
;15 COUNTY  
16 IOTA  
17 MGR  
13 NOTES  
;18 ENDDATE  
;19 ENDTIME  
20 LOC  
8<----- end of file -----

Lines which begin with ";" are ignored, so fields EXCHSNT, EXCHRCV, COUNTY, ENDDATE, and ENDTIME are absent in this example. You may change the order of lines (and according columns) but do not change the numbering, i.e. CALL should always have 6 at the beginning.

- The following CAT systems are added:
- Yaesu FT-2000, FT-950, FT-9000D, FT-450, FT-1011
- Kenwood TS-2000, TS-480
- Ten-Tec RX-350, OMNI-VII, ORION-II
- Rotor control added for FT-2000, RC2800, WINROTOR
- Added support for upcoming FSK441m and JT6x modes
- ADIF SRX\_STRING tag is added
- Up to 25 lines in the log bar
- Interface Setup Wizard (See the Configure menu) will help setting up MixW to operate with RigExpert interfaces (Plus, Standard or Tiny models)
- "MixW2 /setup" command line option will also start the Wizard
- New macros:
  - <CATTRANSVERTER:shift\_in\_Hz> - allows working with different transverters
  - <STARTRECORD2> - writes WAVE file from the second input channel
  - <SHOW:RIGEXPERTS> - lists connected RigExpert interfaces
- Hungarian language file is added

MixW 2.18 (18-Feb-2006)

- Spanish translation by Jose Luis (EB2CYQ) added.

MixW 2.18 (09-Jan-2006)

- Kenwood and layout size bugs fixed

MixW 2.18 (30-Dec-2006)

- German language file is added
- Several minor bugs are fixed

MixW 2.18

- Yaesu FT-2000 and FT-9000 supported
- Mouse wheel over macro bar lets you see all 48 macros
- SSTV TX: brightness/contrast fast editing
- Variable number of visible lines for the log bar

MixW 2.17 (01-Nov-2006)

- FT-2000 and FT-9000D support is added
- RigExpert Standard is auto-detected
- Minor bugs fixed

### MixW 2.17 (04-Jun-2006)

- QslPrint program is updated (printer settings are now saved/loaded)
- MixW: CAT under WinXP bug is fixed
- Other minor fixes

### MixW 2.17

- International language support via language plugins.
- Single- and dual-channel MixW versions joined into the single exe file.
- Command-line parameters:  
/1 - run MixW in single-channel mode  
/2 - run MixW in dual-channel mode

### MixW 2.16

- Language extensions, see lang.ini as an example:  
[MASK] and [DXCC] sections define rules of changing the name of a macro depending on a current callsign. For instance, <LANG\_HELLO> will run <RUS\_HELLO> for R\* and U\* callsigns, <DEU\_HELLO> for German callsigns, and so on. If there is no rule, just <HELLO> is executed.
- External mode plugin support (with Olivia as an example: ModeOlivia.dll is available as a separate downloadable file).
- RigExpert Plus interface is automatically set up (if detected). See <http://mixw.net/RigExpertPlus/> for details about RigExpert Plus.
- FSK port and WinKey port settings are now accessible through the Configure menu.
- Extended WinKey setup, see the WinKey.ini file.
- Command-line parameters:  
NODDE - disable DDE function.  
DDE:xxx - set DDE server name to "xxx".  
NOOLE - disable OLE function.  
NONIC - disable TCP/IP over AX.25  
NOREP - disable RigExpert Plus automatic detection.  
MENU1 - use alternative menu.
- Multimedia keyboard support.  
For instance, create the following macro:  
Name: OnAppCommand11  
Label: does not matter  
Text: <FQ:+0.1>  
Then, pressing the Next Track button will increase the transceiver frequency by 0.1 kHz.  
Macro names which correspond to multimedia keys pressed appear in the status bar when MixW is running.
- A separate program to check sound card sample rate is added.  
See "Check sound card sample rate" in Start - Programs - MixW menu.
- New install/uninstall system.
- Several minor bugs fixed.

### MixW 2.15

- DTMF generation macro for SSB/FM/AM modes:  
<DTMF:xxxxx> where xxxxx is what to send
- <SENDSPOT> macro. It works only when Dxcuster Dialog is opened.
- New MixW215s.exe update (a separate download) has two spectrum windows and allows receiving in both of them. Best viewed with FT1000mp :-)
- User defined scrambling is supported for VFH PACKET
- FT980 support is added



- Telnet window script command set is extended by a few commands:
- echo on/off
- autolf on/off
- logging on/onlydx/everything

#### MixW 2.14

- Extended contest support
- CAT support for JRC, FT857, IC7800, IC756PRO3
- MP3 format support (you must have lame\_enc.dll in the MixW folder)  
Use <STARTRECORD:filename.mp3> to start record in the MP3 format (extension must be "mp3")
- ProSisTel rotor support
- WinKey basic support
- Added e-mail field to the Cabrillo output.

#### MixW 2.13 beta 25

- OmniRig support added

#### MixW 2.13 beta 21

- Log bar font and vertical size can be changed

#### MixW 2.13 beta 20

- Telnet window improvements. Try one of scripts to connect the DX cluster. DX Spot Send feature uses telnet window automatically.
- Macro <[> and <]> allow transmitting "<" and ">"
- Receiving sensitivity is improved for some modes
- Controller CBOX 2003 for Pro.Sis.Tel rotators is supported
- "Macros for this contest" item is added in the menu Configure. It is active ONLY in contest mode.
- Frequencies listed in KnownFqs.dat will be shown at the spectrum bar with grey marks, see KnownFqs.dat for the format and add your own if needed.
- "Search and pounce" (SP) and "Run" modes of operation are added. Run mode assumes CQ operation. "Run" is displayed at the caption in Run mode. Three macros are added to switch between Run and SO.  
We can switch between RUN and SEARCH-AND-POUNCE (SP) modes by  
<SP1> (SP on)  
<SP0> (SP off = RUN)  
<SP> (switch between SP and RUN)
- New Macros
- <MILES> is similar to <DIST> but prints miles instead of km
- <TAB> does the same as pressing TAB key
- <TUNE:nn> macro allows limit the transmission to nn seconds
- <ACALL> macro is similar to <CALL>, but allows call changing on the fly.
- <TXE> is similar to <TX> but waits for carrier loss (end of transmission)
- <OnGrabCall> will be called (if defined) when two same calls will be received
- <OnGrabNumber> will be called if serial when number is grabbed into the log
- <STARTRECORD:filename.mp3> will start record a MPEG3 file instead of usual PCM WAVE. The presence of lame\_enc.dll is required in the MixW folder (separate download).
- <CURSOR:N> moves the cursor to the field number N (not column),  
N=5 : Call  
N=9 : Nr Recv  
Known bug: It does not work if the macro button is pressed with mouse, use keyboard instead.
- <CURSOR:TX> moves the cursor to the TX window

- <OnCR> macro tells MixW what to do if CR will be pressed while focus is in the log. It calls <INT> macro by default in contest mode (see below).
- <INT> macro or <INTELLIGENT> does a specific job. It's output depends of the content of CALL and RX EXCHANGE fields.

S/P mode.

Call Rx exchange Output according macro to edit if needed

-empty -empty ? INTQRL

NEWCALL -empty de UT2UZ INTDE

WKDCALL -empty (nothing)

NEWCALL exchange QSL UR 599 001 INTQSL

(and saves the QSO)

RUN mode.

Call Rx exchange Output according macro to edit if needed

-empty -empty CQ TEST DE UT2UZ INTCQ

NEWCALL -empty CALL GA 599 001 INTGA

WKDCALL -empty CALL QSO b4 QRZ INTQB4

NEWCALL exchange QSL 73 QRZ de UT2UZ INTQRZ

(and saves the QSO)

See default macro definitions and change them if needed.

Of course, <INT> macro can be used not only inside OnCR.

MixW 2.12

- PSK31, QPSK31, FSK31:

MMVari codetable is supported (G3PLX table

is extended to Japanese alphabet by Makoto Mori, JE3HHT)

- Spectrum View:

Dynamic range switch is added (80, 60, 40

or 20 db for the visible range of spectrum/waterfall)

- Spectrum View:

FFT window selection is added in the Soundcard settings

(Square, triangle, cosine, Hamming, Nuttall). Square window has the best

frequency resolution, Nuttall has the best sidelobe suppression and

is the best for the IMD measurements. Cosine window is the default and

seems to be a reasonable compromise for usual daily operations.

- RX window:

Tooltip shows the distance and the azimuth to the pointed WW GRID locator

- PSK31:

bandpass filter is improved, seems to work better for close signals.

- RigExpert support:

Input/Output level dialog is added

- CAT:

IC-703 is added to the supported TRCVR table

KENWOOD TS50 lockup at start bug fixed

- New Macros:

<MYWWLOC>, <WWLOC> - local and remote WW GRID locator

- Macro <NAME> returns "my friend" instead of "OM" when the name field is empty.

You may change the value by editing the macro <OM>. Just erase

"my friend" in the text box of Edit Macro dialog if you want

nothing to be transmitted in that case.

- TEOAN:

Remote operation via LAN is supported for RigExpert device.

Soundcard settings dialog is rearranged in order to support

remote operations settings.

For MixW RigExpert users: MixW 2.12 offers an unique feature of connecting a PC with TEOAN program and MixW RigExpert connected to a transceiver into a local area network. Then, running MixW 2.12 on another computer on a network (or via high-speed internet connection) makes possible operating digital modes using that transceiver. In the TEOAN program, set the virtual COM port number for MixW RigExpert and a TCP port number (the default value is OK in most cases). In MixW2, choose "The Eye of a Needle" as an audio device. Enter an IP address or a name of the computer with TEOAN running, and the same TCP port value.

Note: the sound stream is not compressed, so no loss of quality is expected but on the other hand the data rate is high, up to 0.4 MBit/sec (RX or TX) or 0.8 MBit/sec for TX in fullduplex mode. Usual 10MBit LAN is good enough for this application, but slow modem connections will not be able to handle such big stream of data.

- CW:

"@" (AC) symbol is added to the CW table

- Esc behaviour has been changed

. It stops the macro and cleans the TX buffer but does not turn off the TX. Press Esc twice to abort the transmission. If you do not like new behavior then find "OldEsc=0" in the MixW2.ini file and replace "0" with "1".

- Fast INI file reading.

Slow built-in system INI file reading and writing procedures are replaced with optimized ones.

- HTML help support is added. If you prefer old MixW2.HLP file then just remove the file MHH.dll from MixW2 folder (or rename it).

- Band edges are marked with "stop" icon on the frequency scale.

#### MixW 2.11

- 64 kb INI file limit removed (actual for long friends.ini)

- MFSK transmission begins with single tone for easier tuning

- Scanner dialog:

Start button continues scanning instead of restarting.

Right click on the list move the TRCVR to the pointed frequency.

- RX window: local menu (by mouse right click) allows selecting calls with spaces inside, like E A 5 B C

- IC756(pro/pro2): split command bug fixed (IC756 has one command different from other models)

- LOG bar: uppercase characters are entered in the CALL field

- CW settings dialog is changed to support QSK mode

- RigExpert support is improved

- ZelPro rotor support is added

#### MixW 2.10:

- New MixW2.exe command-line parameters:

NODDE - disables DDE feature

DDE:xxx - sets DDE service name to xxx

NOOLE - disables OLE feature

NONIC - disables the use of virtual network adapter

- AFSK in place of FSK option added to PTT/CAT dialog to explicitly set whether we want to use AFSK in RTTY mode (checked by default)

- User-configurable multi-language support added to CW module.

See the \*.cwt files in MixW directory (unicode files, should be open with notepad.exe).

- New CW macros:

<LANGUAGE:xxx> - select a language

where xxx=

- ENG - English
- RUS - Russian
- FRA - French
- SWE - Swedish
- SPA - Spanish
- GER - German
- ESP - Esperanto
- JAP - Japanese

<FORCELANGUAGE:xxx> - for languages where CW codes are shared with English alphabet (for instance, Russian and Japanese).

This macro forces characters to be received as xxx.

- Added support for Ten-Tec Argo, Orion, RX-350, YAESU FT-897 and FT-1000mp with different firmware

- Added support for RigExpert

- New macros:

<AZ> - Azimuth

<DIST> - Distance in km

<WKDPERIOD:nnn> : nnn = period in minutes. QSO before is ignored if more than nnn minutes elapsed.

<WKDIGNOREBEFORE:date time>: QSO before is ignored before specified time.

<PTTON>, <PTTOFF>, <PTTSWITCH> : switch the TRCVR PTT

<PRINTQSL> : put the selected QSO line into the QSL Print Queue

<FROMCLIP> : get the picture from the clipboard (SSTV mode)

- We can explicitly set a DXCC country for the callsign in any QSO to fix the problem with several possible DXCC entries for the same callsign.

See the Edit QSO dialog.

MixW 2.09:

- PSK63 is supported for the Export operation

- CAT for FT1000MP is improved

- a couple of minor bugs fixed (in CW RX module and CAT system)

- collection of icons by K6MKF is added

MixW 2.08:

- Notch filter is added, accessible via Spectrum window local menu (right click on the waterfall). Be sure, this feature requires faster CPU

- one more AX25 modem (4800 baud) is added.

- Alternate LPT interface has been added

- Icons will be drawn in the RX window after some known words. See Icons.cfg.

- PSK63 mode support via <BAUDRATE:62.5> macro.

- <CURSOR:n> macro places the input focus to the specified column number of the log bar, useful for contests. Example:

<TX><CALL> de <MYCALL> <GA> ur <RSTS><NRS><RX><CURSOR:9>

MixW 2.07:

- SSTV Drag'nDrop

- Q15AX25 support. Note: Q15X25dll.dll is not included to the distribution due to licensing limitation. Download and install the dll separately.

- Resizing history bitmaps.

- MT63 manual tuning & secondary channel.

- MACRO <MARKERS:xx,yy,zz,tt,ww>.

- Auto-created macros like <WX?>.

- One level recursion like <CATCMD:PO<POWER>>.
- Friends file support <INIFILE,HI,?C>.
- Telnet echo on/off toggle.
- MT63 secondary RX, manual tuning.
- Set markers macro <MARKERS:1000,1020> (up to five frequencies).
- Transmitting pictures in MFSK16 mode.
- International characters transmission support, including Japanese hieroglyphs. See menu Mode - Character encoding, UTF8, JIS etc.
- QslPrint executable allows printing a huge amount of QSLs and labels.
- Cabrillo support for BARTG Sprint and BARTG Spring (AKA BARTG-RTTY).
- Macro <IMD>, works if IMD is fixed on the statusbar

#### MixW 2.06:

- Control bar (Macro bar):
- resizing horizontally and vertically
- background color can be changed for each button, see button "A" after "Label" in Edit macro dialog.
- DxCluster dialog rearranged, button "Back" is added, it jumps to previous frequency (if any).
- Ten-Tec Jupiter support (requires new "Enhanced PC Control" firmware)
- Added ability to use macros in packet beacon text.

Example:

Beacon de UU9JDR, local time=<LOCALTIME:%H:%M:%S>

#### MixW 2.05:

- YAPP file transfer support for PACKET mode.
- Crash recovery is supported.
- See File - Yapp menu:
- "Auto receive" turns on the feature when MixW automatically opens YAPP Receive window when remote station starts sending a file.
- "Crash recovery" turns on YAPP protocol extension to be able to resume partially received files.
- LPT port support for paddle input and PTT/CW output (TRLog-compatible). See Configure - LPT port settings. Go to CW settings dialog to turn on the LPT paddle.
- Telnet window is implemented to access DxClusters via telnet See View - Telnet window menu. See "EA7URC\_DXC.scr" as an example how to automatically login to a node. To automatically run this script when Telnet window opens, define OnOpenTelnetWindow macro as follows:
  - Macro: OnOpenTelnetWindow
  - Label: - doesn't matter -
  - Text: <TELNETSCRIPT:EA7URC\_DXC.scr>
- optional "Check QSL" flag is added to the DxCluster dialog. (see system menu in that dialog)
- PACTOR-1 LP mode is added, RX only :-(
- DxCluster dialog:
- WWV page can be called.
- Modified Settings dialog.
- Font selection is added.

- Column widths are remembered.
- Memory dialog is added to watch Ctrl+1..10, Sh+Ctrl+1..10 channels.  
See menu Options.
- SSTV FSKID is added, compatible with MMSSTV, turned on by default, recommended, can be turned off in SSTV mode settings.
- Search result dialog:
  - column widths are remembered.
  - Font selection is added (see menu under butterfly).
  - Esc returns to the previous dialog.
  - Set QSL Rcvd, Set QSL Sent added to the local menu. That allows input multiple QSLs at a time.
- Log bar:
  - resize: doubleclick on the edge of logbar, resize, doubleclick again.
  - QSO column shows QSO number
- New macros:
  - OnOpenTncWindow, OnCloseTncWindow, OnOpenTelnetWindow, OnCloseTelnetWindow, use these macros to run specified commands when TNC or Telnet window opens or closes.
  - <CLOSERXWINDOWS> closes all opened secondary RX windows
  - <YAPPRECV>, <YAPSEND>, <YAPSEND:filename> - YAPP support
  - <MYMAINCALL> returns callsign stripped from "/P"/"QRP" etc
  - SSTV specific macros:
    - <LOCKMODE>, <UNLOCKMODE> - lock/unlock current SSTV mode
    - <PUTRXPIC:x0:y0:x1:y1> - put received picture into the specified rect
    - <PLACETEXT:x:y>, <PLACETEXT:x:y:text> - place text to specified x,y
    - <TEXTSTYLE:n> - set current text style
    - <TNCSCRIPT:filename>, <TELNETSCRIPT:filename> - run script file in 2nd TNC or Telnet window.

#### MixW 2.04:

- IC746pro is added to the list of directly supported TRCVRs.
- RTTY: ASCII7 and ASCII8 modes are added, high speed limit is now 1800 baud for two filters demodulator and more than 2400 for single filter.
- SSTV: MP115 mode is added
- SSTV: New text styles are added: outline with and without fill, gradient fill, diagonal cross fill. Use Shift+Font Color and Ctrl+Font Color (Red "A") to change outline and second gradient color accordingly.
- Advanced Waterfall option is added (see menu View > Spectrum)  
It moves waterfall along with frequency. CAT must be installed to use this feature.
- Spectrum/Waterfall speed may be increased up to x16.  
This will not work on slow computers. Reducing the RX buffer size to 128 is recommended (m\_iBufRxSize=128 in MixW2.ini).

- Packet:
- KISS TNC emulation. This allows usage MixW2 packet module with other packet software. Tested with UI-View.
- UI frames are sent in "NOT CONNECTED" state. Beacon address is used.
- New macros: <NEWRXWINDOW:audiofq> create New Rx Window on specified audio frequency
- <NEWRXWINDOW:audiofq:mode> same as above with specified mode
- <CWID:text> set "text" as CW ID. Useful in <OnStartMode>.
- <CWID:DEFAULT> set default CWID (as described in personal data dialog).
- Added some icons to the DxcDialog dialog
- ;

#### MixW 2.03:

- Hellsreiber: FM mode is added (see mode settings).
- Mouse wheel support to tune the TRCVR. See PTT/CAT settings dialog.
- Scanner dialog (menu View > Scanner). Very useful for checking condx on dead bands like 10m, 6m, VHF, and UHF.
- New Macro:
  - <ALERT:text> - Brings up a Messagebox with "text".
  - <BEEP:xx>, xx = On or Off. Switches beeper.
  - <OnEnterNNN>, <OnLeaveNNN>, NNN = 160m, 80m etc. Macro to execute nn band change. Define such macros if you need to do extra work on band change (like run external program to switch relays or send specific CAT command to the TRCVR)
- Friendly "No Soundcard" message
- Manual entry mode now sorts log entries. See menu View->Log bar->Manual Entry Mode
- Log scanning procedure improved (takes less time).
- "Merge from" button is added to the Edit Macro dialog. This feature is useful to add transceiver-specific macros. For example, CatKenwoodTS450.mc may contain several macros:

Name: AIPON  
 Label: AIP on  
 Text: <CATCMD:MX1;>

Name: AIPOFF  
 Label: AIP off  
 Text: <CATCMD:MX0;>

and so on.

Then I can use <AIPON> and <AIPOFF> to control the transceiver like if they were built-in macros.

- VHF 2400/4800 packet is reanimated.

- Some Brazilian prefixes are added
- IC910H, IC718, FT1000m are added to the list of directly supported TRCVRs.
- SSTV: CWID is supported now

#### MixW 2.02:

- IARU beacons dialog added (menu View > NCDXF/IARU Beacons)  
Be sure your computer time is set correctly, high accuracy (+-1 second) is desired. Use wellknown freeware utilities like NetDate to be in sync with the whole world automatically. GPS or any other precise clock source may be used as well. Click onto desired frequency to move the TRCVR there. Previous Fq and mode will be restored after closing the dialog.
- TCP/IP connection via PACKET, as an alternative to SV2AGW PACKET ENGINE and FLEXNET. Requires additional network driver (download from <http://tav.kiev.ua/~nick/TcpIp.html>)
- PACKET settings dialog:
  - General tab:
    - Separate callsign box for TCP/IP operation
  - Parameters tab:
    - 9600 baud (G3RUH-compatible) bit shapes (select one of 16)
  - Beacon/monitor tab:
    - Show content of IP/ARP packets
    - Baudrate measurement (show baudrate of "I" packets)
- The TRCVR/CAT dialog has an option "Show zero beat frequency" this affects CAT bar only, LOG shows real FQ as was before.
- Export: DxccPfx is added
- Statistics: SSTV is no longer DIGITAL
- 2nd RX window size is saved
- Word mode added (menu View). To turn on or off this mode use new macros <WORDMODE:ON> or <WORDMODE:OFF>
- Capitals Only mode added. Use according macros <CAPITALSONLY:ON> or <CAPITALSONLY:OFF> to switch the mode.
- <MEMW:n> and <MEMR:n> macros are equivalent to Ctrl+n and Alt+n and can be used to save and restore current frequency and mode.
- some fixes for YAESU CAT control
- Elecraft K2 Support added
- Callbook datapath adviser (for those who do not want to read FAQ or HELP)
- CWID amplitude bug fixed (now it follows current mode setting)



- SSTV:
- B/W 8s and 12s (160x120), 24s, 36 and 43s (320x256) B/W modes added
- WWV mode can be used to calibrate the soundcard while receiving WWV signals. Time marks are transmitted on 4996, 9996, 14996 KHz. Tune TRCVR to 4994.100, 9994.100, 14994.100 (USB) accordingly since audio center is usually at 1900 Hz.
- Be patient if you do not hear anything. Time marks aren't transmitted all the time, up to 5 min. pauses are expected.
- SSTV slant correction can be moved to soundcard samplerate correction, to let other modes use that correction as well. See button "Go" in SSTV mode settings dialog.
- Tuning indicator improved
- Zoom window now is non-modal, so it can be placed anywhere to see what's being received while preparing the TX picture.
- Up to 16 history bitmaps can be shown now (smaller size, of course)

MixW 2.01:

- New macros:  
<INIFILE:file,section,name> - insert a line from an ini-file.

Suppose I have a program that measures the temperature using a sensor outside of the house and periodically writes the value into d:\temp\sensor.ini file:

```

--- start of d:\temp\sensor.ini ---
[Sensor]
Temperature=xx
Humidity=yy
Illumination=zz
--- end of d:\temp\sensor.ini ---

```

Then I can make a macro:

The current temperature in Kiev is  
<INIFILE:d:\temp\sensor.ini,Sensor,Temperature> degrees centigrade.

- Export to CSV format: See the Search Results dialog.
- Export to text format: Text format has been changed.
- PTT / CAT dialog: "DIG" drop-down box sets DIG mode (for YAESUs only) to use LSB, USB, or FM.
- Search dialog: Added "QSL sent" and "QSL received" search options. Print support is added.
- CW: Proper receiving of own CW while keying with Joystick or Mouse.
- Install: Icons are created on the desktop and Start Menu. Known bug: Icon creation may not work on old W95 with old version of Internet Explorer (or without it at all). Just ignore the error and create Icons manually if needed.
- Bugs: SSTV dialog remembers the last position

**QSLPrint.exe**

---

## QSLPRINT.EXE

This program is installed as part of the MixW installation. The program is installed in the program files folder. The latest version is 1.08, delivered with MixW2.2 and later, QSLPRINT.exe V1.07 was delivered with MixW2.19.

This program is designed to print QSL cards designed by the user, or to print labels. The data is obtained from a Print Queue set up by the user using MixW or for QSLPRINT.exe V1.08 only directly from a selected QSO in the MixW Log Bar.

Once loaded there is an example QSL card that can be loaded to demonstrate the program capabilities.

## Print Queue

The print queue is set up as a folder PRINTQUEUE within the MixW Data Folder.

Each file within the print queue contains the QSO data line extracted from the MixW log. The file name has the format PR-Callsign.qpq where PR is the country prefix for the country the callsign comes from. So for example the call CG3ZZZ is from Canada so the file name would be VE-CG3ZZZ.qpq.

The print queue may be set up in one of three ways. Either:

Select the QSO to be added to the print queue in the log bar and press Ctrl-Shift-P key combination

Select the QSO to be added to the print queue in the log bar and select File->Add QSO to print queue

Display the log using the hourglass icon bottom left of the log bar, select the QSO(s) to be printed, right click and select Print QSL.

The program QSLPRINT.exe does not need to be running to set up the print queue.

Once the QSO data has been copied to the print queue a message box will be displayed indicating the fact (different message box depending on which method you used to put the data in the print queue).

Once the QSO data is in the print queue folder the QSL sent field in the log will be set.

**Note:** If the callsign for a selected QSO already has an entry in the print queue the data will be merged with the existing entry. Although any number of QSO records may be merged into a single entry the program will only select and print the first two entries on a label or first 3 entries for a QSL card.

## Formatting and Printing the Media

Start QSLPRINT.exe. There are no command line parameters.

First make your personal selections in the File, Edit and View menus. This information will be saved in a file QSLPRINT.ini, found in the MixW data directory.

Now select your media and if you are using QSL or Labels set up the dimensions for your selected media. At this point save the set up in a new file name. By default QSLPRINT.exe will save the

data in the MixW data folder using a suffix of .qsl.

Now use the New menu to insert new objects on to the media. Each item you create is a separate object. These objects maybe dragged into position using standard windows methods.

If you are creating text double click on the row of 5 Xs to bring up the edit text box, change the Xs to your desired text and use the Font button to change the font to the desired size and characteristics (including colour).

The text can include field names to incorporate unique data from entries in the print queue or from the selected MixW log bar QSO. The usable field names are listed below. Beware a couple of spelling anomalies.

If the media is being created with a capability to print multiple QSO acknowledgements on the same media then the field names should have the figure 1 appended to the name (e.g. <MODE> and <MODE1>) to select the second set of data and 2 to select the third set of data.

When each object is created it has an attribute Enable Print Object assigned to it. The attribute must be set to enable the object to be printed. To remove an object from the printed output but retain it on the media select the object and select the Edit menu->Enable Print Object. Once this is unchecked the object will not be printed until the menu item is re-enabled.

Now go to the Edit->QSL Data and select Load from Queue or (if available) Use DDE.

The media will now be populated.

**Note:** Although a print queue entry can contain an infinite number of entries only the first three sets of data will be printed on a QSL card and two sets of data will be printed on a label, although multiple labels will be created until all the entries in a print queue record have been produced.

## Fields available

<BAND> - Print Band

<CALL> - Print Call

<COUNTRY> - Print County \*\*\*Spelling?\*\*\*

<DATE> - Print Start QSO Date

<DATETIME> - Print Start QSO Date & Time

<DOMAIN> - Print Domain

<EDATE> - Print End QSO Date

<EDATETIME> - Print End QSO Date and Time

<EDAY> - Print End QSO Day

<EMONTH> - Print End QSO Month

<ETIME> - Print End QSO Time

<EXCHRCV> - Print Exchange Received

<EXCHSHT> - Print Exchange Sent \*\*\*Spelling?\*\*\*

<EXCHSNT> - Print Exchange Sent

<EYEAR> - Print End QSO Year

<IOTA> - Print IOTA

<KHZ:n> - Print QSO Frequency in KHZ to n decimal places

<MANAGER> - Print Manager

<MHZ:n> - Print QSO Frequency in MHZ to n decimal places

<MODE> - Print Mode

<MONTH> - Print Start QSO Month

<MYCALL> - Print My Call

<NAME> - Print Name

<NOTES> - Print Notes  
<QSLINFO> - Print QSL Message  
<RSTR> - Print RST Received  
<RSTS> - Print RST Sent  
<TIME> - Print Start QSO Time  
<VIAMANAGER> - Print via Manager  
<YEAR> - Print Start QSO Year

**To properly use this program and its facilities you need to experiment.**

## Script Commands

---

Script commands are written one per line. A line beginning with a semicolon is considered a comment. Invalid commands are skipped. The following information is taken from Nick's website.

**The following Script commands are available in MixW:**

send "string to send"

- String may include control characters, for example, "^C"

timeout n

- The following waitfor commands will timeout in n seconds

waitfor "string to wait for"

- Wait for this string before continuing (^C, etc. allowed)

sleep n

- Sleep n seconds

Pause

- Pause and wait for operator to press "Continue" button

Close

- End the script and close the script window

runmacro "macroname"

- Run this macro (example: runmacro "FQ:14071")

sendmacro "macroname"

- Insert macro as text (example: sendmacro "MYCALL")

---

### Macros used with scripts

<SCRIPT:filename>

- Run script from a file

<ASSCRIPT>

- Treat the rest of this macro as script

<TNCSCRIPT:filename>

- Run script on the second TNC

<TELNETSCRIPT>

- Run script file in Telnet window

## TEOAN

by Denis Nechitailov, UU9JDR

A soundcard/CAT interface device called RigExpert1 or RigExpert S/D was introduced specifically for use with MixW. This interface is now discontinued and has been replaced by a number of general purpose sound/cat interfaces.

TEOAN will only work with RigExpert S/D and RigExpert1 devices.

MixW 2.12 and later versions offer an unique feature of connecting a PC with TEOAN program and MixW RigExpert plugged to a transceiver into a local area network.

Then, running MixW 2.12 on another computer on a network (or via high-speed internet connection) makes possible operating digital modes using that remote transceiver.

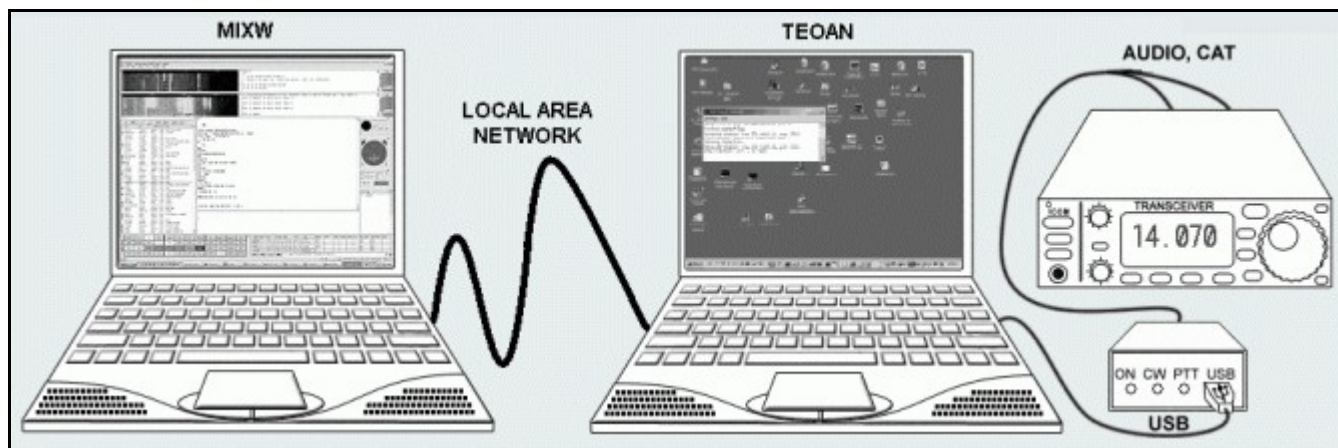

*Left side: computer (network name: **dn-acer**) running MixW software  
Right side: computer (network name: **dn-compaq**) with MixW RigExpert connected.*

In the TEOAN program, set the virtual COM port number for MixW RigExpert and a TCP port number (the default value is OK in most cases).

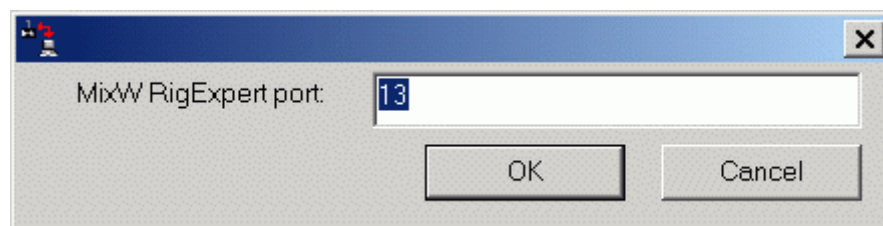

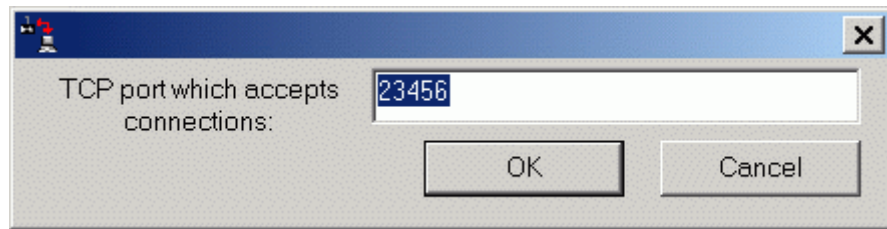

*TEOAN settings at **dn-compaq** computer.*

In MixW2, choose "The Eye of a Needle" as an audio device. Enter an IP address or a name of the computer with TEOAN running, and the same TCP port value.

*Please make sure that the CAT port speed is set properly. See the TRCVR CAT/PTT dialog from Configure menu.*

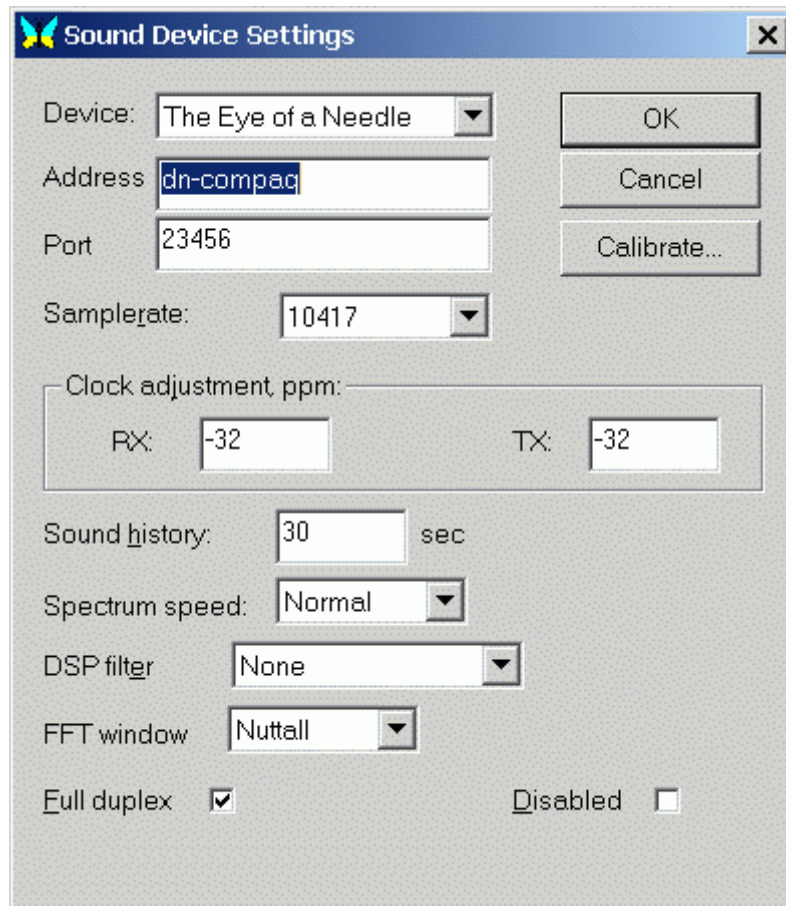

*MixW sound device settings at **dn-acer** computer.*

Note: the sound stream is not compressed, so no loss of quality is expected but on the other hand the data rate is high, up to 0.4 Mbit/sec (RX or TX) or 0.8 Mbit/sec for TX in full duplex mode. Usual 10 Mbit LAN is good enough for this application, but slow modem connections will not be able to handle such a big stream of data.

The TEOAN program is located in the MixW directory. Copy TEOAN.EXE from the computer with MixW installed to the other computer (create a separate directory).

## **TNC Config & Operation**

---

## With thanks to RICHARD B. GRIFFIN, NB6Z

TNC operation is accomplished in MixW by providing a communications link (using a serial port) between the PC running MixW and the TNC. The PC will act as a "terminal" to send commands to the TNC and display characters sent from the TNC. In this configuration the TNC will be operated in the "command" mode and not in the "host" mode, as would be done if a "host" program like XPWin or KaGold were being used. In command mode appropriate commands are used to correspond with the model of TNC being used. The command structure for your TNC should be available in the Operator's Manual provided from the TNC manufacturer.

To configure MixW for TNC operation, first select Configuration | TNC Settings, which brings up the following dialog:

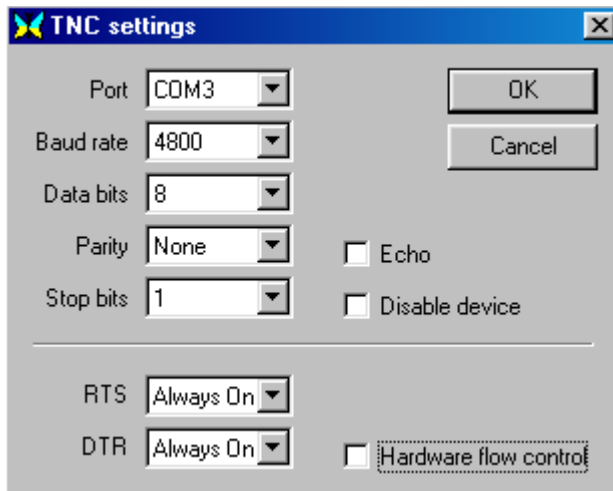

The screenshot shows the 'TNC settings' dialog box. It features a title bar with a close button. The main area contains several configuration options: 'Port' is set to 'COM3', 'Baud rate' is '4800', 'Data bits' is '8', 'Parity' is 'None', and 'Stop bits' is '1'. There are two checkboxes: 'Echo' and 'Disable device', both of which are unchecked. Below these are 'RTS' and 'DTR' dropdown menus, both set to 'Always On'. At the bottom right, there is a 'Hardware flow control' checkbox, which is also unchecked. 'OK' and 'Cancel' buttons are located on the right side of the dialog.

Set these parameters to the same values that you were previously using with your TNC or refer to the TNC Operator's Manual for the com-port setup information. You have the option to "echo" all commands back to the MixW screen. Normally you will leave ECHO unchecked.

Next, select Mode | TNC mode settings, which will bring up the following dialog:

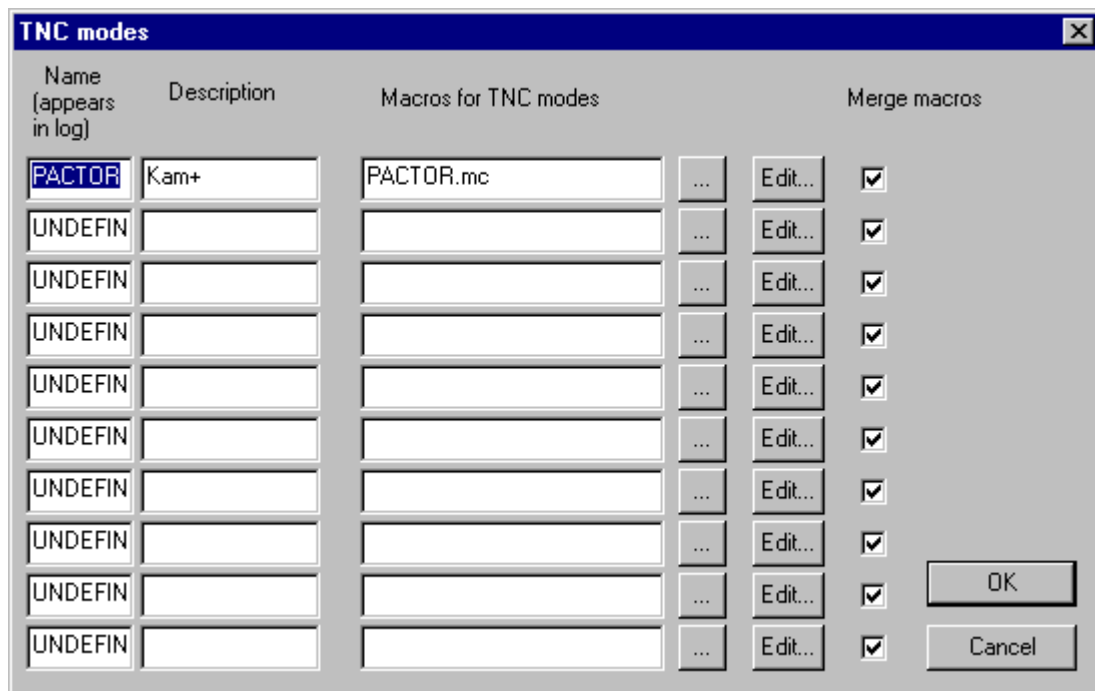

The screenshot shows the 'TNC modes' dialog box. It has a title bar with a close button. The main area is a table with four columns: 'Name (appears in log)', 'Description', 'Macros for TNC modes', and 'Merge macros'. The first row has 'PACTOR' in the Name column, 'Kam+' in the Description column, and 'PACTOR.mc' in the Macros column. The rest of the rows have 'UNDEFIN' in the Name column. To the right of the Macros column, there are three columns: an ellipsis button, an 'Edit...' button, and a checked checkbox. At the bottom right, there are 'OK' and 'Cancel' buttons.

Name (appears in log)	Description	Macros for TNC modes		Edit...	Merge macros
PACTOR	Kam+	PACTOR.mc	...	Edit...	<input checked="" type="checkbox"/>
UNDEFIN			...	Edit...	<input checked="" type="checkbox"/>
UNDEFIN			...	Edit...	<input checked="" type="checkbox"/>
UNDEFIN			...	Edit...	<input checked="" type="checkbox"/>
UNDEFIN			...	Edit...	<input checked="" type="checkbox"/>
UNDEFIN			...	Edit...	<input checked="" type="checkbox"/>
UNDEFIN			...	Edit...	<input checked="" type="checkbox"/>
UNDEFIN			...	Edit...	<input checked="" type="checkbox"/>
UNDEFIN			...	Edit...	<input checked="" type="checkbox"/>
UNDEFIN			...	Edit...	<input checked="" type="checkbox"/>

On the first UNDEFINED line in the list replace the word UNDEFINED with the name of the TNC mode as you want it to be shown in the log. In the Description column enter information to further identify the mode. Then in the "Macros for TNC modes" column enter the file name

(ending in .mc) that you will use to save the macros for this mode. The button with the (...) may also be used to browse for a file on your disk if you have imported a file or made a previous file. Then click OK.

Now you can start a TNC session by selecting Mode | TNC modes | <the mode from your TNC modes>

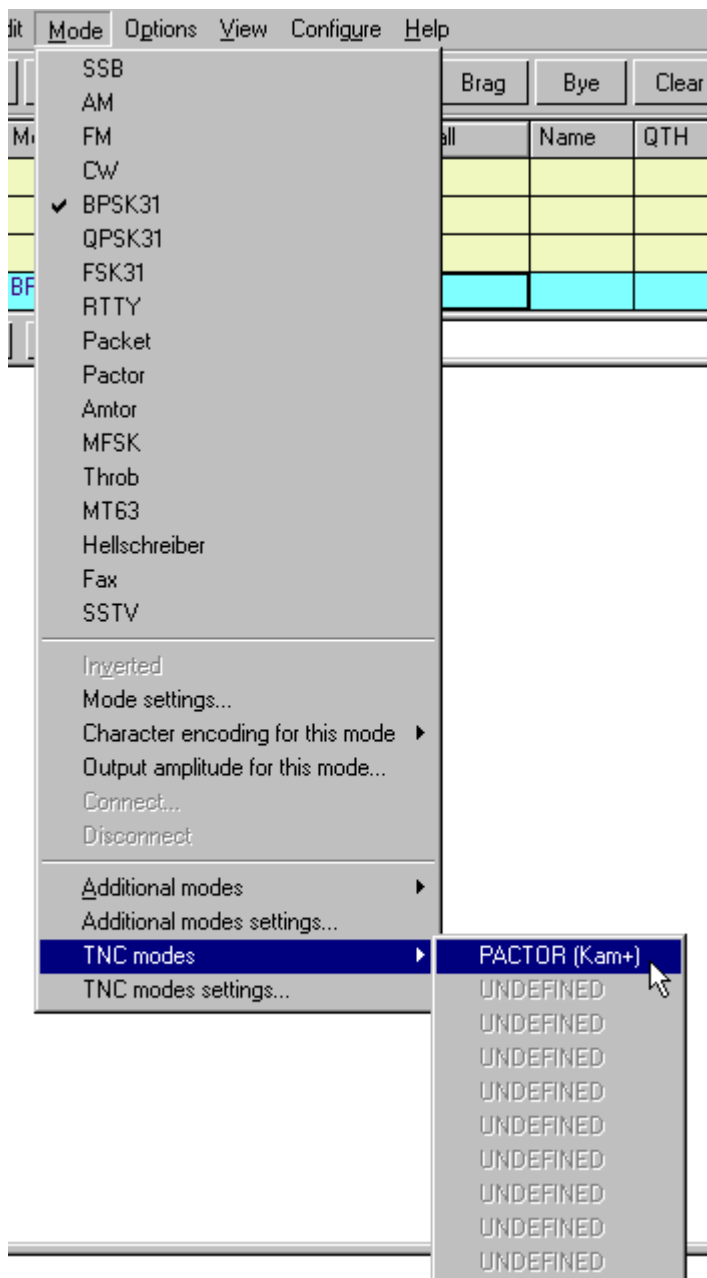

If you have Configure | Merge macros checked, your default macros will still show up on the macro buttons, but you can now define or redefine your macro buttons specifically for the TNC mode you are in.

As a very simple example, you can create a macro button to start the TNC "command" mode (<CTRL-C>X for the KAM) and then type commands directly into the TX window and execute them by hitting the ENTER key. To do this, first right click on the button you want to use. If you right click on F4, for example, you will see this dialog:



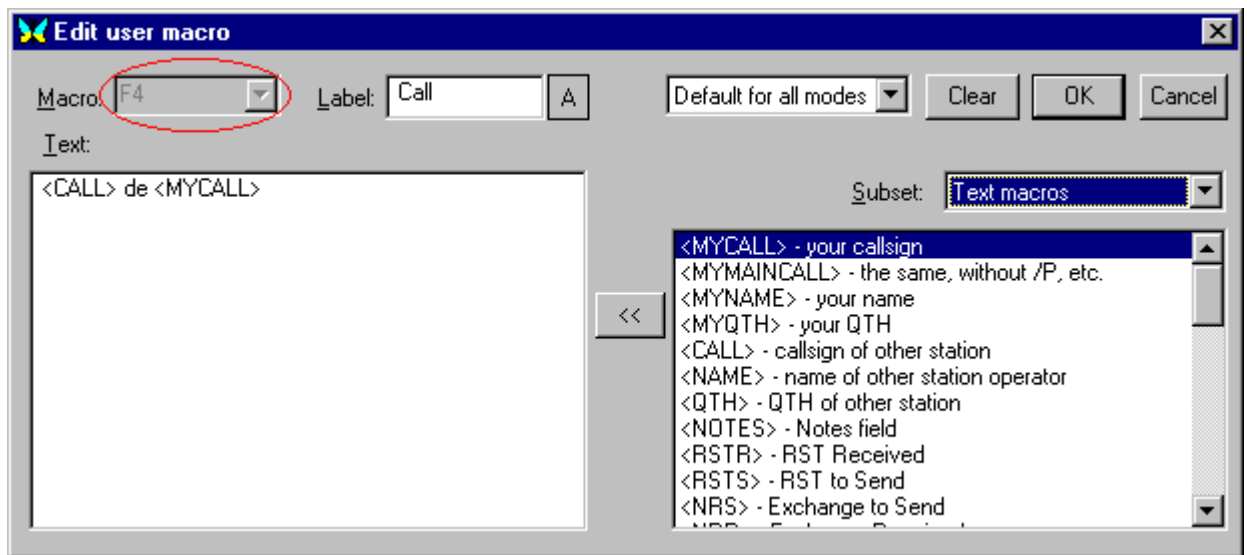

You can convert this macro to be used to initialize the TNC by changing the label to "TNC Start", changing "Default for all modes" to "For this mode", and replacing the contents of the Text window with: <CTRL-C>X. Click on the OK button when finished. Now you can click on your "TNC Start" macro button to put the Kam into command mode and then begin to type TNC commands directly into the TX window.

When you want to leave the TNC mode select Mode | <any other mode> and the F4 button will revert to its previous state.

Obviously you would not want to operate your TNC this way for very long, so now you can continue to redefine other macro buttons for the various TNC functions and actions you want to use.

Two very important macro commands for configuring your TNC are OnStartMode and OnEndMode which will allow you to automatically initialize the TNC when the TNC mode is selected and leave the TNC in the appropriate state when you leave the TNC mode. Event macros such as OnStartMode can not be edited with the right click method outlined above, since they do not show on a button. To add event macros to a macro file select Configure | Macros for this mode, browse for the file you want to modify, and then click on the Edit button.

A sample macro file for the KAM TNC called pactor-kam.mc is provided with the MixW program. You may use this file to operate Pactor mode on a KAM TNC and duplicate/modify it for other KAM TNC modes like G-tor and Amtor. If you have another manufacturer's TNC, you should use this file as a template to create macro files with the commands specified by your TNC manufacturer.

## Voice Keying

By Jim Jaffe, WA2VOS

One of the best things in MixW is its' ability to use WAV files in the SSB Mode for Voice Keying. I've made up a few Macros which I use constantly to call CQ thus saving my voice when the band appears to be Dead! I have a macro for each band starting with 10 and ending with 75 meters.

In order to use the WAV file you need to be in SSB mode! Go to the Modes Menu and Select SSB. You can make as many Macros as you wish following this format:

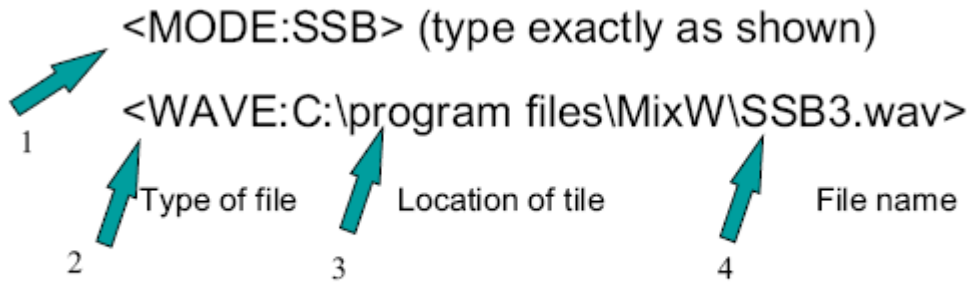

(Fig. 1 Mode, Fig. 2 Type of File, Fig. 3 file Location, Fig. 4 File Name)

You can transmit in any mode you like ie; AM LSB USB FM using your Rig's mode control or if you're running CAT mode click the Mode from USB to any other you prefer..most common would be USB/LSB as most of us use Single Sideband modes.

A very quick and easy way to create a WAV file: The following are 3 macros each one is separate and apart from the other.

<STARTRECORD:echo.wav> - Start recording into the specified file

<STOPRECORD> - Stop the above record

<WAVE:echo.wav> - Play it now

All voice keying files are titled SSB#.wav

Second Method for Creating WAV files: To create the file click Start, go to ALL Programs /Accessories/Entertainment select Sound Recorder. You get 60 seconds of recording. Save file as SSB#.wav. Try the default settings of the Sound Recorder and test with your rig using a Dummy load.

## **DXAtlas**

---

**By Finn Helmuth Pedersen, OZ6LI**

You will need to make a few preparations in order for MixW and DxAtlas to work together :

Go to the MixW site to get the latest MixW version, and then DxAtlas.

Now follow this sequence:

1) After downloading the files, install in the usual/suggested MixW and DXAtlas directories.

2) Download the Visual Basic source code and Exe file:

[www.mixw.net/files/Mix2DxAtlas1.zip](http://www.mixw.net/files/Mix2DxAtlas1.zip)

After download unpack the file into your MixW directory.

3) Third step is to create a Macro within MixW:

Load MixW and create a new Macro, e.g. with the name of "ATLAS".

This macro will need the following content:

<EXEC:C:\Programmer\DX Atlas\DXAtlas.exe>

<EXEC:C:\Programmer\MixW\Mix2DxAtlas.exe>

Of course the path names will depend of your actual paths.

The first line is to initially activate the DxAtlas program from within MixW. The second line awakes the DDE data transfer program Mix2DxAtlas.

Now you are ready to utilize the benefits of the great Digital program (MixW2) in "tandem" with the great DX Atlas program.

- 1) Load MixW as usual.
- 2) Click on your newly created macro button "ATLAS".
- 3) The DxAtlas is now loading, as well as the DDE routine Mix2DxAtlas.exe
- 4) After some seconds a smaller DxAtlas window pops up in the upper left corner.
- 5) Enlarge the atlas to the whole screen.
- 6) To get the Mix screen back, click the Mix Butterfly at the very bottom. Click a couple of times to watch MixW and DxAtlas screens toggling.

### **Daily work with DxAtlas and MixW:**

Use MixW as usual. Select a station in the waterfall and click on the callsign in the RX window. As soon as you click the call, data will automatically be transferred to the DxAtlas. To actually see the result of this transaction, toggle the screens by clicking the Mix Butterfly at the bottom of the screen. Now you will see the "DX" station placed correctly on the world map.

Of course the station is placed in the middle of a Prefix area. But if you, for instance, copy your Callbook CD to your hard disk, latitude and longitude data for the station in question (if present in callbook) will be transferred to DxAtlas as well. The station will then be placed right on spot in the map.

## **Other Programs**

---

**By Denis Nechitailov, UU9JDR updated by Colin Bell**

MixW provides a DDE interface to pass data to other programs. This is the list of available data items to transfer:

<b><u>Entity</u></b>	<b><u>Server</u></b>	<b><u>Topic</u></b>	<b><u>Item</u></b>
Your call	MixW	Info	MyCall
Your name	MixW	Info	MyName
Your QTH	MixW	Info	MyQth
Your Latitude	MixW	Info	MyLat
Your Longitude	MixW	Info	MyLong
Your Location	MixW	Info	MyLoc
Program name	MixW	Info	Program
MixW version	MixW	Info	Version
QSO date	MixW	QSO	Date

QSO end date	MixW	QSO	EndDate
QSO time	MixW	QSO	Time
QSO end time	MixW	QSO	EndTime
Frequency, MHz	MixW	QSO	Mhz
Mode	MixW	QSO	Mode
Call	MixW	QSO	Call
Name	MixW	QSO	Name
QTH	MixW	QSO	Qth
Domain (state)	MixW	QSO	Domain
County	MixW	QSO	County
IOTA number	MixW	QSO	IOTA
DXCC prefix	MixW	QSO	DxccPrefix
WAZ zone	MixW	QSO	WAZ
ITU zone	MixW	QSO	ITU
Country	MixW	QSO	Country
Continent	MixW	QSO	Continent
Continent (full name)	MixW	QSO	LongCont
RST sent	MixW	QSO	RstSnt
Exch sent	MixW	QSO	ExchSnt
RST received	MixW	QSO	RstRcv
Exch received	MixW	QSO	ExchRcv
QSL manager	MixW	QSO	Manager
QSL message	MixW	QSO	QSLmsg
Notes	MixW	QSO	Notes
QSO is unsaved	MixW	QSO	Changed

Band	MixW	QSO	Band
QSO freq.	MixW	QSO	Khz
Azimuth	MixW	QSO	Az
Distance	MixW	QSO	Dist
Latitude, deg.	MixW	QSO	Lat
Longitude, deg.	MixW	QSO	Long
Locator	MixW	QSO	Loc
<QSOCMDDDE:txt>	MixW	QSO	Command
Zero beat freq, kHz	MixW	CAT	Khz
PTT state	MixW	CAT	PTT
<CATCMDDDE:txt>	MixW	CAT	Command

If the Callbook dialogue is open the following list of items is available for use:

<u>Server</u>	<u>Topic</u>	<u>Item</u>
MixW	Callbook	Call
MixW	Callbook	FirstName
MixW	Callbook	LastName
MixW	Callbook	MiddleName
MixW	Callbook	Suffix
MixW	Callbook	City
MixW	Callbook	Zip
MixW	Callbook	State
MixW	Callbook	LicClass
MixW	Callbook	LicDate
MixW	Callbook	LicExp
MixW	Callbook	Longitude
MixW	Callbook	Latitude

MixW	Callbook	AreaCode
MixW	Callbook	County
MixW	Callbook	TimeZone
MixW	Callbook	DayOfBith
MixW	Callbook	DxccCountry
MixW	Callbook	PostalCountry
MixW	Callbook	PrevCall
MixW	Callbook	PrevClass
MixW	Callbook	VanityCall
MixW	Callbook	Comment
MixW	Callbook	FaxNr
MixW	Callbook	Email
MixW	Callbook	Code
MixW	Callbook	Street
MixW	Callbook	ProcessDate
MixW	Callbook	GridSquare
MixW	Callbook	TransactionType
MixW	Callbook	QslManager
MixW	Callbook	MailingAddressCountry
MixW	Callbook	Homepage
MixW	Callbook	VanityFlag

**Using DDE for printing QSL cards.**

See MixW QSL card test.doc file from MixW directory. This file shows a sample QSL card. Names, QTHs and other data is automatically updated in the Microsoft Word document when you change them in MixW. Normally, current QSO is shown. To print a previous QSO, select it from the list in Search Results dialog.



# UU9JDR/A

Denis in Kiev

To radio: **RN6AM** Arkady Krasnodar

Date	UTC	Band	Mode	RST
30-Jul-2001	12:06	14.1 MHz	MT63	599

*Thanks for the nice QSO! 73! I use MixW version 2.0 RC10.*

Three files are required for printing QSL cards. They are:

MixW DDE test.doc

MixW QSL card test.doc

StarOffice MixW DDE test.sdw for Star Office and OpenOffice Writer up to V3.1.

For the latest OpenOffice Writer see [Using the MixW program to create a QSL card to print or to email](#)

If any of these files are not in your MixW data folder download them as follows:

Download the Microsoft Word DDE test file:

[mixw.net/files/MixW DDE test.doc](http://mixw.net/files/MixW DDE test.doc)

and the MixW DDE test.doc and sample QSL card:

[mixw.net/files/MixW QSL card test.doc](http://mixw.net/files/MixW QSL card test.doc)

Download Sun Star Office notes:

[mixw.net/files/StarOffice MixW DDE test.sdw](http://mixw.net/files/StarOffice MixW DDE test.sdw)

### Using DDE to pass QSO data to external loggers.

Here is a sample application to pass data to DXBase 2002 software.

<http://www.dibase.com>

Download Visual Basic source code and EXE file:

<http://mixw.net/files/Mix2Dibase4.zip>.

(All Visual Basic EXE files require Visual Basic 6 DLLs to be present in your system.)

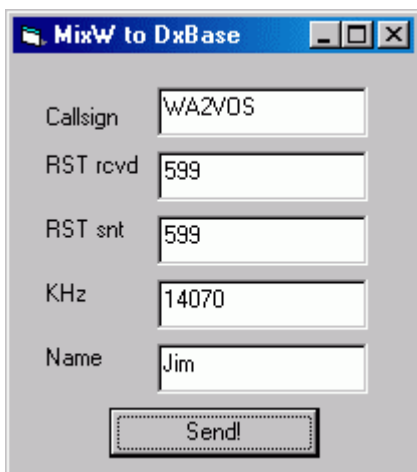

Click Send! button to send data to Dibase.

Or, create keyboard macro (for example, for F2 key):

Macro: F2

Label: Save

Text: <QSOCMDDDE:WRITE><QSOCMDDDE:>

Then use F2 to get the same result.

MixW also automatically generates <QSOCMDDDE:Send> when you press Save QSO button, and <QSOCMDDDE:Remove> when you press Remove QSO button.

### Using DDE to pass data to external maps.

Here is a sample application to pass data to DX Atlas software ([www.dxatlas.com](http://www.dxatlas.com)).

<http://www.dxatlas.com/>.

Download Visual Basic source code and EXE file:

<http://mixw.net/files/Mix2DxAtlas1.zip>.

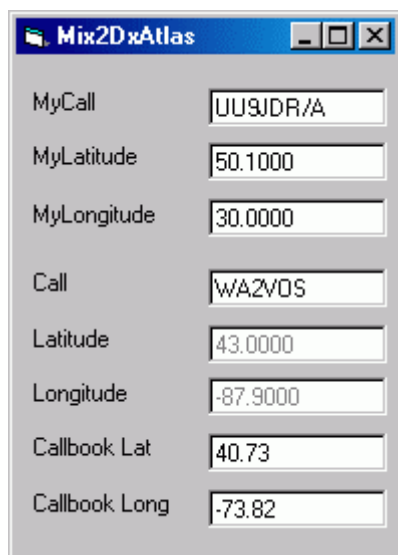

This sample program plots your own and other operator's position on the map. If you are using a callbook and it contains the other operator's coordinates, they will be used instead of approximate ones calculated from his callsign.

### Using DDE to switch/rotate antennas.

Download Visual Basic source code and EXE file:

<http://mixw.net/files/MixAntSw1.zip>.

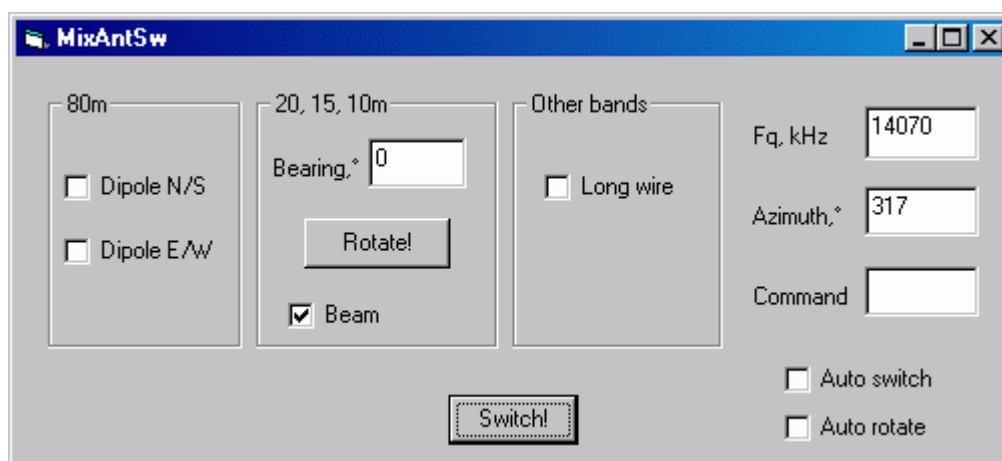

Suppose you have two perpendicular dipoles for 80m (North/South and East/West), a multiband beam for 20,15, and 10m and a long wire antenna for other bands.

This program demonstrates the possibility of automatic switching between all your three antennas and rotating the beam.

Click Switch! button to switch the antennas depending on the current frequency (80m dipoles also depend on the azimuth).



Click Rotate! to rotate the beam to the other station direction.

To initiate switching and rotating from MixW window, create two keyboard macros (e.g. F3 and F4):

Macro: F3

Label: Switch

Text: <CATCMDDDE:SWITCH><CATCMDDDE:>

Macro: F4

Label: Rotate

Text: <CATCMDDDE:ROTATE><CATCMDDDE:>

Now F3 will switch antennas, and F4 will rotate the beam.

Check "Auto switch" and "Auto rotate" to start switching and rotating immediately when the frequency or direction changes.

### Custom Callbooks

Using external DLL driver, it is now possible to use callbooks not directly supported by MixW.

### Writing callbook drivers in C language.

Download C++ source code and DLL file:

<http://mixw.net/files/MixCallBook1.zip>.

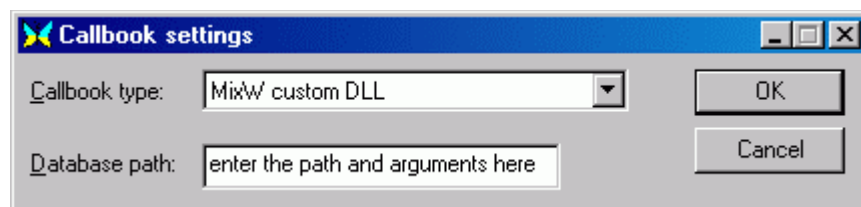

Place MixCallBook.dll file to MixW directory. Then open Callbook Settings dialog and select "MixW custom DLL" as callbook type. Enter the database path and other data passed to the DLL (not needed in this sample).

This sample DLL does not contain an actual database and returns data only for UU9JDR (yes, megalomania). But it could be easily extended to support a real database file. See included C++ files for details.

### Writing callbook drivers in Visual Basic.

Using a "bridge" DLL written in C language, it's possible to use Visual Basic ActiveX DLL as a callbook driver.

Download C++ and Visual Basic source code and DLLs:

<http://mixw.net/files/MixActiveXCb1.zip>.

Copy both DLLS (MixActiveXCallBook.dll and MixCallBook.dll) from the ZIP file to the MixW directory, then register ActiveX DLL by typing

```
regsvr32 MixActiveXCallBook.dll
```

Now choose the "MixW custom DLL" as Callbook type in Callbook Settings dialog to activate the "bridge" DLL.

This sample Visual Basic ActiveX DLL opens MsgBox windows in response to initializing DLL, it's deinitializing, and callsign lookups.

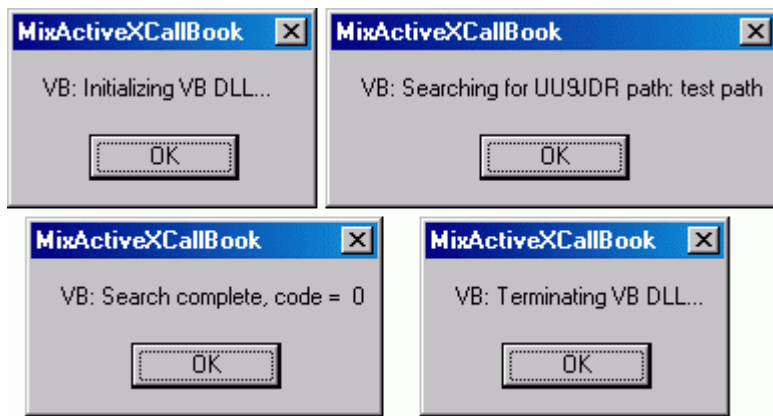

It also returns data in response to searching for UU9JDR.

You do not need to modify the MixActiveXCallBook.dll written in C language. Add your code to three Visual Basic functions to support your callbook database, it's easy:

```
Private Sub Class_Initialize()  
' Add your initializing code here  
...  
End Sub  
Private Sub Class_Terminate()  
' Add your terminating code here  
...  
End Sub
```

```
Public Function LookupCall(Path As String, Callsign As String, ByRef Info As String) As Long  
' Add your lookup code here
```

```
...  
End Sub
```

See sample Visual Basic project from VB directory of the ZIP file for details.

### ActiveX Use and Calls

<u>Return</u>	<u>Call</u>	<u>Parameter(s)</u>
long	PTT	
double	FqA	
double	FqB	
double	AudioFq	
double	Azimuth	
double	Elevation	
BSTR	Mode	
BSTR	GetQsoData(	long index)
long	GetQsoCnt()	
void	SetContestScore(	BSTR Score)

void	SetStatInfo(	BSTR Info)
long	AXSend(	IUnknown* pData long iCnt long iType)
long	AXReceive(	IUnknown* pData long iBufLen long iType)
BSTR	AXReceiveString()	
long	AXSendString(	BSTR text)
void	ExecuteMacros(	BSTR macros)
BSTR	ExtReceive()	
void	SetQsoData(	long index BSTR szData)
long	GetSquelch()	

**Index values for SetQsoData and GetQsoData**

<u>SetQsoData</u>		<u>GetQsoData</u>	
Index Value	Log item to send	Index Value	Log item returned
0	Call	0	Mode
1	Name	1	Fq RX
2	RST Rx	2	FQ TX
3	QTH	3	Date
4	Notes	4	Time
5	RST Snt	5	Call
6	Exch Rx	6	RST Snt
7	Domain	7	Exch Snt

8	County	8	RST Rx
9	Manager	9	Exch Rx
10	Locator	10	Name
11	Exch Snt	11	QTH
12	IOTA	12	Notes
13		13	Domain
14		14	County
15		15	IOTA
16		16	Manager
17		17	End Date
18		18	End Time
19		19	Locator
20		20	

**Note:** The latest Microsoft development environments do not permit generation of DDE code.

## Using the Spectrum

---

**By Jim Jaffe, WA2VOS**

MixW offers two separate displays for tuning purposes which would be the ubiquitous Waterfall and the Deluxe display which is the Spectrum display. The essential difference is the WATERFALL is NOT a REAL TIME display but an average of the signals and any attempt to tune a signal in with that display using the VFO knob results in a blurred trace in the direction that the VFO knob is turned.

With the Spectrum display there are actually two signals displayed: the Peak is the real time display, and the Average Curve is the Peak in Average time. Keep that Average curve in mind as that will come in handy later on. You can toggle between the Waterfall and the Spectrum Display using the keyboard shortcut "ALT-W".

To set up the Spectrum go to the View menu and select the following items:

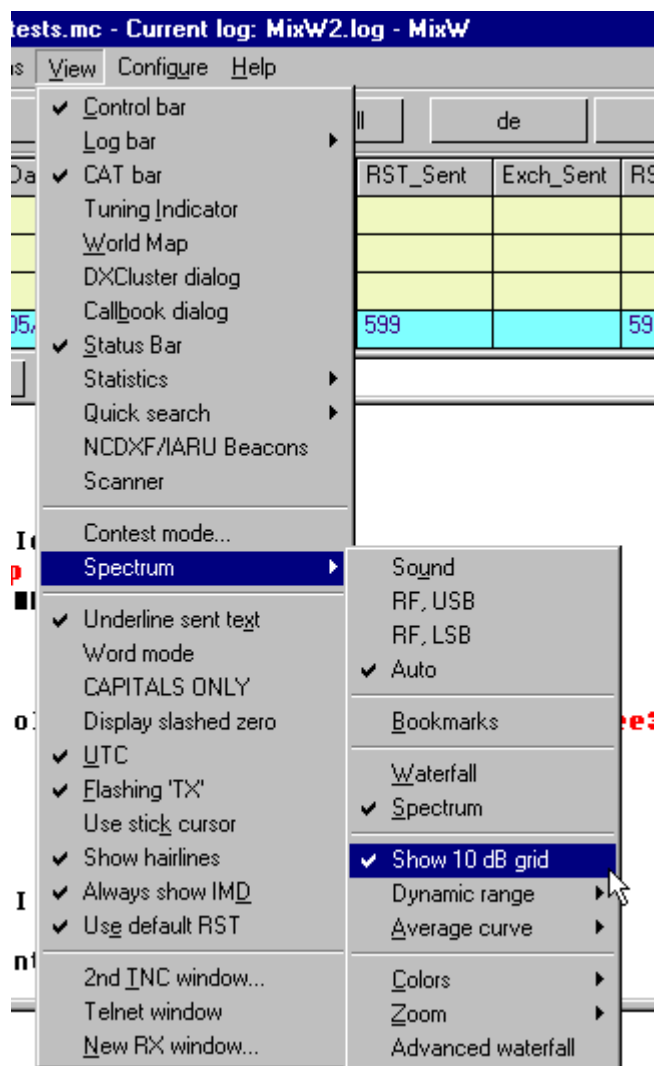

Scroll down to the Spectrum highlight and then Select Average Curve then Select Show 10DB grid. The colors are up to you. The colors in my illustrations are Orange for the Peak Curve, and Yellow for the Average Curve. The illustration below shows the Peak Curve as an inverted "V" in Orange, and the Average Curve as a Yellow "V".

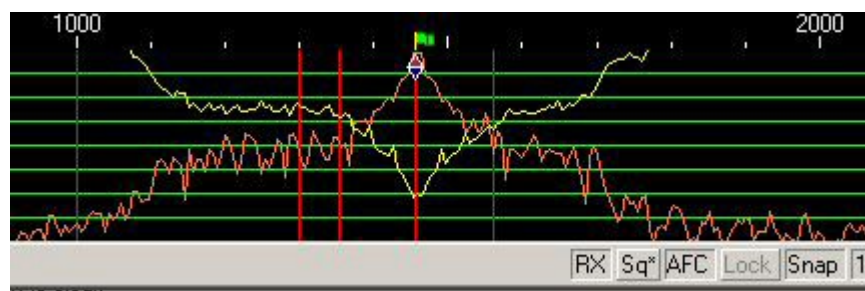

Using the Spectrum it is very easy to see the signal and be able to tune it. If you need to use the Notch Filters just put your cursor on each of the individual peaks one at a time, right click and choose Set Notch filter and you will have completely eliminated the offending signals. In the Spectrum display you can see exactly where they are in relation to the signal you're trying to receive.

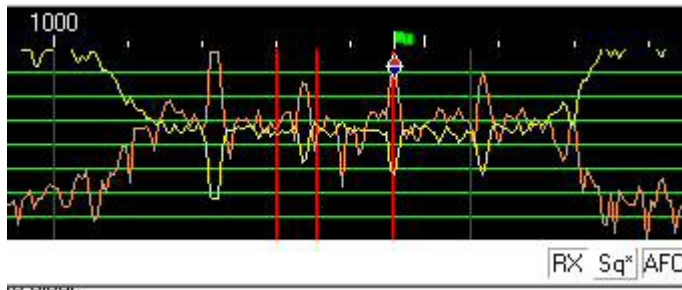

In the illustration you can see the filter skirts and how well you are using the filters to isolate the signal you want to copy. Working with the Spectrum display really makes it easy. Take a look at this illustration with a 500 Hz IF filter and center frequency about 1360 Hz

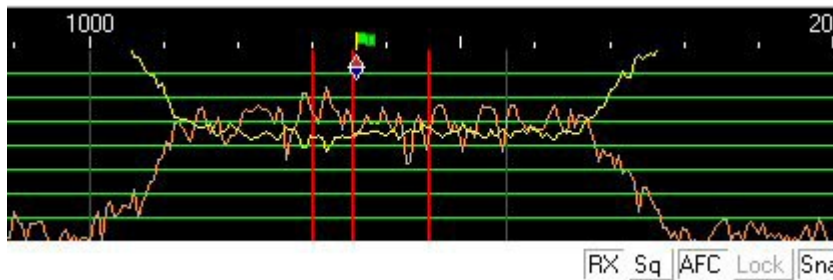

Tuning an MFSK signal is very difficult with the Waterfall as only the initial tone trace is visible. If you lose the sync you will have to wait until you can see a better trace. With the Spectrum you have to keep the multiple peaks in between the two Cursors. Once that is achieved you are printing the MFSK signal quite easily. The same applies to a RTTY Signal which this illustration depicts.

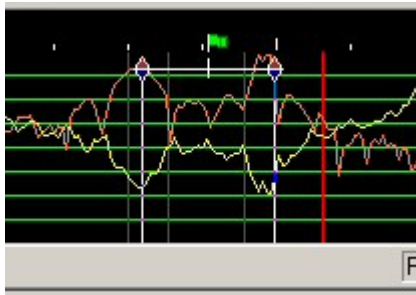

As you can see the Spectrum Display is so effective that I never use the Waterfall. I only use the Waterfall display to report Sidebands on the sending station's signal upon his/her request..

## Using the Waterfall

This topic is about using MixW without a CAT (computer control) interface, and understanding what is going on with the waterfall and the frequency markers. This Topic may be particularly useful for hams who are converting to MixW from other digital mode programs.

### How Hard Could This Be?

MixW makes using the digital modes so intuitive that it may not occur to you exactly what is happening on the screen in front of you until something unusual occurs. So let's look carefully at the process of tuning in a BPSK signal in MixW, assuming that your radio and computer are all hooked up and ready to go.

#### Step 1.

Start MixW and set your transceiver to 14,070,000 Hz. (14.070 MHz.), Upper Side Band (USB). If your waterfall is blank, go back to the Configuration and Set Up Section. If you have something in the waterfall, go to Configure | TRCVR CAT/PTT (in the MixW Menu) and click the "Display zero beat frequency" box to put a check mark there, and then click the OK button. Then select View | Spectrum | Auto. If Auto is not checked, click on it with the mouse to select it. Now right-click the mouse in the waterfall and select Zoom x2 from the pop up menu. The center of your waterfall and Status Bar should look something like the following illustration.

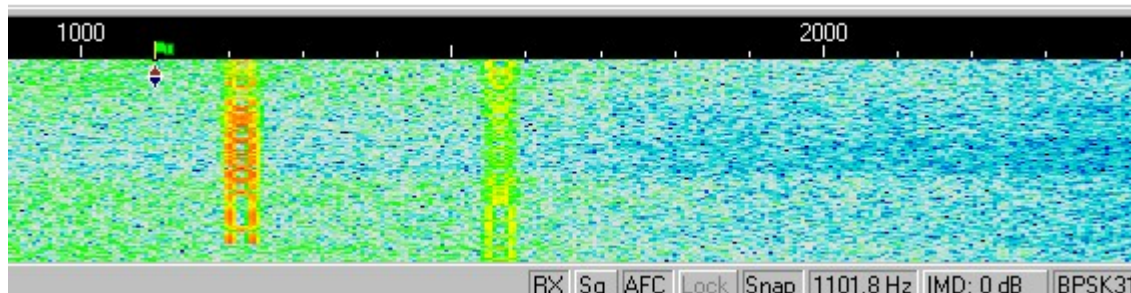

In this example there are two fairly strong BPSK31 signals in the waterfall, one just above 1200 Hz, and one at about 1580 Hz. You can also see the red and blue triangles with the green flag at 1100 Hz. In the status bar you can see that the mode is BPSK31, the RX, AFC, and Snap options are selected (pushed down), and the Squelch (Sq) and Lock options are not selected (are not pushed down).

If you move your mouse pointer into the waterfall and left click with the tip of the mouse pointer (arrow) in the center of the strongest signal, the green flag with the red and blue triangle will move to the center of the signal (about 1205 Hz in the example above), and the text of the QSO should start to print in the RX pane.

If the signal you are "printing" is a ham calling CQ, you can answer the call by left clicking with the mouse on the RX button in the status bar (which will then change to TX) and typing your outgoing text into the TX pane (between the RX pane and the Waterfall).

Now, if you only want to work casual 20 Meter PSK31 contacts, you've got it mastered. But probably you've got a few questions. For example, if you like to log the exact frequency of your QSOs, what frequency would you log for that contact at 1205 Hz on the Waterfall?

### Frequency

For both CW and SSB we are accustomed to simply using the dial setting as the frequency when we make a schedule, or log a QSO. This works because everything else is pretty much set by convention. With the digital modes the conventions are still developing, so you have to know what questions to ask.

The proper way to specify a digital frequency is as **the center of the RF signal**. If you look at a digital signal on your waterfall you can see where the center of the signal is because there is a little flag there! So the real question is: what is the RF frequency where the little flag is? Like so many things in ham radio, the answer is: "It depends". And what it depends on is the sideband.

### Sideband

The digital modes do NOT change sidebands when they change bands. In other words you ALWAYS use Upper Side Band (USB) for soundcard digital modes on all bands (at least until you get to the tricky stuff). So knowing that you will be using USB how do you find an RF frequency in the MixW waterfall?

You do a little arithmetic. You know that in SSB your radio dial shows the frequency of the suppressed carrier, and that for USB the audio signals will be at a frequency higher than the suppressed carrier. So, to calculate the RF frequency of the QSO in the example above, just add

the frequency of the suppressed carrier (transceiver frequency) to the audio frequency shown by the position of the flag on the MixW waterfall and you have the RF frequency of the signal (14.070,000 Hz plus 1,205 Hz gives 14,071,205 Hz. or 14.071.205 KHz in the example) to be logged for the QSO.

### Step 2.

But wait a minute. We are using a computer here, so why can't it do the arithmetic? MixW will do the arithmetic for you if you give it the information it needs. First select View | Spectrum | RF, USB to tell MixW you are using USB. Then select View | CAT bar. I know you don't have CAT, but this is how you tell MixW what frequency your transceiver dial is set to. Then click in the Fq: box, in the CAT Bar, type in the DIAL frequency from your transceiver (14070), and hit the enter key.

Now your waterfall should show the RF frequencies across the top, and you can see exactly what the center frequency of any signal is. Also, MixW will enter the frequency of the QSO properly into the Log as the center of the RF frequency. In the following illustration you can see that MixW entered 14070.882 KHz into the log.

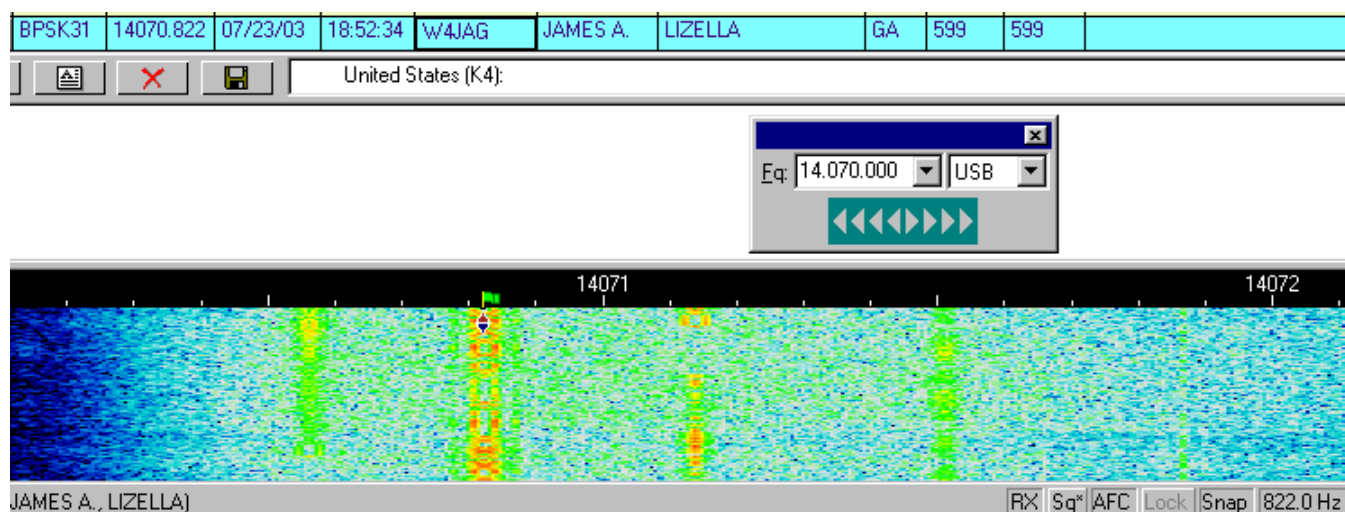

Sometimes it is necessary to reselect the mode (BPSK31 in this example) to get the proper frequency in the log.

**NOTE:** Every time you change your transceiver dial you must tell MixW what the new frequency is by typing it into the CAT Bar. I recommend, therefore, that you keep the CAT bar on the screen even though you are not using CAT.

### Step 3.

There is one more aspect of frequency and sideband choice that you need to know about. Up there in Step 1 you were told that you should always use USB for the soundcard digital modes, regardless of the band you are using. That probably bothered you a little, because you know that when operating SSB you use LSB for 160 - 40 meters, and USB for the others. You may also remember, if you have been a ham for a while, that in the past RTTY normally used LSB.

You are remembering correctly, but things have changed with modern transceivers and the use of computer programs and soundcards for the digital modes, including RTTY. Again, MixW will take care of most cases for you if you give it the information it needs, which you have already done in Step 2. Here is what a RTTY signal looks like in MixW. Note that the center of the transmitted signal (the green flag), 14085.275 KHz is shown in the log entry. The transceiver is set to 14084 KHz, and USB.



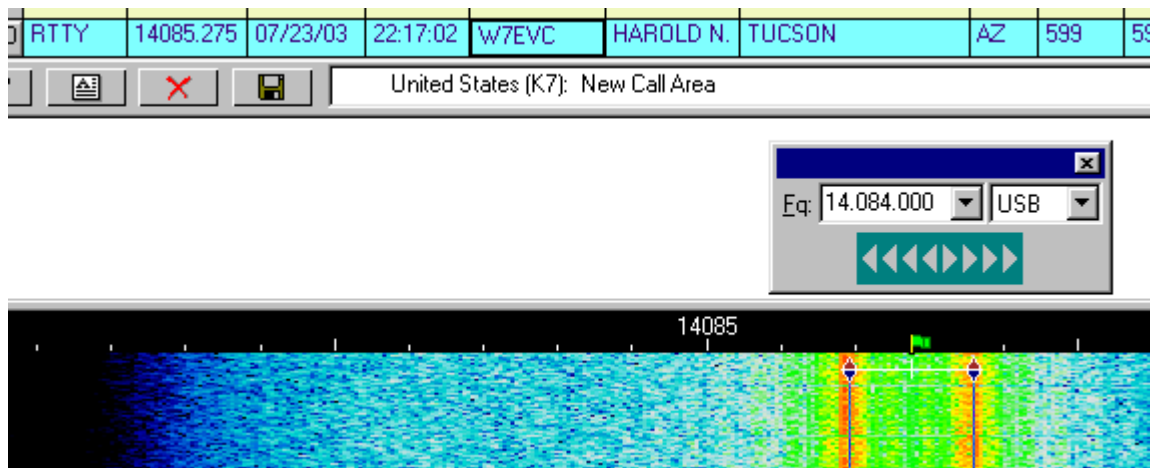

### Inversion

When using a traditional hardware TNC, RTTY is almost always operated in the LSB mode, utilizing a 170 Hz shift between the MARK and SPACE tones, with the MARK tone being the higher in frequency. If MixW is set on "RF, LSB" it will set the Mark tone as the higher tone. However, if MixW is set on "RF, USB" then the Mark tone will be set to the lower tone. (You can **think of this as an automatic inversion** if you like). In other words, if MixW is configured correctly (it needs to know if you are using LSB or USB) then it will automatically adjust your Mark and Space tones for you.

**Note:** This feature works differently in MixW than most other SoundCard digital programs so it may be confusing at first. Other modes that utilize the inversion feature are QPSK31, MFSK16, AMTOR, Hellschreiber, THROB, and FAX. **In MixW, "Inverted" means to invert the Mark and Space tones from the normal operating standards of the active mode.** If you are tuned to a strong signal, but copying only garbage, try opening the Mode Settings Dialog and clicking the Inverted box to see if the signal can be copied in the inverted mode.

### Step 4.

Now for the big step. Once you have experimented with MixW by working a few QSOs you should go to the Operation Section and read the General Operation Topic all the way through. You may not understand some of it the first time through, but it will ring a bell later on when you are trying out all the great features in MixW.

### Waterfall Colors

The waterfall colors maybe selected for personal preferences.

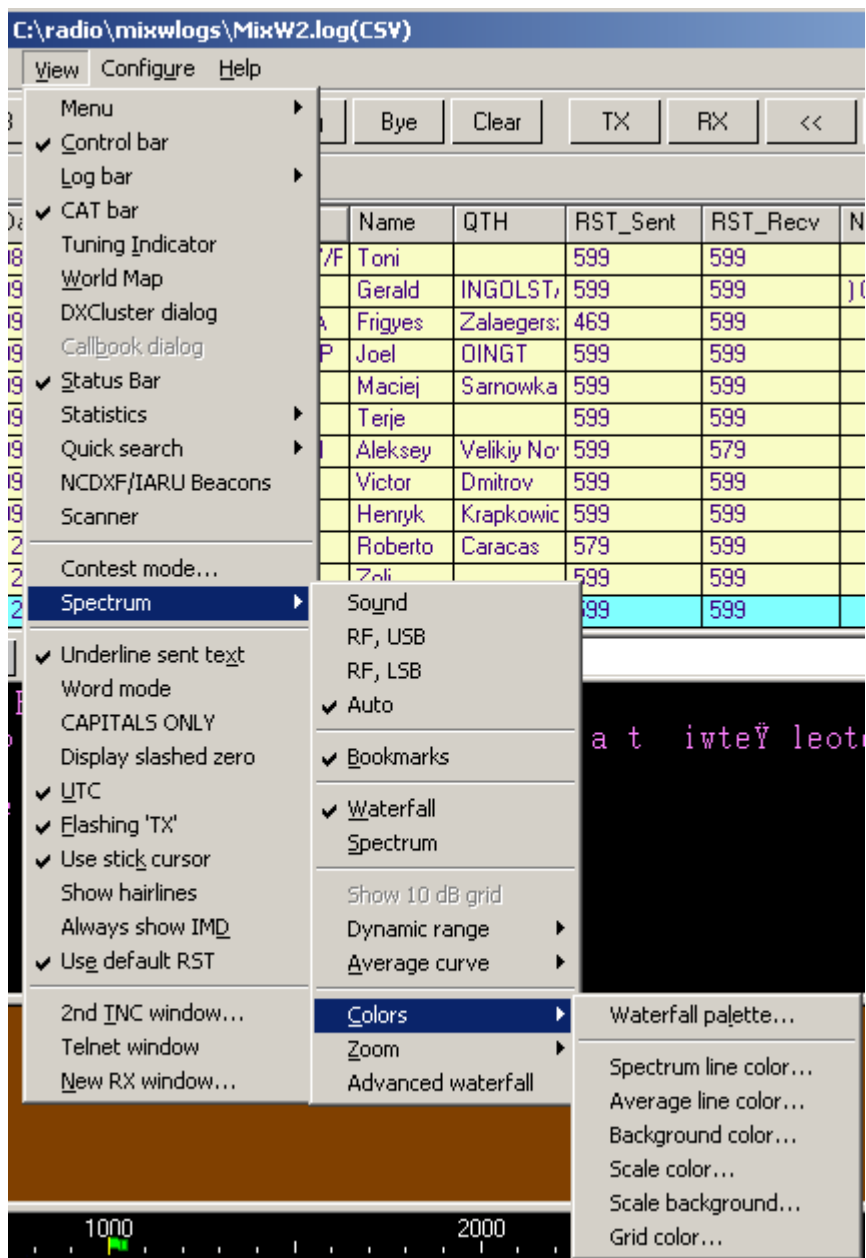

Select the Waterfall Palette set up from View|Spectrum|Colors menu  
 This window is confusingly entitled Spectrum colors but does not affect the spectrum display.

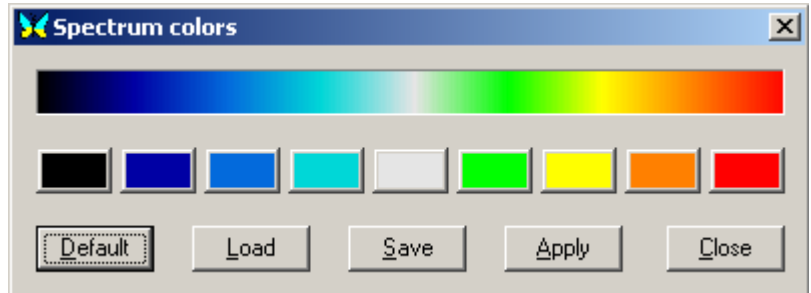

The nine buttons in the centre row are used to select the colour to be used for the different strength of signal in the waterfall display. The left button is the weakest and the right the strongest. Once the choices are made and the Apply button has been clicked on, the selection can be saved to a file that will have a .pal suffix.

MixW will remember these palette settings but archive your palette files.

Backup of the default settings is unnecessary. Click Default then Apply and the default settings will be restored.

